

CE Test Report

Product Name : Printer

Model No. : APXXYYY

Applicant : AVISION INC.

Address : No.20, Creation Rd. I, Science Park,
Hsinchu, Taiwan 300 R.O.C.

Date of Receipt : 2017/04/14

Report No. : 1740388R-ITCEP01V01

Issued Date : 2017/05/31

Report Version : V1.0



The test results relate only to the samples tested.

The test results shown in the test report are traceable to the national/international standard through the calibration of the equipment and evaluated measurement uncertainty herein.

This report must not be used to claim product endorsement by TAF or any agency of the Government.

The test report shall not be reproduced except in full without the written approval of DEKRA Testing and Certification Co., Ltd.

Test Report Certification

Issued Date : 2017/05/31

Report No. : 1740388R-ITCEP01V01



Product Name : Printer

Applicant : AVISION INC.

Address : No.20, Creation Rd. I, Science Park, Hsinchu, Taiwan
300 R.O.C.

Manufacturer : 1. AVISION INC.
2. AVISION(Suzhou) CO., LTD

Model No. : APXXYYY

EUT Voltage : AC 230V/50Hz

Trade Name :

Applicable Standard : EN 55032: 2015 Class B
EN 61000-3-2: 2014
EN 61000-3-3: 2013
EN 55024: 2010+A1: 2015

Test Result : Complied

Laboratory Name : Hsin Chu Laboratory

Address : No. 75-2, 3rd Lin, WangYe Keng, Yonghxing Tsuen,
Qionglin Shiang, Hsinchu County 307, Taiwan (R.O.C.)
TEL: +886-3-592-8858 / FAX: +886-3-592-8859

Documented By :

(Carol Tsai / Senior Engineering Adm. Specialist)

Reviewed By :

(Eden Chen / Engineer)

Approved By :

(Arthur Liu Deputy Manager)

Laboratory Information

We , **DEKRA Testing and Certification Co., Ltd.**, are an independent EMC and safety consultancy that was established the whole facility in our laboratories. The test facility has been accredited/accepted (audited or listed) by the following related bodies in compliance with ISO 17025, EN 45001 and specified testing scopes:

Taiwan R.O.C.	:	BSMI, NCC, TAF
USA	:	FCC
Japan	:	VCCI

The related certificate for our laboratories about the test site and management system can be downloaded from DEKRA Testing and Certification Co., Ltd. Web Site :

<http://www.dekra.com.tw/english/about/certificates.aspx?bval=5>

The address and introduction of DEKRA Testing and Certification Co., Ltd. laboratories can be founded in our Web site : http://www.dekra.com.tw/index_en.aspx

If you have any comments, Please don't hesitate to contact us. Our test sites as below:

- 1 No. 75-2, 3rd Lin, WangYe Keng, Yonghxing Tsuen, Qionglin Shiang, Hsinchu County 307, Taiwan (R.O.C.)
TEL:+886-3-592-8858 / FAX:+886-3-592-8859 E-Mail : info.tw@dekra.com
- 2 No.372, Sec. 4, Zhongxing Rd., Zhudong Township, Hsinchu County 31061, Taiwan
TEL: +886-3-582-8001 / FAX: +886-3-582-8958 E-Mail : info.tw@dekra.com
- 3 No.372-2, Sec. 4, Zhongxing Rd., Zhudong Township, Hsinchu County 31061, Taiwan
TEL: +886-3-582-8001 / FAX: +886-3-582-8958 E-Mail : info.tw@dekra.com

TABLE OF CONTENTS

Description	Page
1. General Information	7
1.1. EUT Description	7
1.2. Mode of Operation	8
1.3. Tested System Details	9
1.4. Configuration of Tested System	11
1.5. EUT Exercise Software	13
2. Technical Test.....	14
2.1. Summary of Test Result	14
2.2. List of Test Equipment	15
2.3. Measurement Uncertainty	19
2.4. Test Environment	21
3. Conducted Emissions(Main Terminals).....	22
3.1. Test Specification	22
3.2. Test Setup	22
3.3. Limit.....	22
3.4. Test Procedure	23
3.5. Deviation from Test Standard	23
3.6. Test Result	24
3.7. Test Photograph	40
4. Asymmetric mode Conducted Emissions.....	48
4.1. Test Specification	48
4.2. Test Setup	48
4.3. Limit.....	49
4.4. Test Procedure	50
4.5. Deviation from Test Standard	50
4.6. Test Result	51
4.7. Test Photograph	55
5. Radiated Emissions	57
5.1. Test Specification	57
5.2. Test Setup	57
5.3. Limit.....	58
5.4. Test Procedure	60
5.5. Deviation from Test Standard	60
5.6. Test Result	61
5.7. Test Photograph	93
6. Harmonic Current Emission	109

6.1.	Test Specification	109
6.2.	Test Setup	109
6.3.	Limit.....	109
6.4.	Test Procedure	111
6.5.	Deviation from Test Standard	111
6.6.	Test Result	112
6.7.	Test Photograph	128
7.	Voltage Fluctuation and Flicker	132
7.1.	Test Specification	132
7.2.	Test Setup	132
7.3.	Limit.....	132
7.4.	Test Procedure	133
7.5.	Deviation from Test Standard	133
7.6.	Test Result	134
7.7.	Test Photograph	142
8.	Electrostatic Discharge	146
8.1.	Test Specification	146
8.2.	Test Setup	146
8.3.	Limit.....	146
8.4.	Test Procedure	147
8.5.	Deviation from Test Standard	147
8.6.	Test Result	148
8.7.	Test Photograph	156
9.	Radiated Susceptibility.....	160
9.1.	Test Specification	160
9.2.	Test Setup	160
9.3.	Limit.....	160
9.4.	Test Procedure	161
9.5.	Deviation from Test Standard	161
9.6.	Test Result	162
9.7.	Test Photograph	170
10.	Electrical Fast Transient/Burst	174
10.1.	Test Specification	174
10.2.	Test Setup	174
10.3.	Limit.....	174
10.4.	Test Procedure	175
10.5.	Deviation from Test Standard	175
10.6.	Test Result	176

10.7.	Test Photograph	184
11.	Surge.....	190
11.1.	Test Specification	190
11.2.	Test Setup	190
11.3.	Limit.....	191
11.4.	Test Procedure	191
11.5.	Deviation from Test Standard	191
11.6.	Test Result	192
11.7.	Test Photograph	200
12.	Conducted Susceptibility.....	206
12.1.	Test Specification	206
12.2.	Test Setup	206
12.3.	Limit.....	207
12.4.	Test Procedure	207
12.5.	Deviation from Test Standard	207
12.6.	Test Result	208
12.7.	Test Photograph	216
13.	Power Frequency Magnetic Field.....	222
13.1.	Test Specification	222
13.2.	Test Setup	222
13.3.	Limit.....	222
13.4.	Test Procedure	222
13.5.	Deviation from Test Standard	222
13.6.	Test Result	223
13.7.	Test Photograph	231
14.	Voltage Dips and Interruption	235
14.1.	Test Specification	235
14.2.	Test Setup	235
14.3.	Limit.....	235
14.4.	Test Procedure	236
14.5.	Deviation from Test Standard	236
14.6.	Test Result	237
14.7.	Test Photograph	245
15.	Attachment	249
	EUT Photograph	249

1. General Information

1.1. EUT Description

Product Name	Printer
Trade Name	
Test Mode No.	APXXYYY

Component	
Scanner	1 Set. Cable: Shielded, 0.5m
USB Cable	Shielded, 1.8m, one ferrite core bonded
Power Cord	Non-Shielded, 1.8m

Note:

1. This EUT is a Printer.
2. The model number APXXYYY; XX: 00~30; Y: 0~9,A~Z,- or blank; for different strategy of marketing.

1.2. Mode of Operation

DEKRA has verified the construction and function in typical operation. All the test modes were carried out with the EUT in normal operation, which was shown in this test report and defined as:

Pre-Test Mode	
Mode 1: PC Printing (110W)	
Mode 2: LAN Printing (110W)	
Mode 3: Document Printing (110W)	
Mode 4: WiFi Printing (110W)	
Mode 5: PC Printing (72W)	
Mode 6: LAN Printing (72W)	
Mode 7: Document Printing (72W)	
Mode 8: WiFi Printing (72W)	
Final Test Mode	
Emission	Mode 1: PC Printing (110W)
	Mode 2: LAN Printing (110W)
	Mode 3: Document Printing (110W)
	Mode 4: WiFi Printing (110W)
	Mode 5: PC Printing (72W)
	Mode 6: LAN Printing (72W)
	Mode 7: Document Printing (72W)
	Mode 8: WiFi Printing (72W)
Immunity	Mode 1: PC Printing (110W)
	Mode 2: LAN Printing (110W)
	Mode 3: Document Printing (110W)
	Mode 4: WiFi Printing (110W)
	Mode 5: PC Printing (72W)
	Mode 6: LAN Printing (72W)
	Mode 7: Document Printing (72W)
	Mode 8: WiFi Printing (72W)

1.3. Tested System Details

The types for all equipment, plus descriptions of all cables used in the tested system (including inserted cards) are:

EMI (Conducted Emissions/Power Harmonics/Voltage Fluctuation and Flicker)					
EMS					
Test Mode:		Mode 1: PC Printing (110W) Mode 2: LAN Printing (110W) Mode 3: Documents Printing (110W) Mode 5: PC Printing (72W) Mode 6: LAN Printing (72W) Mode 7: Documents Printing (72W)			
Product	Manufacturer	Model No.	Serial No.	Power Cord	
1	Printer	HP	C9007A	MY3621M0PS	Non-Shielded, 3.7m, one ferrite core bonded
2	Notebook PC	Lenovo	B590	WB15330072	Non-Shielded, 1.8m, one ferrite core bonded
3	USB 2.0 Flash Memory	Apacer	AH223	N/A	--
4	USB Mouse	Logitech	M-UV83	LZE35006052	--
5	WiFi Router	D-Link	DIR-619L	25738833	Non-Shielded, 1.8m
Test Mode:		Mode 4: WiFi Printing (110W) Mode 8: WiFi Printing (72W)			
Product	Manufacturer	Model No.	Serial No.	Power Cord	
1	Printer	HP	C9007A	MY3621M0PS	Non-Shielded, 3.7m, one ferrite core bonded
2	Notebook PC	Lenovo	B590	WB15330072	Non-Shielded, 1.8m, one ferrite core bonded
3	USB 2.0 Flash Memory	Apacer	AH223	N/A	--
4	USB Mouse	Logitech	M-UV83	LZE35006052	--
5	WiFi Router	D-Link	DIR-619L	25738833	Non-Shielded, 1.8m
6	WiFi Dongle	AMPAK	WUBR-626GN	6CFAA7DFAF88	--

EMI (Radiated Emissions)					
Test Mode:		Mode 1: PC Printing (110W) Mode 2: LAN Printing (110W) Mode 3: Documents Printing (110W) Mode 5: PC Printing (72W) Mode 6: LAN Printing (72W) Mode 7: Documents Printing (72W)			
Product		Manufacturer	Model No.	Serial No.	Power Cord
1	Printer	HP	C9007A	MY3621M0PS	Non-Shielded, 3.7m, one ferrite core bonded
2	Notebook PC	Lenovo	B590	WB15330072	Non-Shielded, 1.8m, one ferrite core bonded
3	USB 2.0 Flash Memory	Apacer	AH223	N/A	--
4	USB Mouse	Microsoft	Comfort Optical Mouse 1000	1005895-0	--
5	WiFi Router	D-Link	DIR-619L	25738833	Non-Shielded, 1.8m
Test Mode:		Mode 4: WiFi Printing (110W) Mode 8: WiFi Printing (72W)			
Product		Manufacturer	Model No.	Serial No.	Power Cord
1	Printer	HP	C9007A	MY3621M0PS	Non-Shielded, 3.7m, one ferrite core bonded
2	Notebook PC	Lenovo	B590	WB15330072	Non-Shielded, 1.8m, one ferrite core bonded
3	USB 2.0 Flash Memory	Apacer	AH223	N/A	--
4	USB Mouse	Microsoft	Comfort Optical Mouse 1000	1005895-0	--
5	WiFi Router	D-Link	DIR-619L	25738833	Non-Shielded, 1.8m
6	WiFi Dongle	AMPAK	WUBR-626GN	6CFAA7DFAF88	--

1.4. Configuration of Tested System

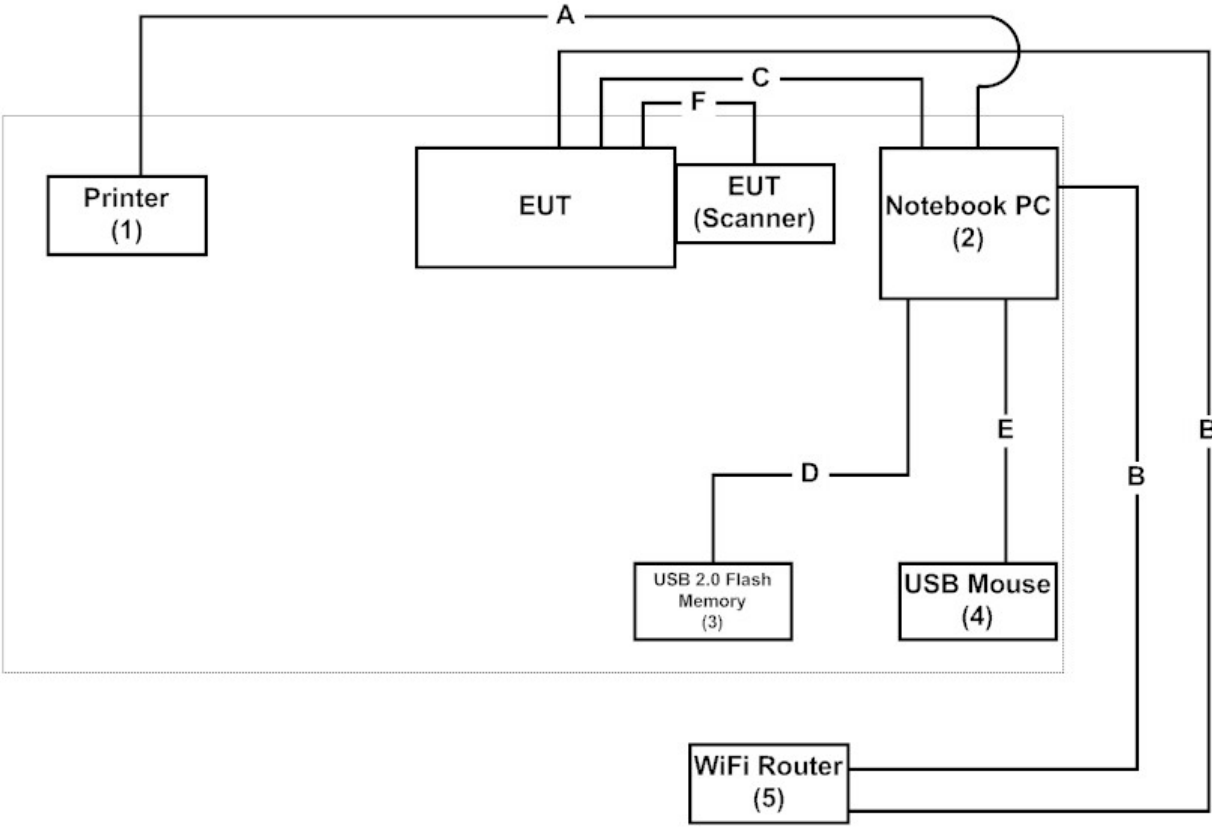
Test Mode:	Mode 1: PC Printing (110W) Mode 2: LAN Printing (110W) Mode 3: Documents Printing (110W) Mode 5: PC Printing (72W) Mode 6: LAN Printing (72W) Mode 7: Documents Printing (72W)	
Connection Diagram		
		
Signal Cable Type		Signal cable Description
A	Printer Cable	Shielded, 1.8m
B	LAN Cable	Non-Shielded, 10m, 2 PCS
C	USB Cable	Shielded, 1.8m, one ferrite core bonded.
D	USB 2.0 Flash Memory Cable	Non-Shielded, 1.2m
E	USB Mouse Cable	Shielded, 1.6m
F	USB Cable	Shielded, 0.5m

Test Mode:	Mode 4: WiFi Printing (110W) Mode 8: WiFi Printing (72W)
------------	---

Connection Diagram

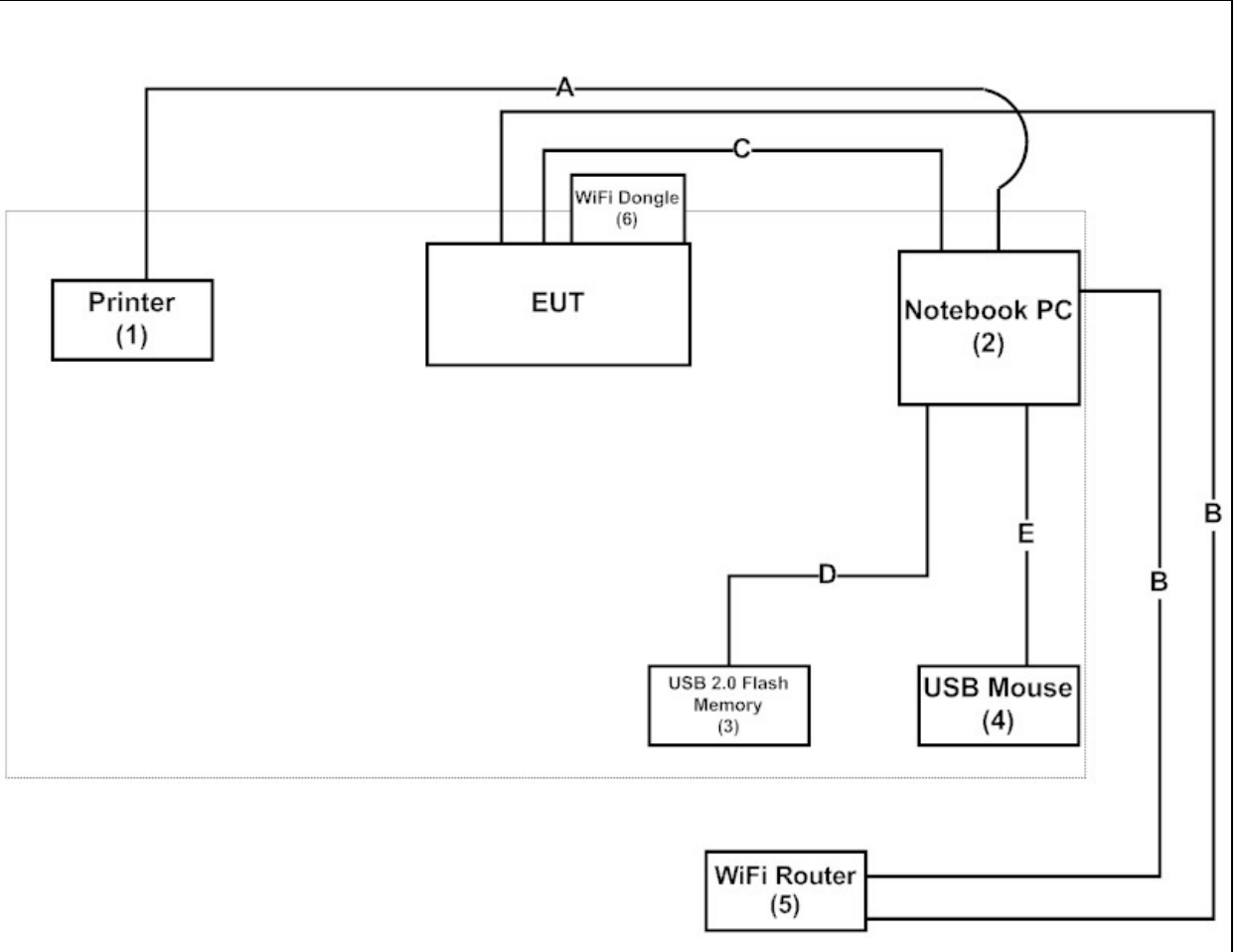

Signal Cable Type		Signal cable Description
A	Printer Cable	Shielded, 1.8m
B	LAN Cable	Non-Shielded, 10m, 2 PCS
C	USB Cable	Shielded, 1.8m, one ferrite core bonded.
D	USB 2.0 Flash Memory Cable	Non-Shielded, 1.2m
E	USB Mouse Cable	Shielded, 1.6m

1.5. EUT Exercise Software

1	Test system is in accord with EUT user manual (refer to 1.4 configuration of tested system)
2	Turn on the power of all equipment.
3	Boot the Notebook PC from Hard Disk.
4	Notebook PC reads test software from disk and then sent to EUT.
5	Scanner scan data and then sent to EUT.
6	Scanner receive data from WiFi dongle and then sent to EUT.
7	The EUT will start to operate and print the data.
8	Repeat the above procedure (4) to (7).

2. Technical Test

2.1. Summary of Test Result

- No deviations from the test standards
 Deviations from the test standards as below description:

Emission				
Performed Item	Normative References	Test Performed	Deviation	Test Site
Conducted Emissions	EN 55032: 2015	Yes	No	1
Asymmetric mode Conducted Emissions	EN 55032: 2015	Yes	No	1
Radiated Emissions	EN 55032: 2015	Yes	No	1
Conducted Differential Voltage Emissions	EN 55032: 2015	No	No	1
Power Harmonics	EN 61000-3-2: 2014	Yes	No	1
Voltage Fluctuation and Flicker	EN 61000-3-3: 2013	Yes	No	1

Immunity				
Performed Item	Normative References	Test Performed	Deviation	Test Site
Electrostatic Discharge	IEC 61000-4-2 Ed. 2.0: 2008	Yes	No	1
Radiated susceptibility	IEC 61000-4-3 Ed. 3.2: 2010	Yes	No	1
Electrical fast transient/burst	IEC 61000-4-4 Ed. 3.0: 2012	Yes	No	1
Surge	IEC 61000-4-5 Ed. 3.0: 2014	Yes	No	1
Conducted susceptibility	IEC 61000-4-6 Ed. 4.0: 2013	Yes	No	1
Power frequency magnetic field	IEC 61000-4-8 Ed. 2.0: 2009	Yes	No	1
Voltage dips and interruption	IEC 61000-4-11 Ed. 2.0: 2004	Yes	No	1

Note: Test Site information refers to Laboratory Information.

2.2. List of Test Equipment

Conducted Emissions / SR2 (Mode 1~4)

Instrument	Manufacturer	Model No.	Serial No.	Next Cal. Date
Artificial Mains Network	R&S	ENV4200	848411/010	2017/01/20
Coaxial Cable	Harbour	RG-400	SR2	2016/08/14
LISN	R&S	ENV216	100092	2016/08/17
Test Receiver	R&S	ESCS 30	825442/014	2016/07/16
Quietek EMI system	Quietek	Version 2.2	SR2	N/A

Conducted Emissions/ SR3 (Mode 5~8)

Instrument	Manufacturer	Model No.	Serial No.	Next Cal. Date
LISN	R&S	ENV216	100096	2016/07/27
LISN	R&S	ESH3-Z5	836679/022	2016/11/30
Test Receiver	R&S	ESCS 30	825442/017	2017/01/04
Coaxial Cable	Harbour	RG-400	SR3	2016/08/14
Quietek EMI system	Quietek	Version 2.2	SR3	N/A

Asymmetric mode Conducted Emissions (Telecommunication Ports) / SR2

Instrument	Manufacturer	Model No.	Serial No.	Next Cal. Date
ISN	Teseq	ISN T800	30885	2016/10/15
Artificial Mains Network	R&S	ENV4200	848411/010	2017/01/20
Coaxial Cable	Harbour	RG-400	SR2	2016/08/14
LISN	R&S	ENV216	100092	2016/08/17
Test Receiver	R&S	ESCS 30	825442/014	2016/07/16
Quietek EMI system	Quietek	Version 2.2	SR2	N/A

Radiated Emissions / Site3 (Under 1GHz)

Instrument	Manufacturer	Model No.	Serial No.	Next Cal. Date
Bilog Antenna	Schaffner	CBL6112B	2797	2016/08/14
Spectrum Analyzer	Advantest	R3132	100803278	2016/11/04
Test Receiver	R&S	ESCS 30	836858/022	2017/01/14
Coaxial Switch	Anritsu	MP59B	6201464326	2016/08/14
Coaxial Cable	Belden	Belden 9913	Site3	2016/08/14
Quietek EMI system	Quietek	Version 2.2	Site3	N/A

Radiated Emissions / CB1 (Above 1GHz)

Instrument	Manufacturer	Model No.	Serial No.	Next Cal. Date
k Type Cable	Huber+Suhner	Sucoflex 102	25623/2	2017/01/11
Double Ridged Guide Horn Antenna	Schwarzback	BBHA 9120	D743	2017/01/14
Horn Antenna	Schwarzbeck	BBHA 9170	203	2016/09/07
Pre-Amplifier	Quietek	AMF-4D-00501800-24-10P	1203577	2016/05/24
PSA Series Spectrum analyzer	Agilent	E4440A	MY46187335	2016/12/24
Signal & Spectrum Analyzer	R&S	FSV40	101049	2017/01/05
Quietek EMI system	Quietek	Version 2.2	CB1	N/A

Power Harmonics / SR1

Instrument	Manufacturer	Model No.	Serial No.	Next Cal. Date
EMC Emission Tester	EMC-PARTNER	HAR-1000-1P	109	2017/02/25

Voltage Fluctuation and Flicker / SR1

Instrument	Manufacturer	Model No.	Serial No.	Next Cal. Date
EMC Emission Tester	EMC-PARTNER	HAR-1000-1P	109	2017/02/25

Electrostatic Discharge / SR1

Instrument	Manufacturer	Model No.	Serial No.	Next Cal. Date
Electrostatic Simulator Discharge	NoiseKen	ESS-2002	ESS04Z3759	2016/07/23
Horizontal Coupling Plane (HCP)	QuieTek	HCP AL50	N/A	N/A
Vertical Coupling Plane (VCP)	QuieTek	VCP AL50	N/A	N/A

Radiated susceptibility / CB3

Instrument	Manufacturer	Model No.	Serial No.	Next Cal. Date
Field strength Meter	Narda	EMR-20C	080938-05	2016/07/26
Power Sensor	Boonton	51011-EMC	31507	2016/07/14
Power Sensor	Boonton	51011-EMC	34359	2016/07/14
RF Power Meter	Boonton	4232A	42201	2016/07/14
Signal Generator	R&S	SML03	103300	2017/03/08
Bilog Antenna	FRANKONIA	BTA-M	06001M	N/A
Horn Antenna	Schwarzbeck	BBHA 9120E	286	N/A
Directional Coupler	WERLATONE	C6021	28565	N/A
Directional Coupler	WERLATONE	C6187	28590	N/A
Power Amplifier	FRANKONIA	FLH200B	1022	N/A
Power Amplifier	FRANKONIA	FLG-50C	1009	N/A

Electrical fast transient / Burst / SR1

Instrument	Manufacturer	Model No.	Serial No.	Next Cal. Date
Clamper	HAEFELY	093 506.1	083 593-23	2016/10/27
EMC Immunity Tester	EMC-PARTNER	TRA2000	984	2017/01/14

Surge / SR1

Instrument	Manufacturer	Model No.	Serial No.	Next Cal. Date
Ultra Compact Generator	EM TEST	UCS 500-M4	1198-34	2016/10/27

Conducted susceptibility / SR4

Instrument	Manufacturer	Model No.	Serial No.	Next Cal. Date
Attenuator	Schaffner	INA2070-1	2112	N/A
CDN	Schaffner	CDN M016	16337	2017/01/19
CDN	Schaffner	CDN T400	16905	2017/01/19
CDN	Teseq	CDN T8-10	38994	2016/09/08
Immunity Injection Clamp	Schaffner	KEMZ801	15928	2017/01/19
Compact Immunity Test System	Teseq	NSG 4070B-80	41145	2016/11/11

Power frequency magnetic field / SR1

Instrument	Manufacturer	Model No.	Serial No.	Next Cal. Date
Magnetic Field Testing	Haefely	MAG100.1	080938-05	2016/09/30

Voltage dips and interruption / SR1

Instrument	Manufacturer	Model No.	Serial No.	Next Cal. Date
Ultra Compact Generator	EM TEST	UCS 500-M4	1198-34	2016/10/27

2.3. Measurement Uncertainty

Conducted Emissions

The measurement uncertainty is evaluated as ± 2.26 dB.

Asymmetric mode Conducted Emissions

The measurement uncertainty is evaluated as ± 1.88 dB.

Radiated Emissions (Under 1GHz)

The measurement uncertainty is evaluated as ± 3.43 dB.

Radiated Emissions (Above 1GHz)

The measurement uncertainty is evaluated as ± 3.65 dB.

Harmonic Current Emission

The measurement uncertainty is evaluated as 0.1%.

Voltage Fluctuation and Flicker

The measurement uncertainty is evaluated as $\pm 4\%$.

Electrostatic Discharge

As what is concluded in the document from Note2 of clause 5.4.6.2 of ISO/IEC 17025: 1999[2], the requirements for measurement uncertainty in ESD testing are deemed to have been satisfied, and the testing is reported in accordance with the relevant ESD standards. The immunity test signal from the ESD system meet the required specifications in IEC 61000-4-2 through the calibration report with the calibrated uncertainty for the waveform of voltage and timing as being $1.63 \% \cdot 10^{-10}$ and 2.76%.

Radiated susceptibility

As what is concluded in the document from Note2 of clause 5.4.6.2 of ISO/IEC 17025: 1999[2], the requirements for measurement uncertainty in RS testing are deemed to have been satisfied, and the testing is reported in accordance with the relevant RS standards. The immunity test signal from the RS system meet the required specifications in IEC 61000-4-3 through the calibration for the uniform field strength and monitoring for the test level with the uncertainty evaluation report for the electrical field strength as being 2.72 dB.

Electrical fast transient/burst

As what is concluded in the document from Note2 of clause 5.4.6.2 of ISO/IEC 17025: 1999[2], the requirements for measurement uncertainty in EFT/Burst testing are deemed to have been satisfied, and the testing is reported in accordance with the relevant EFT/Burst standards. The immunity test signal from the EFT/Burst system meet the required specifications in IEC 61000-4-4 through the calibration report with the calibrated uncertainty for the waveform of voltage, frequency and timing as being 1.63 %, 2.8×10^{-10} and 2.76%

Surge

As what is concluded in the document from Note2 of clause 5.4.6.2 of ISO/IEC 17025: 1999[2], the requirements for measurement uncertainty in Surge testing are deemed to have been satisfied, and the testing is reported in accordance with the relevant Surge standards. The immunity test signal from the Surge system meet the required specifications in IEC 61000-4-5 through the calibration report with the calibrated uncertainty for the waveform of voltage and timing as being 1.63 % and 2.76%.

Conducted susceptibility

As what is concluded in the document from Note2 of clause 5.4.6.2 of ISO/IEC 17025: 1999[2], the requirements for measurement uncertainty in CS testing are deemed to have been satisfied, and the testing is reported in accordance with the relevant CS standards. The immunity test signal from the CS system meet the required specifications in IEC 61000-4-6 through the calibration for unmodulated signal and monitoring for the test level with the uncertainty evaluation report for the injected modulated signal level through CDN and EM Clamp/Direct Injection as being 3.72 dB and 2.78 dB.

Power frequency magnetic field

As what is concluded in the document from Note2 of clause 5.4.6.2 of ISO/IEC 17025: 1999[2], the requirements for measurement uncertainty in PFM testing are deemed to have been satisfied, and the testing is reported in accordance with the relevant PFM standards. The immunity test signal from the PFM system meet the required specifications in IEC 61000-4-8 through the calibration report with the calibrated uncertainty for the Gauss Meter to verify the output level of magnetic field strength as being 2 %.

Voltage dips and interruption

As what is concluded in the document from Note2 of clause 5.4.6.2 of ISO/IEC 17025: 1999[2], the requirements for measurement uncertainty in DIP testing are deemed to have been satisfied, and the testing is reported in accordance with the relevant DIP standards. The immunity test signal from the DIP system meet the required specifications in IEC 61000-4-11 through the calibration report with the calibrated uncertainty for the waveform of voltage and timing as being 1.63 % and 2.76%.

2.4. Test Environment

Performed Item	Items	Required	Actual
Conducted Emissions	Temperature (°C)	15-35	25
	Humidity (%RH)	25-75	50
	Barometric pressure (mbar)	860-1060	950-1000
Asymmetric mode Conducted Emissions	Temperature (°C)	15-35	25
	Humidity (%RH)	25-75	50
	Barometric pressure (mbar)	860-1060	950-1000
Radiated Emissions	Temperature (°C)	15-35	22
	Humidity (%RH)	25-75	63
	Barometric pressure (mbar)	860-1060	950-1000
Power Harmonics	Temperature (°C)	15-35	25
	Humidity (%RH)	25-75	65
	Barometric pressure (mbar)	860-1060	950-1000
Voltage Fluctuation and Flicker	Temperature (°C)	15-35	25
	Humidity (%RH)	25-75	65
	Barometric pressure (mbar)	860-1060	950-1000
Electrostatic Discharge	Temperature (°C)	15-35	24
	Humidity (%RH)	30-60	51
	Barometric pressure (mbar)	860-1060	950-1000
Radiated susceptibility	Temperature (°C)	15-35	20
	Humidity (%RH)	25-75	52
	Barometric pressure (mbar)	860-1060	950-1000
Electrical fast transient/burst	Temperature (°C)	15-35	22
	Humidity (%RH)	25-75	53
	Barometric pressure (mbar)	860-1060	950-1000
Surge	Temperature (°C)	15-35	23
	Humidity (%RH)	10-75	50
	Barometric pressure (mbar)	860-1060	950-1000
Conducted susceptibility	Temperature (°C)	15-35	23
	Humidity (%RH)	25-75	52
	Barometric pressure (mbar)	860-1060	950-1000
Power frequency magnetic field	Temperature (°C)	15-35	23
	Humidity (%RH)	25-75	52
	Barometric pressure (mbar)	860-1060	950-1000
Voltage dips and interruption	Temperature (°C)	15-35	23
	Humidity (%RH)	25-75	51
	Barometric pressure (mbar)	860-1060	950-1000

3. Conducted Emissions(Main Terminals)

3.1. Test Specification

According to EMC Standard : EN 55032

3.2. Test Setup

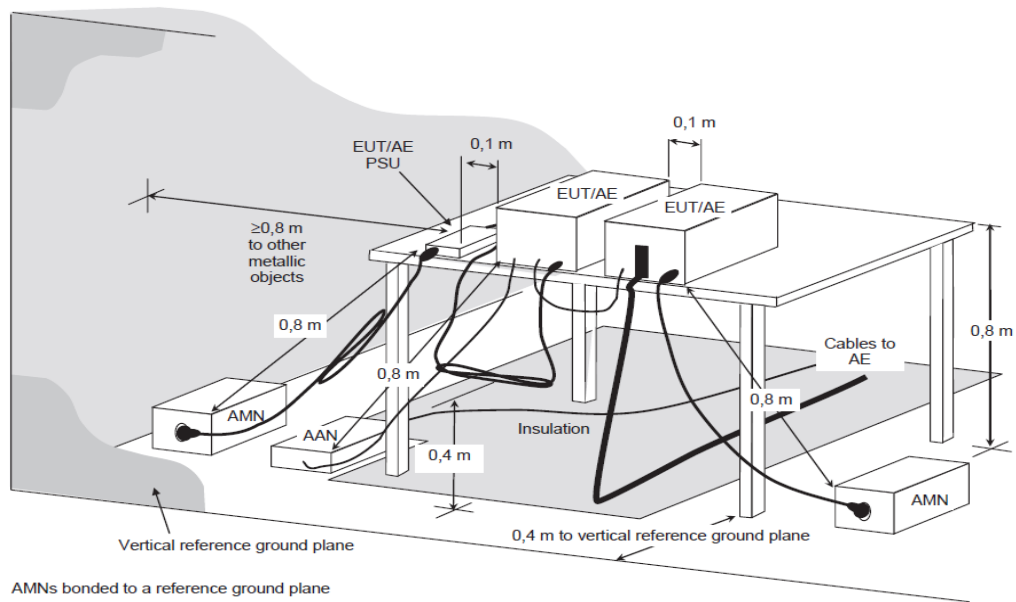

3.3. Limit

AC mains power ports			
Frequency range MHz	Coupling device	Detector type/ Bandwidth	Class B limits dB(µV)
0.15 - 0.5	AMN	Quasi Peak / 9 KHz	66 - 56
0.50 - 5.0			56
0.5 - 30			60
0.15 - 0.5	AMN	Average / 9 KHz	56 - 46
0.50 - 5.0			46
0.5 - 30			50

Both apply across the entire frequency range.

Remarks: In the above table, the tighter limit applies at the band edges.

3.4. Test Procedure

The EUT and simulators are connected to the main power through a line impedance stabilization network (L.I.S.N.). This provides a 50 ohm /50uH coupling impedance for the measuring equipment. The peripheral devices are also connected to the main power through a LISN that provides a 50ohm/50uH coupling impedance with 50ohm termination.

(Please refers to the block diagram of the test setup and photographs.)

Both sides of A.C. line are checked for maximum conducted interference. In order to find the maximum emission, the relative positions of equipment and all of the interface cables must be changed on conducted measurement.

Conducted emissions were invested over the frequency range from 0.15MHz to 30MHz using a receiver bandwidth of 9kHz.

3.5. Deviation from Test Standard

No deviation.

3.6. Test Result

Site : SR2	Time : 2016/02/26 - 15:03
Limit : CISPR_B_00M_QP	Margin : 10
Probe : SR2_LISN(16A)-5_0818 - Line1	Power : AC 230V/50Hz
EUT : Printer	Note : Mode 1: PC Printing (110W)

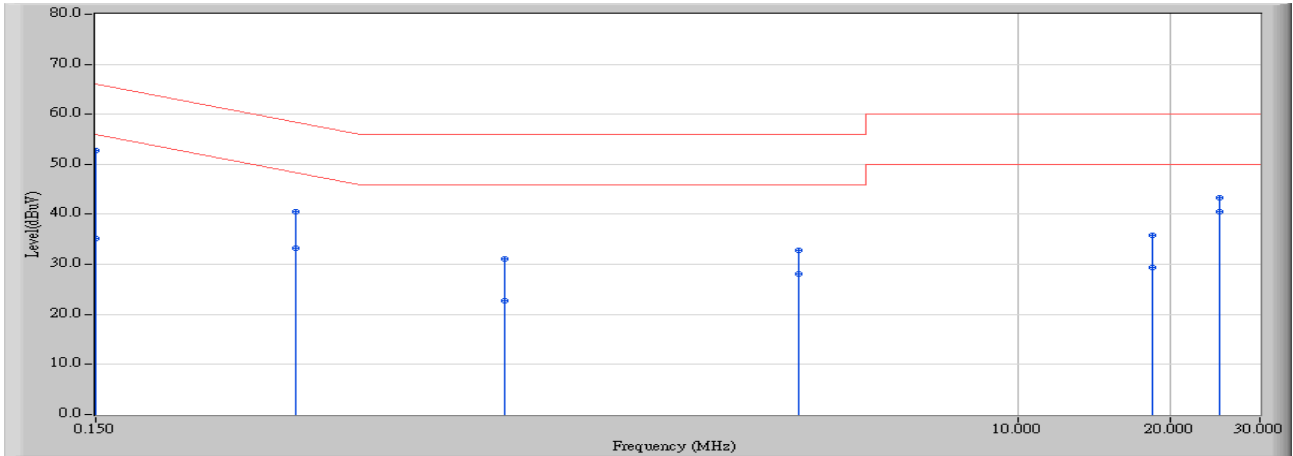

	Frequency (MHz)	Correct Factor (dB)	Reading Level (dBuV)	Measure Level (dBuV)	Margin (dB)	Limit (dBuV)	Detector Type
1	0.150	9.692	25.400	35.092	-20.908	56.000	AVERAGE
2	0.150	9.692	43.100	52.792	-13.208	66.000	QUASPEAK
3	0.372	9.703	30.860	40.563	-17.882	58.445	QUASPEAK
4	0.372	9.703	23.610	33.313	-15.132	48.445	AVERAGE
5	0.966	9.720	21.350	31.070	-24.930	56.000	QUASPEAK
6	0.966	9.720	13.020	22.740	-23.260	46.000	AVERAGE
7	3.673	9.853	22.940	32.793	-23.207	56.000	QUASPEAK
8	3.673	9.853	18.260	28.113	-17.887	46.000	AVERAGE
9	18.396	10.313	25.540	35.853	-24.147	60.000	QUASPEAK
10	18.396	10.313	19.110	29.423	-20.577	50.000	AVERAGE
11	24.905	10.463	32.960	43.423	-16.577	60.000	QUASPEAK
12	* 24.905	10.463	30.070	40.533	-9.467	50.000	AVERAGE

Note:

1. All Reading Levels are Quasi-Peak and average value.
2. " * ", means this data is the worst emission level.
3. Measurement Level = Reading Level + Correct Factor.

Site : SR2	Time : 2016/02/26 - 15:00
Limit : CISPR_B_00M_QP	Margin : 10
Probe : SR2_LISN(16A)-5_0818 - Line2	Power : AC 230V/50Hz
EUT : Printer	Note : Mode 1: PC Printing (110W)

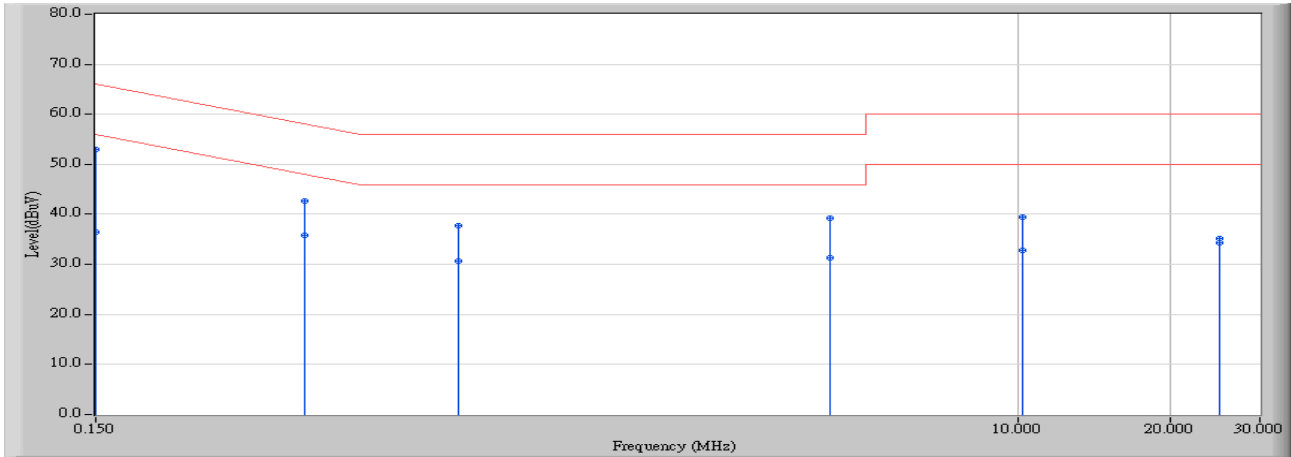

		Frequency (MHz)	Correct Factor (dB)	Reading Level (dBuV)	Measure Level (dBuV)	Margin (dB)	Limit (dBuV)	Detector Type
1		0.150	9.762	43.300	53.062	-12.938	66.000	QUASIPeAK
2		0.150	9.762	26.720	36.482	-19.518	56.000	AVERAGE
3		0.390	9.785	32.970	42.755	-15.319	58.074	QUASIPeAK
4	*	0.390	9.785	26.060	35.845	-12.229	48.074	AVERAGE
5		0.780	9.806	27.890	37.696	-18.304	56.000	QUASIPeAK
6		0.780	9.806	20.820	30.626	-15.374	46.000	AVERAGE
7		4.240	9.956	29.340	39.296	-16.704	56.000	QUASIPeAK
8		4.240	9.956	21.420	31.376	-14.624	46.000	AVERAGE
9		10.205	10.141	29.370	39.511	-20.489	60.000	QUASIPeAK
10		10.205	10.141	22.770	32.911	-17.089	50.000	AVERAGE
11		24.905	10.255	25.000	35.255	-24.745	60.000	QUASIPeAK
12		24.905	10.255	23.970	34.225	-15.775	50.000	AVERAGE

Note:

1. All Reading Levels are Quasi-Peak and average value.
2. " * ", means this data is the worst emission level.
3. Measurement Level = Reading Level + Correct Factor.

Site : SR2	Time : 2016/02/26 - 15:23
Limit : CISPR_B_00M_QP	Margin : 10
Probe : SR2_LISN(16A)-5_0818 - Line1	Power : AC 230V/50Hz
EUT : Printer	Note : Mode 2: LAN Printing (110W)

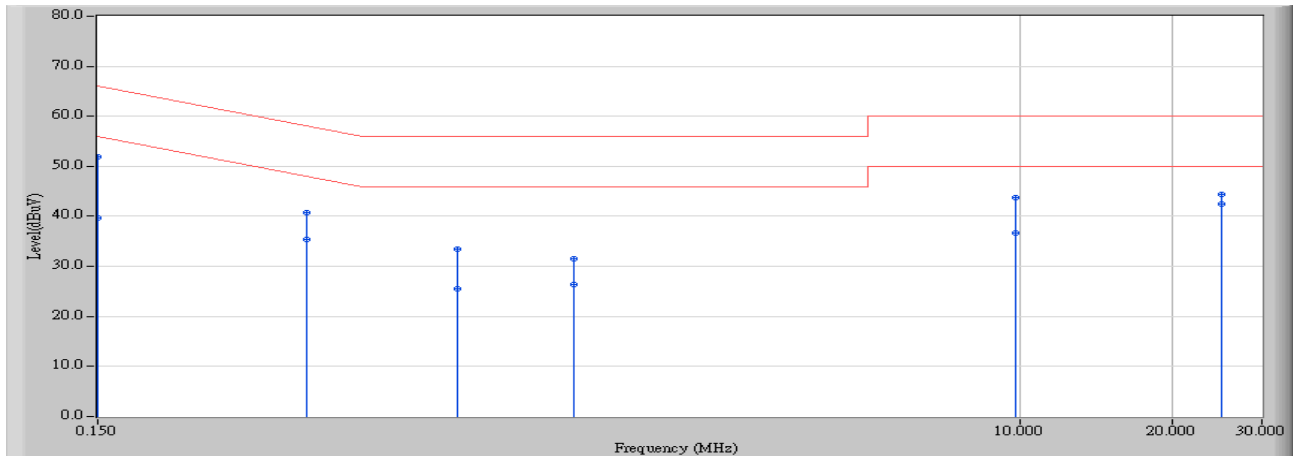

		Frequency (MHz)	Correct Factor (dB)	Reading Level (dBuV)	Measure Level (dBuV)	Margin (dB)	Limit (dBuV)	Detector Type
1		0.150	9.692	29.980	39.672	-16.328	56.000	AVERAGE
2		0.150	9.692	42.300	51.992	-14.008	66.000	QUASIPeAK
3		0.388	9.705	30.960	40.665	-17.453	58.117	QUASIPeAK
4		0.388	9.705	25.620	35.325	-12.793	48.117	AVERAGE
5		0.771	9.720	23.660	33.380	-22.620	56.000	QUASIPeAK
6		0.771	9.720	15.890	25.610	-20.390	46.000	AVERAGE
7		1.314	9.739	21.810	31.549	-24.451	56.000	QUASIPeAK
8		1.314	9.739	16.610	26.349	-19.651	46.000	AVERAGE
9		9.795	10.102	33.560	43.662	-16.338	60.000	QUASIPeAK
10		9.795	10.102	26.660	36.762	-13.238	50.000	AVERAGE
11		24.908	10.463	34.040	44.503	-15.497	60.000	QUASIPeAK
12	*	24.908	10.463	31.950	42.413	-7.587	50.000	AVERAGE

Note:

1. All Reading Levels are Quasi-Peak and average value.
2. " * ", means this data is the worst emission level.
3. Measurement Level = Reading Level + Correct Factor.

Site : SR2	Time : 2016/02/26 - 15:26
Limit : CISPR_B_00M_QP	Margin : 10
Probe : SR2_LISN(16A)-5_0818 - Line2	Power : AC 230V/50Hz
EUT : Printer	Note : Mode 2: LAN Printing (110W)

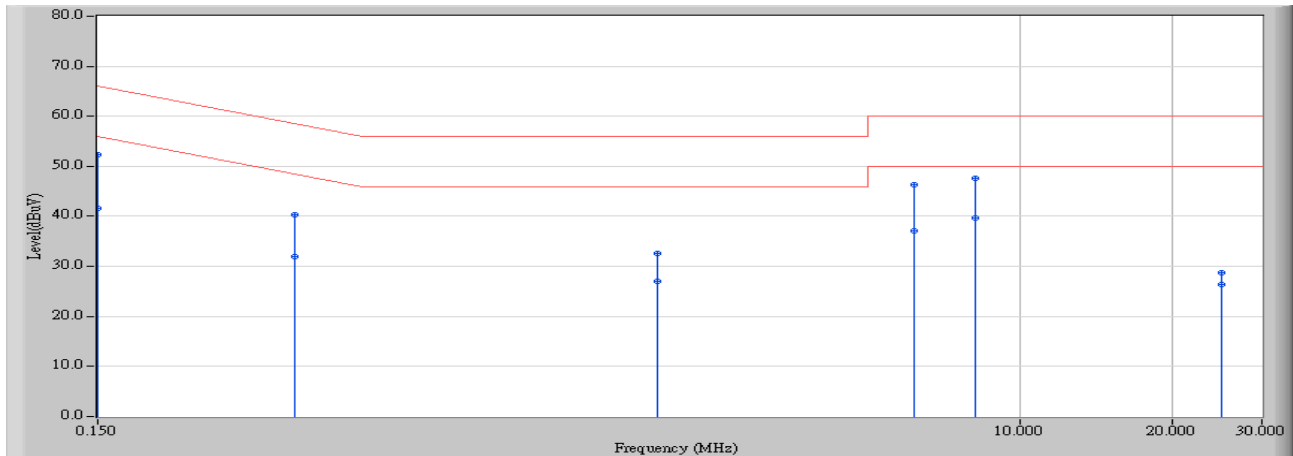

		Frequency (MHz)	Correct Factor (dB)	Reading Level (dBuV)	Measure Level (dBuV)	Margin (dB)	Limit (dBuV)	Detector Type
1		0.150	9.762	42.510	52.272	-13.728	66.000	QUASIPeAK
2		0.150	9.762	31.790	41.552	-14.448	56.000	AVERAGE
3		0.367	9.783	30.570	40.353	-18.205	58.557	QUASIPeAK
4		0.367	9.783	22.120	31.903	-16.655	48.557	AVERAGE
5		1.920	9.865	22.810	32.675	-23.325	56.000	QUASIPeAK
6		1.920	9.865	17.140	27.005	-18.995	46.000	AVERAGE
7		6.158	10.021	36.230	46.251	-13.749	60.000	QUASIPeAK
8		6.158	10.021	27.050	37.071	-12.929	50.000	AVERAGE
9		8.142	10.083	37.570	47.652	-12.348	60.000	QUASIPeAK
10	*	8.142	10.083	29.560	39.642	-10.358	50.000	AVERAGE
11		24.902	10.255	18.420	28.675	-31.325	60.000	QUASIPeAK
12		24.902	10.255	16.140	26.395	-23.605	50.000	AVERAGE

Note:

1. All Reading Levels are Quasi-Peak and average value.
2. " * ", means this data is the worst emission level.
3. Measurement Level = Reading Level + Correct Factor.

Site : SR2	Time : 2016/02/26 - 14:23
Limit : CISPR_B_00M_QP	Margin : 10
Probe : SR2_LISN(16A)-5_0818 - Line1	Power : AC 230V/50Hz
EUT : Printer	Note : Mode 3: Documents Printing (110W)

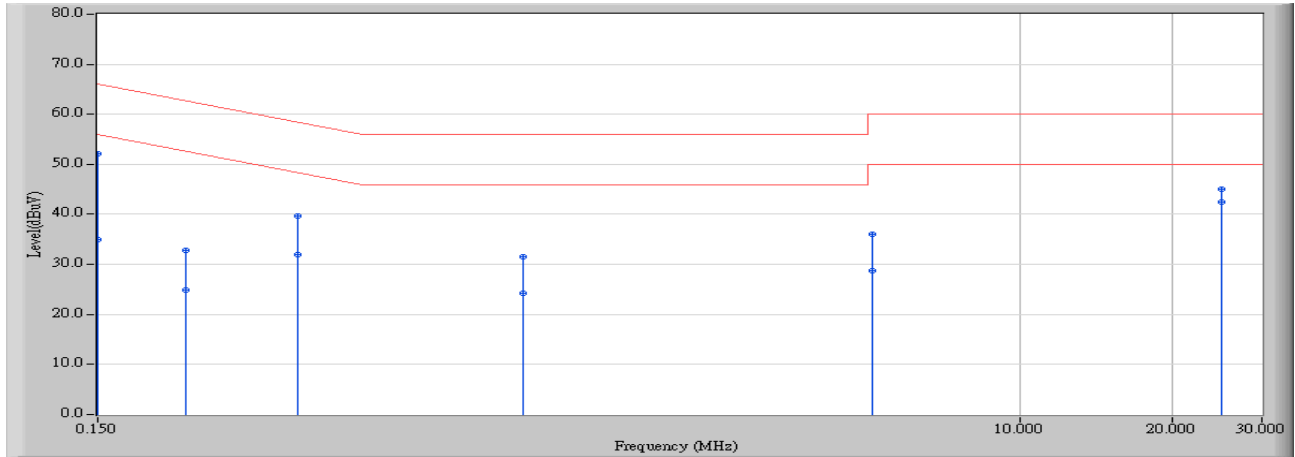

		Frequency (MHz)	Correct Factor (dB)	Reading Level (dBuV)	Measure Level (dBuV)	Margin (dB)	Limit (dBuV)	Detector Type
1		0.150	9.692	42.500	52.192	-13.808	66.000	QUASIPeAK
2		0.150	9.692	25.320	35.012	-20.988	56.000	AVERAGE
3		0.224	9.689	23.140	32.829	-29.832	62.661	QUASIPeAK
4		0.224	9.689	15.170	24.859	-27.802	52.661	AVERAGE
5		0.372	9.704	30.040	39.743	-18.719	58.462	QUASIPeAK
6		0.372	9.704	22.170	31.873	-16.589	48.462	AVERAGE
7		1.037	9.722	21.900	31.622	-24.378	56.000	QUASIPeAK
8		1.037	9.722	14.500	24.222	-21.778	46.000	AVERAGE
9		5.088	9.917	26.020	35.937	-24.063	60.000	QUASIPeAK
10		5.088	9.917	18.760	28.677	-21.323	50.000	AVERAGE
11		24.908	10.463	34.500	44.963	-15.037	60.000	QUASIPeAK
12	*	24.908	10.463	32.020	42.483	-7.517	50.000	AVERAGE

Note:

1. All Reading Levels are Quasi-Peak and average value.
2. " * ", means this data is the worst emission level.
3. Measurement Level = Reading Level + Correct Factor.

Site : SR2	Time : 2016/02/26 - 14:29
Limit : CISPR_B_00M_QP	Margin : 10
Probe : SR2_LISN(16A)-5_0818 - Line2	Power : AC 230V/50Hz
EUT : Printer	Note : Mode 3: Documents Printing (110W)

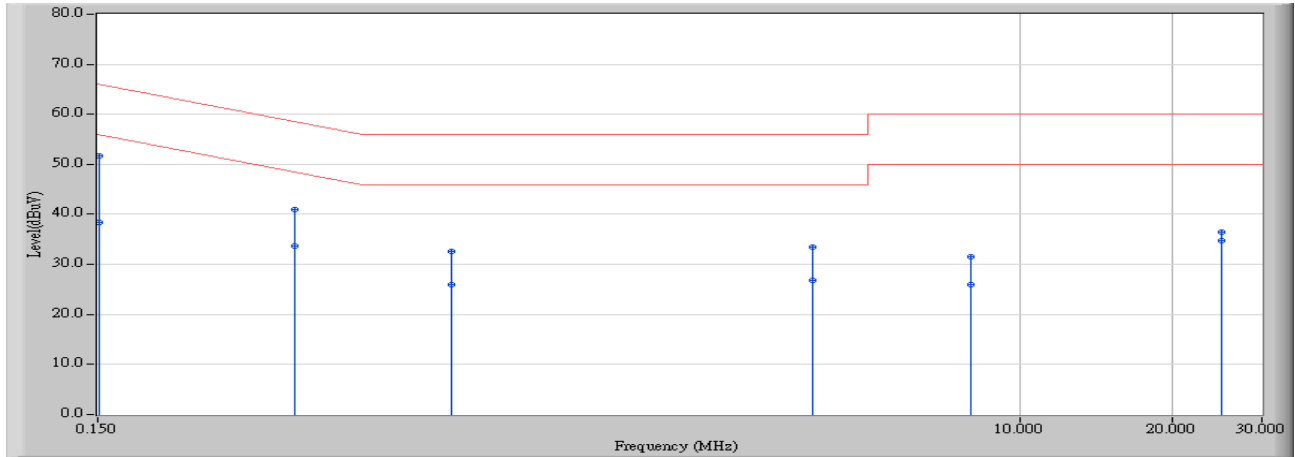

		Frequency (MHz)	Correct Factor (dB)	Reading Level (dBuV)	Measure Level (dBuV)	Margin (dB)	Limit (dBuV)	Detector Type
1		0.151	9.762	28.550	38.312	-17.636	55.948	AVERAGE
2	*	0.151	9.762	41.900	51.662	-14.283	65.945	QUASIPeAK
3		0.368	9.783	31.130	40.913	-17.623	58.536	QUASIPeAK
4		0.368	9.783	23.990	33.773	-14.763	48.536	AVERAGE
5		0.751	9.806	22.790	32.596	-23.404	56.000	QUASIPeAK
6		0.751	9.806	16.170	25.976	-20.024	46.000	AVERAGE
7		3.884	9.942	23.620	33.562	-22.438	56.000	QUASIPeAK
8		3.884	9.942	16.790	26.732	-19.268	46.000	AVERAGE
9		7.974	10.077	21.470	31.547	-28.453	60.000	QUASIPeAK
10		7.974	10.077	15.780	25.857	-24.143	50.000	AVERAGE
11		24.905	10.255	26.160	36.415	-23.585	60.000	QUASIPeAK
12		24.905	10.255	24.440	34.695	-15.305	50.000	AVERAGE

Note:

1. All Reading Levels are Quasi-Peak and average value.
2. " * ", means this data is the worst emission level.
3. Measurement Level = Reading Level + Correct Factor.

Site : SR2	Time : 2016/04/08 - 13:43
Limit : CISPR_B_00M_QP	Margin : 10
Probe : SR2_LISN(16A)-5_0818 - Line1	Power : AC 230V/50Hz
EUT : Printer	Note : Mode 4: WiFi Printing (110W)

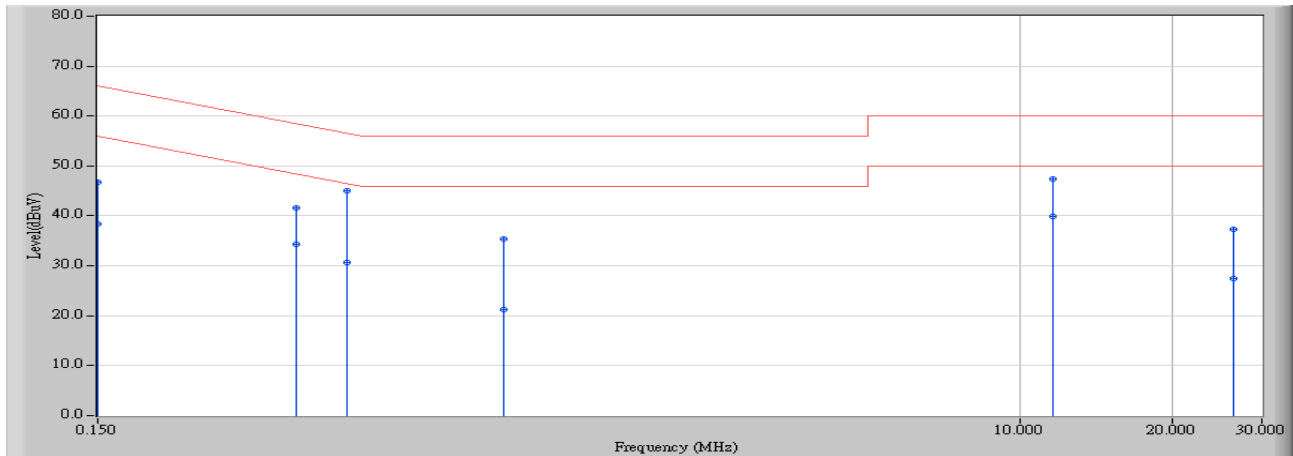

		Frequency (MHz)	Correct Factor (dB)	Reading Level (dBuV)	Measure Level (dBuV)	Margin (dB)	Limit (dBuV)	Detector Type
1		0.150	9.692	37.090	46.782	-19.218	66.000	QUASIPeAK
2		0.150	9.692	28.700	38.392	-27.608	66.000	AVERAGE
3		0.371	9.703	31.880	41.583	-16.896	58.479	QUASIPeAK
4		0.371	9.703	24.620	34.323	-24.156	58.479	AVERAGE
5	*	0.466	9.715	35.340	45.055	-11.530	56.585	QUASIPeAK
6		0.466	9.715	21.010	30.725	-25.860	56.585	AVERAGE
7		0.951	9.720	25.700	35.420	-20.580	56.000	QUASIPeAK
8		0.951	9.720	11.460	21.180	-34.820	56.000	AVERAGE
9		11.576	10.143	37.300	47.443	-12.557	60.000	QUASIPeAK
10		11.576	10.143	29.810	39.953	-20.047	60.000	AVERAGE
11		26.283	10.489	26.830	37.319	-22.681	60.000	QUASIPeAK
12		26.283	10.489	16.900	27.389	-32.611	60.000	AVERAGE

Note:

1. All Reading Levels are Quasi-Peak and average value.
2. " * ", means this data is the worst emission level.
3. Measurement Level = Reading Level + Correct Factor.

Site : SR2	Time : 2016/04/08 - 13:55
Limit : CISPR_B_00M_QP	Margin : 10
Probe : SR2_LISN(16A)-5_0818 - Line2	Power : AC 230V/50Hz
EUT : Printer	Note : Mode 4: WiFi Printing (110W)

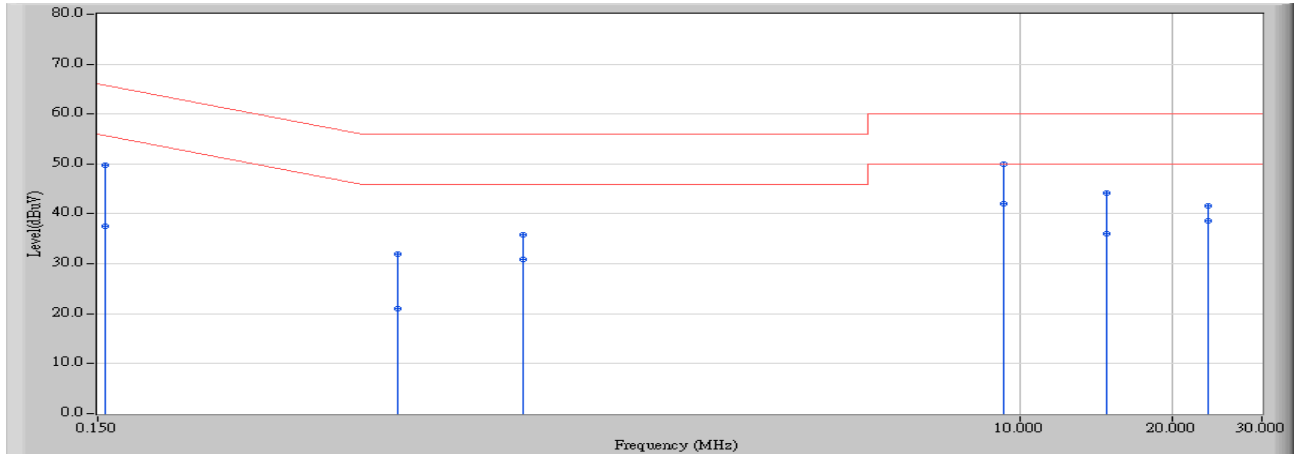

		Frequency (MHz)	Correct Factor (dB)	Reading Level (dBuV)	Measure Level (dBuV)	Margin (dB)	Limit (dBuV)	Detector Type
1		0.155	9.762	39.890	49.652	-16.076	65.728	QUASPEAK
2		0.155	9.762	27.830	37.592	-18.136	55.728	AVERAGE
3		0.588	9.803	22.160	31.963	-24.037	56.000	QUASPEAK
4		0.588	9.803	11.310	21.113	-24.887	46.000	AVERAGE
5		1.037	9.812	25.990	35.802	-20.198	56.000	QUASPEAK
6		1.037	9.812	20.980	30.792	-15.208	46.000	AVERAGE
7		9.287	10.117	39.950	50.068	-9.932	60.000	QUASPEAK
8	*	9.287	10.117	31.850	41.968	-8.032	50.000	AVERAGE
9		14.779	10.164	33.940	44.104	-15.896	60.000	QUASPEAK
10		14.779	10.164	25.770	35.934	-14.066	50.000	AVERAGE
11		23.568	10.248	31.280	41.528	-18.472	60.000	QUASPEAK
12		23.568	10.248	28.460	38.708	-11.292	50.000	AVERAGE

Note:

1. All Reading Levels are Quasi-Peak and average value.
2. " * ", means this data is the worst emission level.
3. Measurement Level = Reading Level + Correct Factor.

Site : SR3	Time : 2016/02/18 - 17:37
Limit : CISPR_B_00M_QP	Margin : 10
Probe : SR3_LISN(16A)-5_0728 - Line2	Power : AC 230V/50Hz
EUT : Printer	Note : Mode 5: PC Printing (72W)

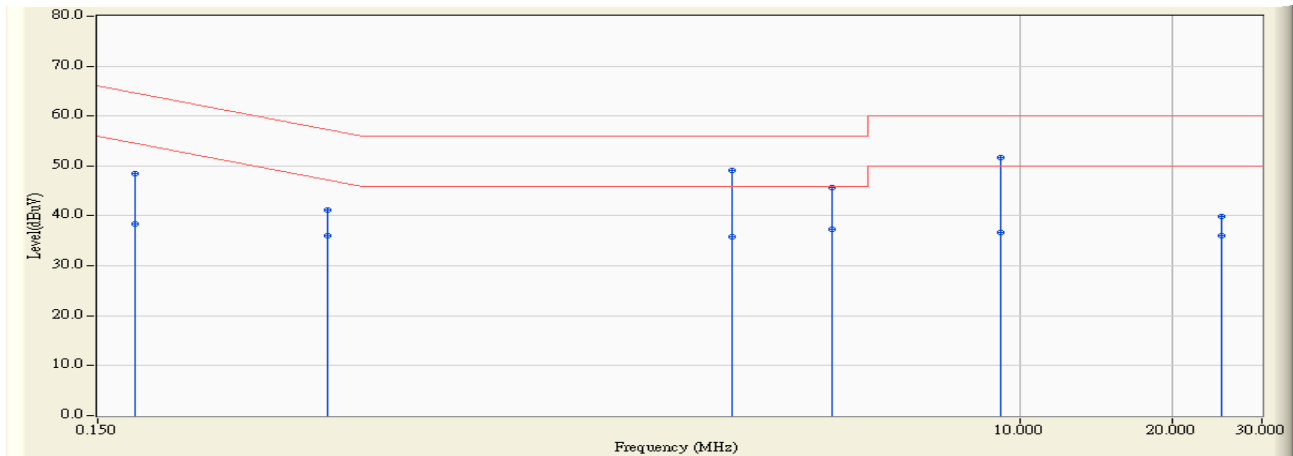

	Frequency (MHz)	Correct Factor (dB)	Reading Level (dBuV)	Measure Level (dBuV)	Margin (dB)	Limit (dBuV)	Detector Type
1	0.177	9.658	38.760	48.418	-16.191	64.609	QUASIPeAK
2	0.177	9.658	28.710	38.368	-16.241	54.609	AVERAGE
3	0.427	9.789	31.370	41.159	-16.145	57.304	QUASIPeAK
4	0.427	9.789	26.240	36.029	-11.275	47.304	AVERAGE
5	*	2.697	39.160	49.137	-6.863	56.000	QUASIPeAK
6	2.697	9.977	25.850	35.827	-10.173	46.000	AVERAGE
7	4.236	10.043	35.570	45.613	-10.387	56.000	QUASIPeAK
8	4.236	10.043	27.280	37.323	-8.677	46.000	AVERAGE
9	9.134	10.138	41.470	51.608	-8.392	60.000	QUASIPeAK
10	9.134	10.138	26.480	36.618	-13.382	50.000	AVERAGE
11	24.907	10.319	29.620	39.939	-20.061	60.000	QUASIPeAK
12	24.907	10.319	25.620	35.939	-14.061	50.000	AVERAGE

Note:

1. All Reading Levels are Quasi-Peak and average value.
2. " * ", means this data is the worst emission level.
3. Measurement Level = Reading Level + Correct Factor.

Site : SR3	Time : 2016/02/18 - 17:40
Limit : CISPR_B_00M_QP	Margin : 10
Probe : SR3_LISN(16A)-5_0728 - Line1	Power : AC 230V/50Hz
EUT : Printer	Note : Mode 5: PC Printing (72W)

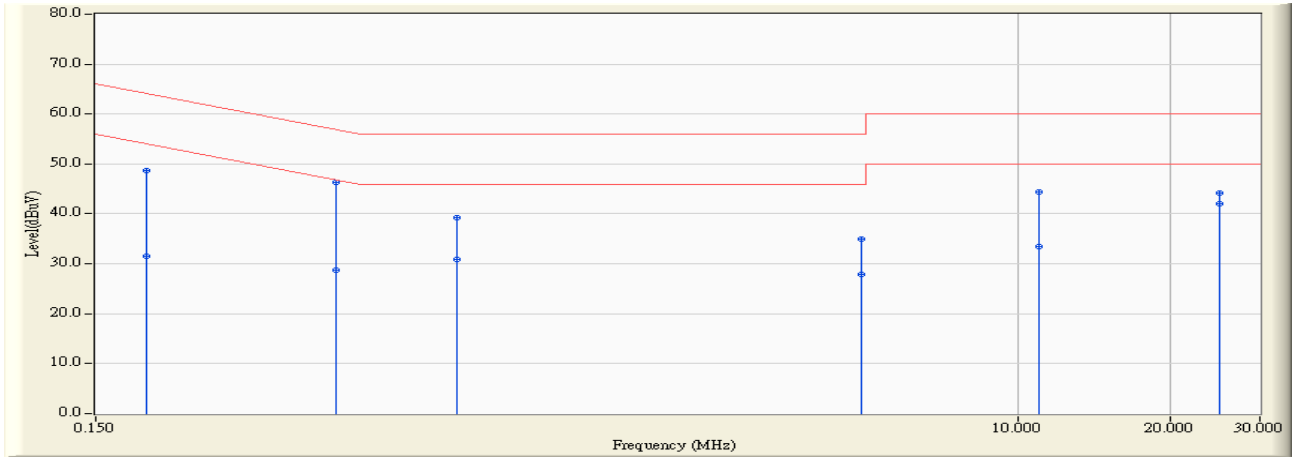

		Frequency (MHz)	Correct Factor (dB)	Reading Level (dBuV)	Measure Level (dBuV)	Margin (dB)	Limit (dBuV)	Detector Type
1		0.189	9.662	39.100	48.762	-15.315	64.078	QUASIPeAK
2		0.189	9.662	21.860	31.522	-22.555	54.078	AVERAGE
3		0.447	9.812	36.560	46.372	-10.567	56.939	QUASIPeAK
4		0.447	9.812	18.930	28.742	-18.197	46.939	AVERAGE
5		0.775	9.895	29.360	39.255	-16.745	56.000	QUASIPeAK
6		0.775	9.895	20.930	30.825	-15.175	46.000	AVERAGE
7		4.888	10.077	24.830	34.907	-21.093	56.000	QUASIPeAK
8		4.888	10.077	17.770	27.847	-18.153	46.000	AVERAGE
9		11.002	10.122	34.330	44.452	-15.548	60.000	QUASIPeAK
10		11.002	10.122	23.350	33.472	-16.528	50.000	AVERAGE
11		24.908	10.120	34.120	44.240	-15.760	60.000	QUASIPeAK
12	*	24.908	10.120	31.860	41.980	-8.020	50.000	AVERAGE

Note:

1. All Reading Levels are Quasi-Peak and average value.
2. " * ", means this data is the worst emission level.
3. Measurement Level = Reading Level + Correct Factor.

Site : SR3	Time : 2016/03/14 - 16:20
Limit : CISPR_B_00M_QP	Margin : 10
Probe : SR3_LISN(16A)-5_0728 - Line1	Power : AC 230V/50Hz
EUT : Printer	Note : Mode 6: LAN Printing (72W)

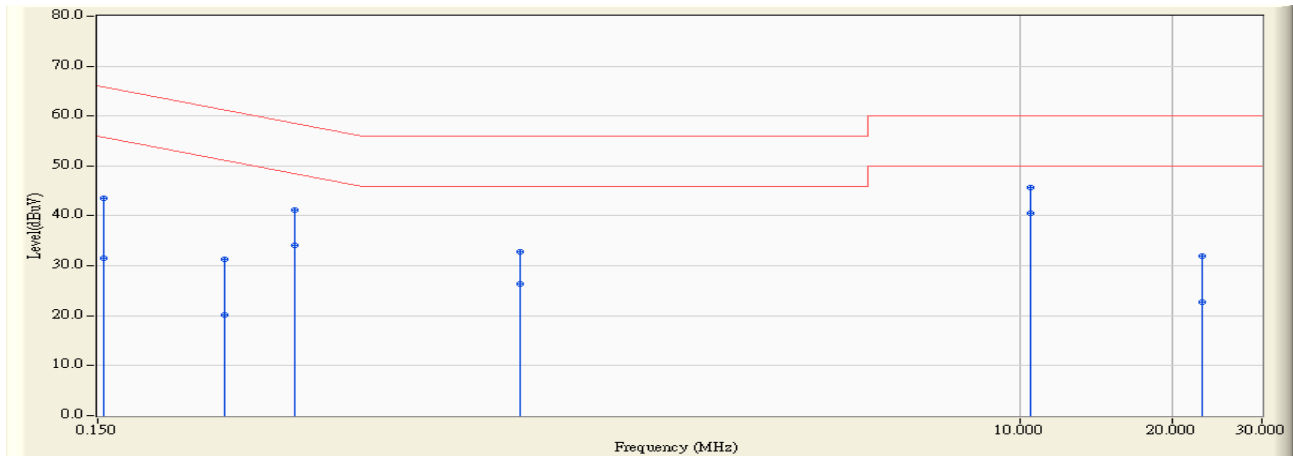

		Frequency (MHz)	Correct Factor (dB)	Reading Level (dBuV)	Measure Level (dBuV)	Margin (dB)	Limit (dBuV)	Detector Type
1		0.154	9.657	33.980	43.638	-22.149	65.786	QUASIPeAK
2		0.154	9.657	21.840	31.498	-24.289	55.786	AVERAGE
3		0.267	9.706	21.530	31.236	-29.969	61.205	QUASIPeAK
4		0.267	9.706	10.540	20.246	-30.959	51.205	AVERAGE
5		0.369	9.770	31.350	41.120	-17.409	58.529	QUASIPeAK
6		0.369	9.770	24.310	34.080	-14.449	48.529	AVERAGE
7		1.029	9.940	22.840	32.780	-23.220	56.000	QUASIPeAK
8		1.029	9.940	16.350	26.290	-19.710	46.000	AVERAGE
9		10.502	10.121	35.470	45.591	-14.409	60.000	QUASIPeAK
10	*	10.502	10.121	30.360	40.481	-9.519	50.000	AVERAGE
11		22.830	10.120	21.870	31.990	-28.010	60.000	QUASIPeAK
12		22.830	10.120	12.570	22.690	-27.310	50.000	AVERAGE

Note:

1. All Reading Levels are Quasi-Peak and average value.
2. " * ", means this data is the worst emission level.
3. Measurement Level = Reading Level + Correct Factor.

Site : SR3	Time : 2016/03/14 - 16:19
Limit : CISPR_B_00M_QP	Margin : 10
Probe : SR3_LISN(16A)-5_0728 - Line2	Power : AC 230V/50Hz
EUT : Printer	Note : Mode 6: LAN Printing (72W)

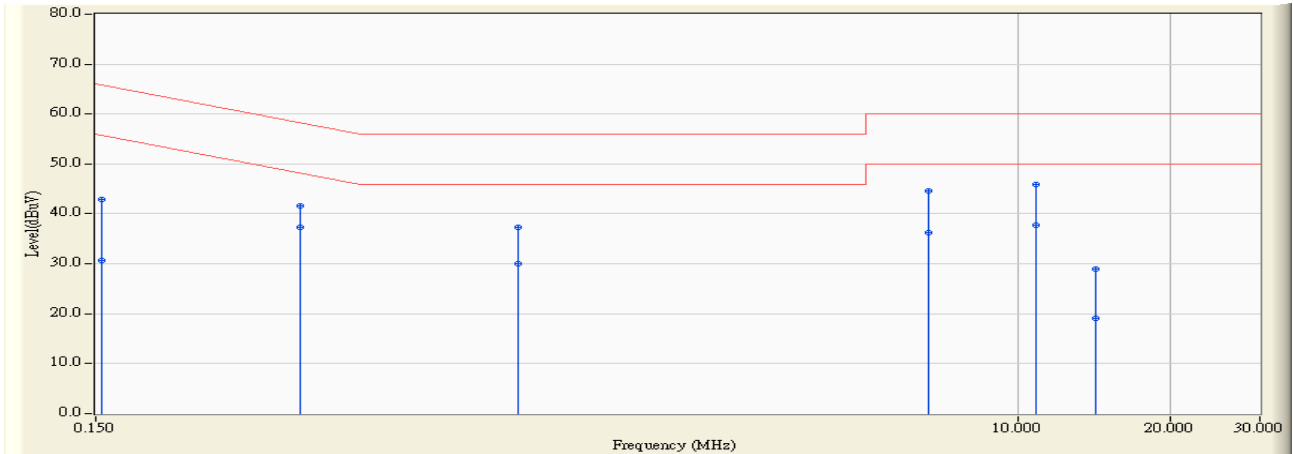

	Frequency (MHz)	Correct Factor (dB)	Reading Level (dBuV)	Measure Level (dBuV)	Margin (dB)	Limit (dBuV)	Detector Type
1	0.154	9.653	33.300	42.953	-22.833	65.786	QUASIPeAK
2	0.154	9.653	21.110	30.763	-25.023	55.786	AVERAGE
3	0.380	9.765	31.770	41.535	-16.734	58.269	QUASIPeAK
4	* 0.380	9.765	27.550	37.315	-10.954	48.269	AVERAGE
5	1.025	9.940	27.330	37.270	-18.730	56.000	QUASIPeAK
6	1.025	9.940	20.150	30.090	-15.910	46.000	AVERAGE
7	6.630	10.105	34.450	44.555	-15.445	60.000	QUASIPeAK
8	6.630	10.105	26.040	36.145	-13.855	50.000	AVERAGE
9	10.841	10.160	35.780	45.940	-14.060	60.000	QUASIPeAK
10	10.841	10.160	27.660	37.820	-12.180	50.000	AVERAGE
11	14.224	10.201	18.730	28.931	-31.069	60.000	QUASIPeAK
12	14.224	10.201	8.890	19.091	-30.909	50.000	AVERAGE

Note:

1. All Reading Levels are Quasi-Peak and average value.
2. " * ", means this data is the worst emission level.
3. Measurement Level = Reading Level + Correct Factor.

Site : SR3	Time : 2016/03/14 - 16:16
Limit : CISPR_B_00M_QP	Margin : 10
Probe : SR3_LISN(16A)-5_0728 - Line1	Power : AC 230V/50Hz
EUT : Printer	Note : Mode 7: Documents Printing (72W)

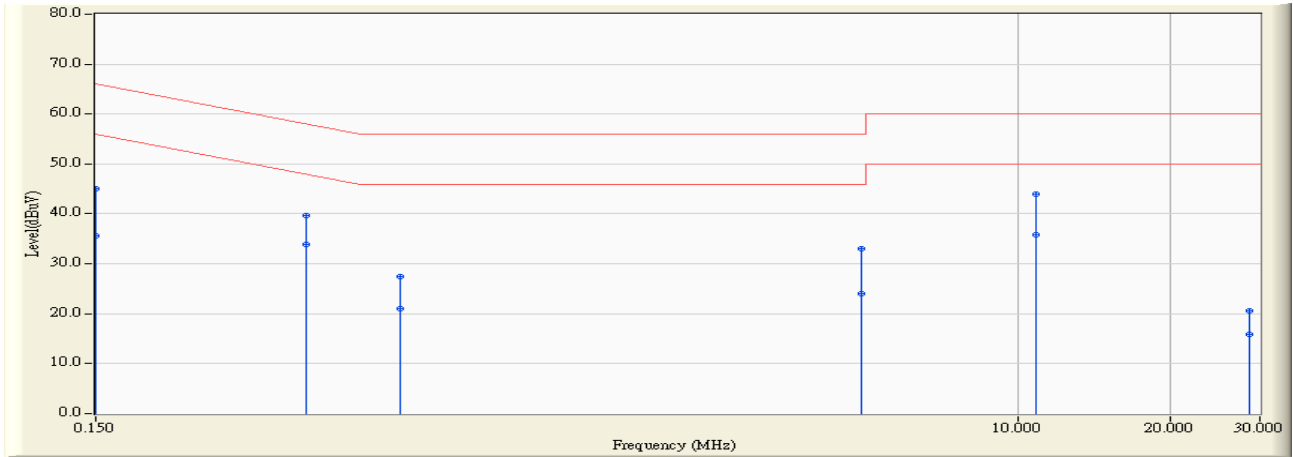

	Frequency (MHz)	Correct Factor (dB)	Reading Level (dBuV)	Measure Level (dBuV)	Margin (dB)	Limit (dBuV)	Detector Type
1	0.150	9.657	35.310	44.967	-21.033	66.000	QUASIPeAK
2	0.150	9.657	25.940	35.597	-20.403	56.000	AVERAGE
3	0.390	9.777	29.960	39.737	-18.327	58.064	QUASIPeAK
4	* 0.390	9.777	24.070	33.847	-14.217	48.064	AVERAGE
5	0.600	9.860	17.690	27.550	-28.450	56.000	QUASIPeAK
6	0.600	9.860	11.080	20.940	-25.060	46.000	AVERAGE
7	4.900	10.078	22.860	32.938	-23.062	56.000	QUASIPeAK
8	4.900	10.078	13.890	23.968	-22.032	46.000	AVERAGE
9	10.806	10.122	33.940	44.062	-15.938	60.000	QUASIPeAK
10	10.806	10.122	25.630	35.752	-14.248	50.000	AVERAGE
11	28.564	10.091	10.540	20.631	-39.369	60.000	QUASIPeAK
12	28.564	10.091	5.750	15.841	-34.159	50.000	AVERAGE

Note:

1. All Reading Levels are Quasi-Peak and average value.
2. " * ", means this data is the worst emission level.
3. Measurement Level = Reading Level + Correct Factor.

Site : SR3	Time : 2016/03/14 - 16:18
Limit : CISPR_B_00M_QP	Margin : 10
Probe : SR3_LISN(16A)-5_0728 - Line2	Power : AC 230V/50Hz
EUT : Printer	Note : Mode 7: Documents Printing (72W)

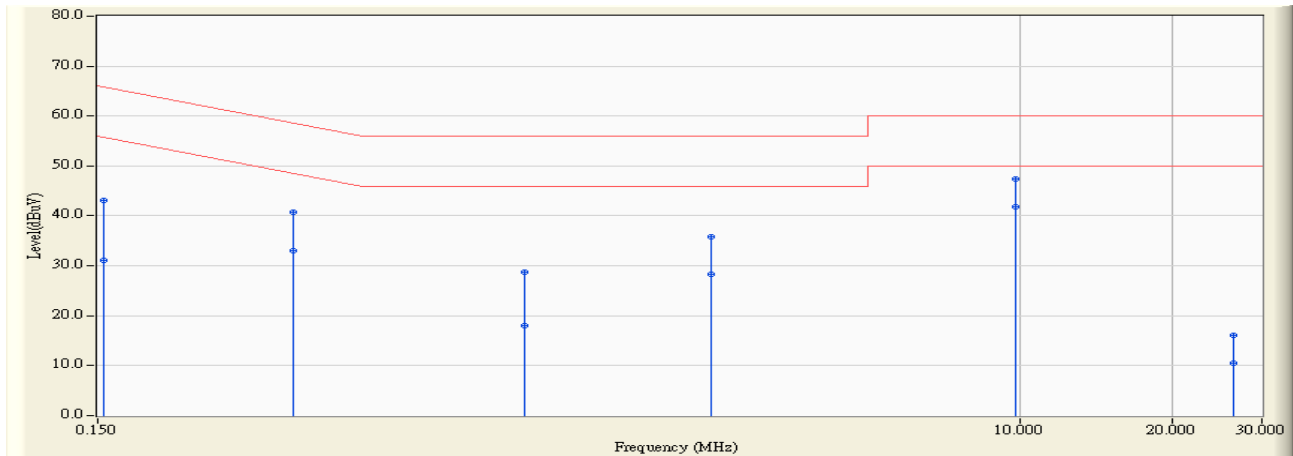

		Frequency (MHz)	Correct Factor (dB)	Reading Level (dBuV)	Measure Level (dBuV)	Margin (dB)	Limit (dBuV)	Detector Type
1		0.154	9.653	33.360	43.013	-22.773	65.786	QUASIPeAK
2		0.154	9.653	21.420	31.073	-24.713	55.786	AVERAGE
3		0.365	9.759	30.990	40.749	-17.868	58.617	QUASIPeAK
4		0.365	9.759	23.310	33.069	-15.548	48.617	AVERAGE
5		1.048	9.940	18.700	28.640	-27.360	56.000	QUASIPeAK
6		1.048	9.940	8.130	18.070	-27.930	46.000	AVERAGE
7		2.439	9.964	25.750	35.715	-20.285	56.000	QUASIPeAK
8		2.439	9.964	18.250	28.215	-17.785	46.000	AVERAGE
9		9.810	10.147	37.300	47.447	-12.553	60.000	QUASIPeAK
10	*	9.810	10.147	31.580	41.727	-8.273	50.000	AVERAGE
11		26.435	10.337	5.780	16.117	-43.883	60.000	QUASIPeAK
12		26.435	10.337	0.150	10.487	-39.513	50.000	AVERAGE

Note:

1. All Reading Levels are Quasi-Peak and average value.
2. " * ", means this data is the worst emission level.
3. Measurement Level = Reading Level + Correct Factor.

Site : SR2	Time : 2016/04/08 - 13:14
Limit : CISPR_B_00M_QP	Margin : 10
Probe : SR2_LISN(16A)-5_0818 - Line1	Power : AC 230V/50Hz
EUT : Printer	Note : Mode 8: WiFi Printing (72W)

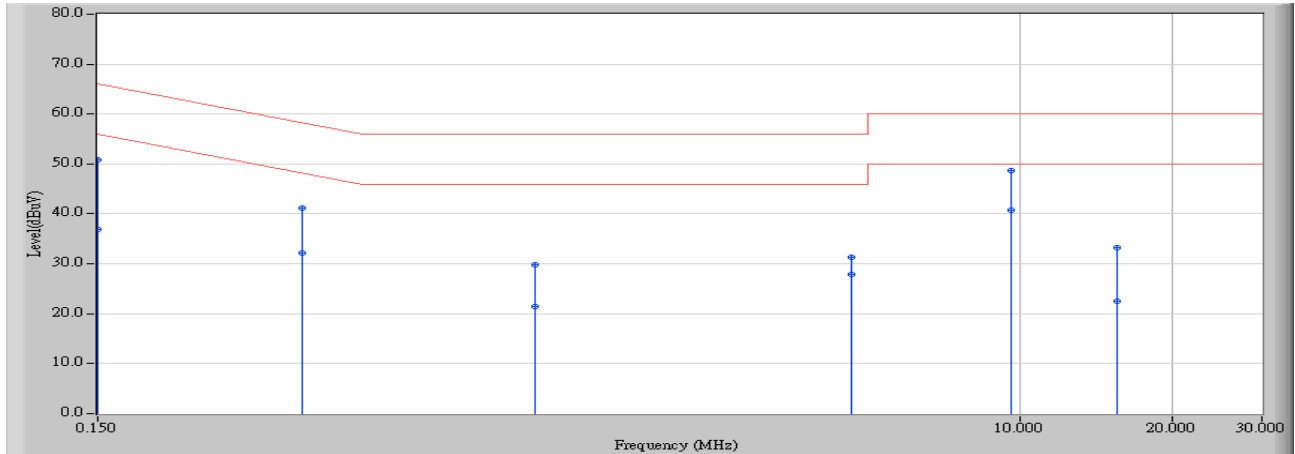

		Frequency (MHz)	Correct Factor (dB)	Reading Level (dBuV)	Measure Level (dBuV)	Margin (dB)	Limit (dBuV)	Detector Type
1		0.150	9.692	41.140	50.832	-15.168	66.000	QUASIPeAK
2		0.150	9.692	27.240	36.932	-19.068	56.000	AVERAGE
3		0.380	9.704	31.420	41.124	-17.145	58.269	QUASIPeAK
4		0.380	9.704	22.550	32.254	-16.015	48.269	AVERAGE
5		1.099	9.726	20.150	29.876	-26.124	56.000	QUASIPeAK
6		1.099	9.726	11.710	21.436	-24.564	46.000	AVERAGE
7		4.627	9.896	21.410	31.306	-24.694	56.000	QUASIPeAK
8		4.627	9.896	17.890	27.786	-18.214	46.000	AVERAGE
9		9.599	10.095	38.550	48.644	-11.356	60.000	QUASIPeAK
10	*	9.599	10.095	30.640	40.734	-9.266	50.000	AVERAGE
11		15.470	10.229	22.920	33.149	-26.851	60.000	QUASIPeAK
12		15.470	10.229	12.370	22.599	-27.401	50.000	AVERAGE

Note:

1. All Reading Levels are Quasi-Peak and average value.
2. " * ", means this data is the worst emission level.
3. Measurement Level = Reading Level + Correct Factor.

Site : SR2	Time : 2016/04/08 - 13:16
Limit : CISPR_B_00M_QP	Margin : 10
Probe : SR2_LISN(16A)-5_0818 - Line2	Power : AC 230V/50Hz
EUT : Printer	Note : Mode 8: WiFi Printing (72W)

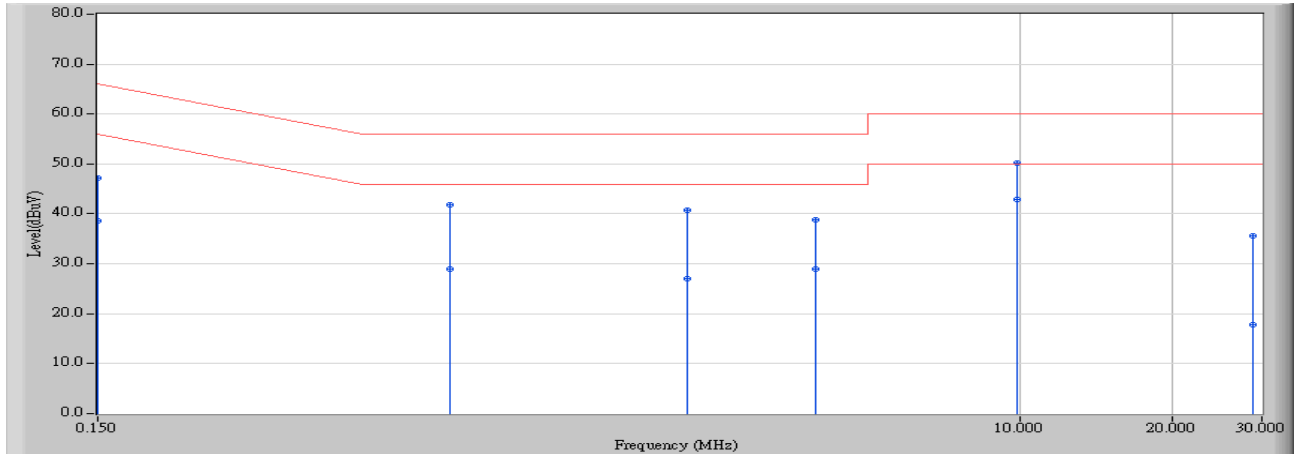

		Frequency (MHz)	Correct Factor (dB)	Reading Level (dBuV)	Measure Level (dBuV)	Margin (dB)	Limit (dBuV)	Detector Type
1		0.150	9.762	37.400	47.162	-18.838	66.000	QUASPEAK
2		0.150	9.762	28.900	38.662	-17.338	56.000	AVERAGE
3		0.744	9.806	31.970	41.776	-14.224	56.000	QUASPEAK
4		0.744	9.806	19.050	28.856	-17.144	46.000	AVERAGE
5		2.197	9.878	30.840	40.718	-15.282	56.000	QUASPEAK
6		2.197	9.878	17.120	26.998	-19.002	46.000	AVERAGE
7		3.939	9.945	28.790	38.734	-17.266	56.000	QUASPEAK
8		3.939	9.945	18.970	28.914	-17.086	46.000	AVERAGE
9		9.853	10.135	39.970	50.105	-9.895	60.000	QUASPEAK
10	*	9.853	10.135	32.770	42.905	-7.095	50.000	AVERAGE
11		28.873	10.266	25.420	35.687	-24.313	60.000	QUASPEAK
12		28.873	10.266	7.530	17.797	-32.203	50.000	AVERAGE

Note:

1. All Reading Levels are Quasi-Peak and average value.
2. " * ", means this data is the worst emission level.
3. Measurement Level = Reading Level + Correct Factor.

3.7. Test Photograph

Test Mode : Mode 1: PC Printing (110W)

Description : Front View of Conducted Emissions Test Setup



Test Mode : Mode 1: PC Printing (110W)

Description : Back View of Conducted Emissions Test Setup

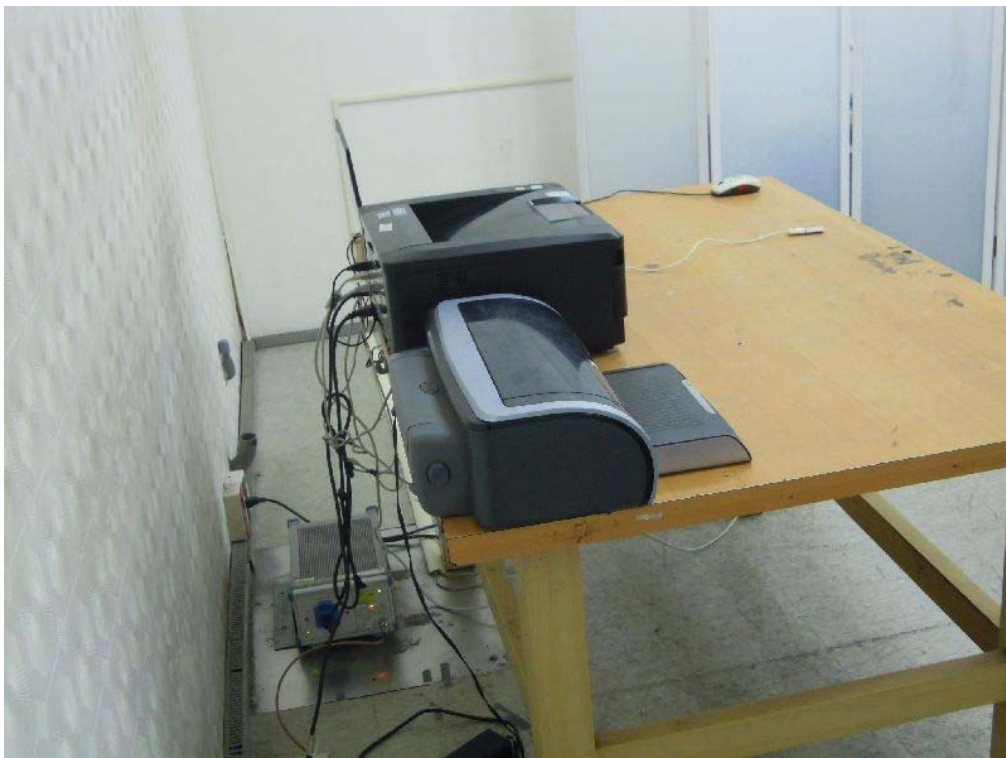

Test Mode : Mode 2: LAN Printing (110W)

Description : Front View of Conducted Emissions Test Setup



Test Mode : Mode 2: LAN Printing (110W)

Description : Back View of Conducted Emissions Test Setup



Test Mode : Mode 3: Document Printing (110W)

Description : Front View of Conducted Emissions Test Setup



Test Mode : Mode 3: Document Printing (110W)

Description : Back View of Conducted Emissions Test Setup



Test Mode : Mode 4: WiFi Printing (110W)

Description : Front View of Conducted Emissions Test Setup



Test Mode : Mode 4: WiFi Printing (110W)

Description : Back View of Conducted Emissions Test Setup



Test Mode : Mode 5: PC Printing (72W)

Description : Front View of Conducted Emissions Test Setup



Test Mode : Mode 5: PC Printing (72W)

Description : Back View of Conducted Emissions Test Setup



Test Mode : Mode 6: LAN Printing (72W)

Description : Front View of Conducted Emissions Test Setup



Test Mode : Mode 6: LAN Printing (72W)

Description : Back View of Conducted Emissions Test Setup



Test Mode : Mode 7: Document Printing (72W)

Description : Front View of Conducted Emissions Test Setup



Test Mode : Mode 7: Document Printing (72W)

Description : Back View of Conducted Emissions Test Setup



Test Mode : Mode 8: WiFi Printing (72W)

Description : Front View of Conducted Emissions Test Setup



Test Mode : Mode 8: WiFi Printing (72W)

Description : Back View of Conducted Emissions Test Setup

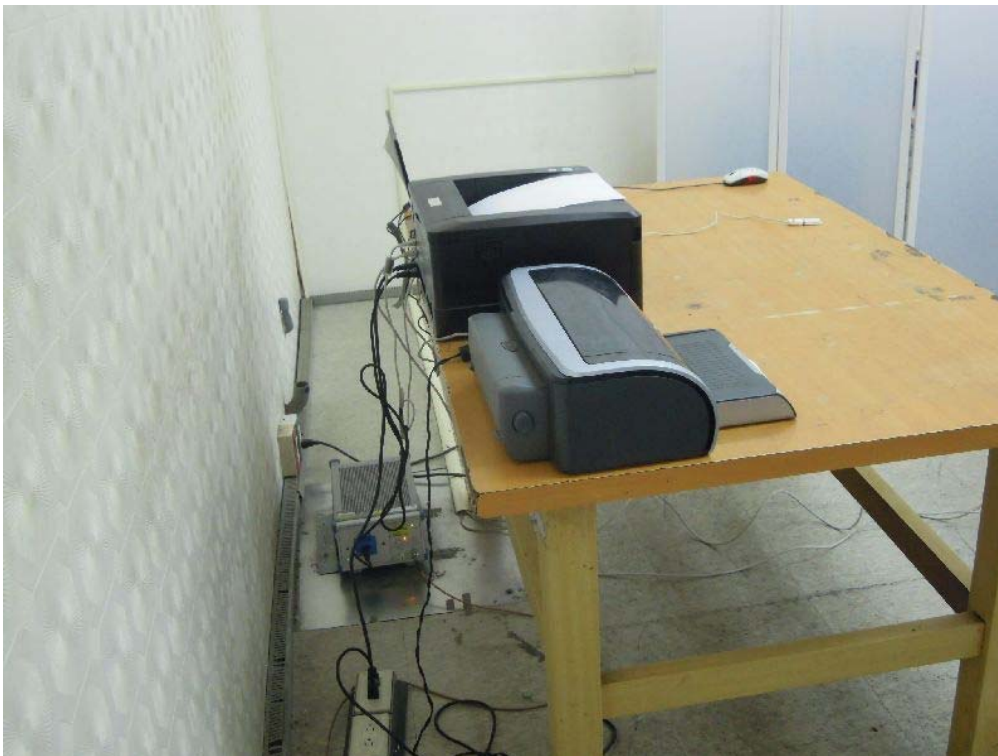

4. Asymmetric mode Conducted Emissions

4.1. Test Specification

According to EMC Standard: EN 55032

4.2. Test Setup

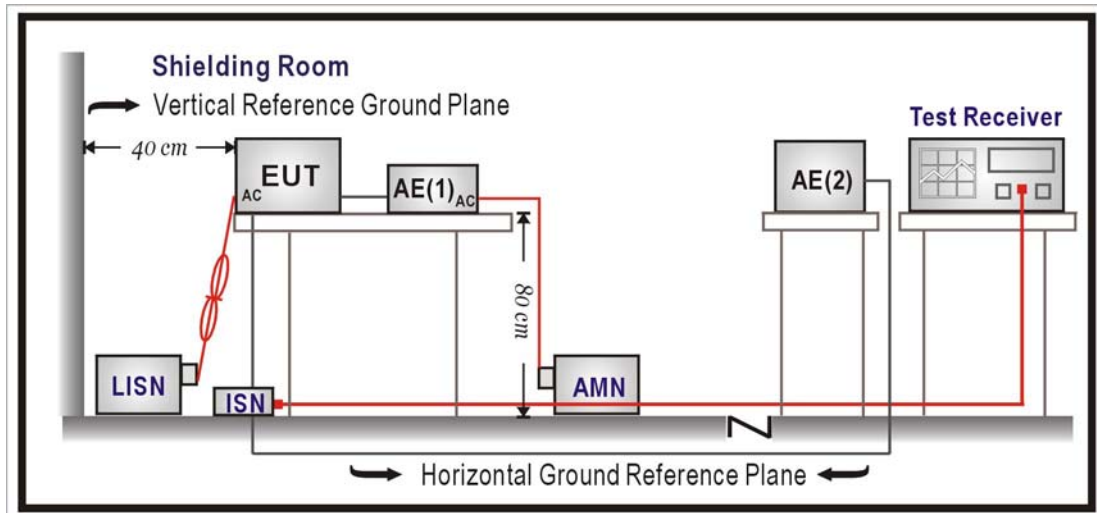

4.3. Limit

Applicable to				
1. wired network ports				
2. optical fibre port with metallic shield or tension members				
3. antenna ports				
Frequency range MHz	Coupling device	Detector type/ Bandwidth	Class B voltage limits dB(μ V)	Class B current limits dB(μ A)
0.15 – 0.5	AAN	Quasi Peak / 9 KHz	84 – 74	N / A
0.5 – 30			74	
0.15 – 0.5	AAN	Average / 9 KHz	74 – 64	
0.5 – 30			64	
0.15 – 0.5	CVP	Quasi Peak / 9 KHz	84 – 74	40 – 30
0.5 – 30	And current probe		74	30
0.15 – 0.5	CVP	Average / 9 KHz	74 – 64	30 – 20
0.5 – 30	And current probe		64	20
0.15 – 0.5	Current Probe	Quasi Peak / 9 KHz	N / A	40 – 30
0.5 – 30				30
0.15 – 0.5	Current Probe	Average / 9 KHz		30 – 20
0.5 – 30				20

The choice of coupling device and measurement procedure is defined in EN55032:2012 Annex C.

Screened ports including TV broadcast receiver tuner ports are tested with a common-mode impedance of 150 Ω .

This is typically accomplished with the screen terminated by 150 Ω to earth.

AC mains ports that also have the function of a wired network port shall meet the limits given in EN55032:2012+AC 2013 Table A.9.

The test shall cover the entire frequency range.

The application of the voltage and/or current limits is dependent on the measurement procedure used. Refer to EN55032:2012+AC 2013 Table C.1 for applicability.

Testing is required at only one EUT supply voltage and frequency.

Applicable to ports listed above and intended to connect to cables longer than 3 m

Remarks:

The limit decreases linearly with the logarithm of the frequency in the range 0.15 MHz~0.50 MHz.

4.4. Test Procedure

Telecommunication Port:

The mains voltage shall be supplied to the EUT via the LISN when the measurement of telecommunication port is performed. The common mode disturbances at the telecommunication port shall be connected to the ISN, which is 150 ohm impedance.

Both alternative cables are tested related to the LCL requested. The measurement range is from 150kHz to 30MHz. The bandwidth of measurement is set to 9kHz.

The 55dB LCL ISN is used for cat. 3 cable, 65dB LCL ISN is used for cat. 5 and 75dB LCL ISN is used for cat. 6 Cable.

4.5. Deviation from Test Standard

No deviation.

4.6. Test Result

Site : SR2	Time : 2016/1/24 - 13:57
Limit : ISN_Voltage_B_00M_QP	Margin : 10
Probe : ISN_T800_Cat5 - Line1	Power : AC 230V/50Hz
EUT : Printer	Note : Mode 2: LAN Printing (110W) 10Mps (LAN Cable)

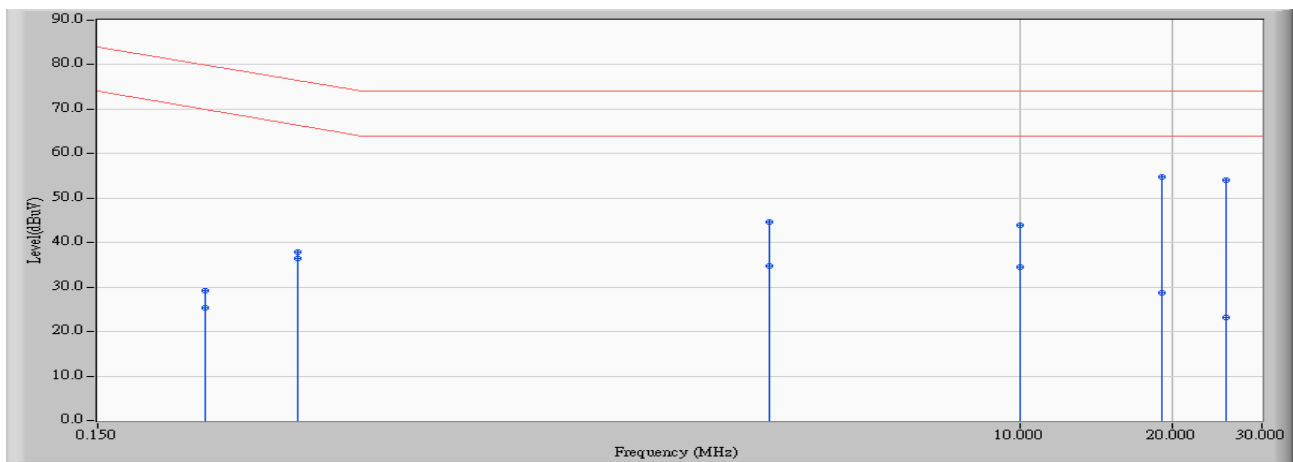

		Frequency (MHz)	Correct Factor (dB)	Reading Level (dBuV)	Measure Level (dBuV)	Margin (dB)	Limit (dBuV)	Detector Type
1		0.244	10.072	19.070	29.142	-50.817	79.959	QUASPEAK
2		0.244	10.072	15.340	25.412	-44.547	69.959	AVERAGE
3		0.373	9.944	27.870	37.814	-38.620	76.434	QUASPEAK
4		0.373	9.944	26.430	36.374	-30.060	66.434	AVERAGE
5		3.185	9.745	34.880	44.625	-29.375	74.000	QUASPEAK
6		3.185	9.745	24.980	34.725	-29.275	64.000	AVERAGE
7		9.970	9.880	34.070	43.950	-30.050	74.000	QUASPEAK
8		9.970	9.880	24.690	34.570	-29.430	64.000	AVERAGE
9	*	19.052	10.045	44.610	54.655	-19.345	74.000	QUASPEAK
10		19.052	10.045	18.670	28.715	-35.285	64.000	AVERAGE
11		25.462	10.284	43.870	54.154	-19.846	74.000	QUASPEAK
12		25.462	10.284	12.850	23.134	-40.866	64.000	AVERAGE

Note:

1. All Reading Levels are Quasi-Peak and average value.
2. " * ", means this data is the worst emission level.
3. Measurement Level = Reading Level + Correct Factor.

Site : SR2	Time : 2016/01/24 - 14:24
Limit : ISN_Voltage_B_00M_QP	Margin : 10
Probe : ISN_T800_Cat5 - Line1	Power : AC 230V/50Hz
EUT : Printer	Note : Mode 2: LAN Printing (110W) 100Mps (LAN Cable)

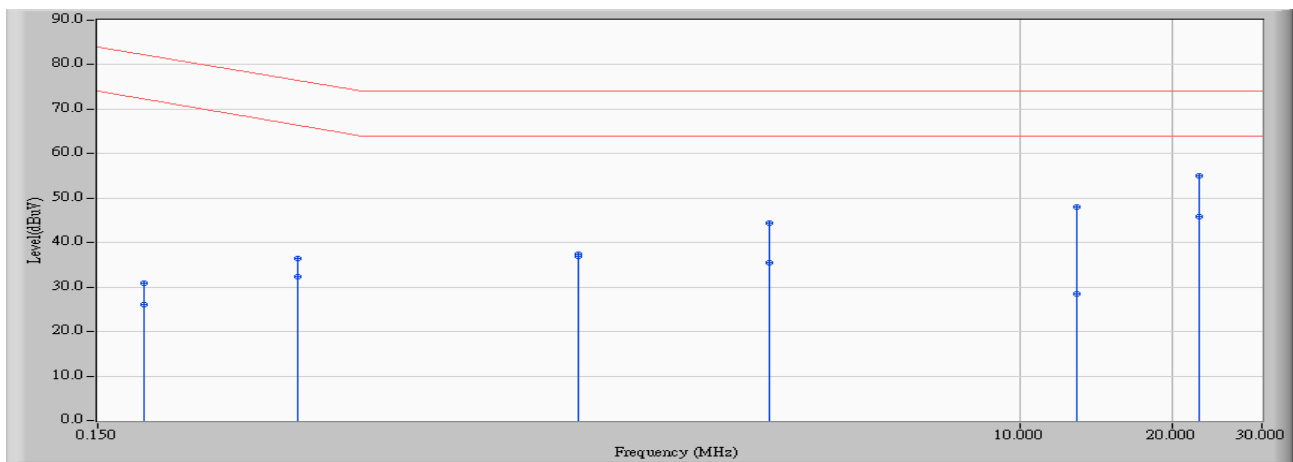

		Frequency (MHz)	Correct Factor (dB)	Reading Level (dBuV)	Measure Level (dBuV)	Margin (dB)	Limit (dBuV)	Detector Type
1		0.185	10.211	20.770	30.981	-51.277	82.258	QUASPEAK
2		0.185	10.211	15.940	26.151	-46.107	72.258	AVERAGE
3		0.373	9.944	26.550	36.494	-39.940	76.434	QUASPEAK
4		0.373	9.944	22.360	32.304	-34.130	66.434	AVERAGE
5		1.341	9.767	27.040	36.807	-37.193	74.000	QUASPEAK
6		1.341	9.767	27.640	37.407	-26.593	64.000	AVERAGE
7		3.185	9.745	34.760	44.505	-29.495	74.000	QUASPEAK
8		3.185	9.745	25.690	35.435	-28.565	64.000	AVERAGE
9		12.947	9.904	38.060	47.964	-26.036	74.000	QUASPEAK
10		12.947	9.904	18.570	28.474	-35.526	64.000	AVERAGE
11	*	22.533	10.171	44.730	54.900	-19.100	74.000	QUASPEAK
12		22.533	10.171	35.600	45.770	-18.230	64.000	AVERAGE

Note:

1. All Reading Levels are Quasi-Peak and average value.
2. " * ", means this data is the worst emission level.
3. Measurement Level = Reading Level + Correct Factor.

Site : SR2	Time : 2015/12/24 - 14:51
Limit : ISN_Voltage_B_00M_QP	Margin : 10
Probe : ISN_T800_Cat5 - Line1	Power : AC 230V/50Hz
EUT : Printer	Note : Mode 6: LAN Printing (72W) 10Mps (LAN Cable)

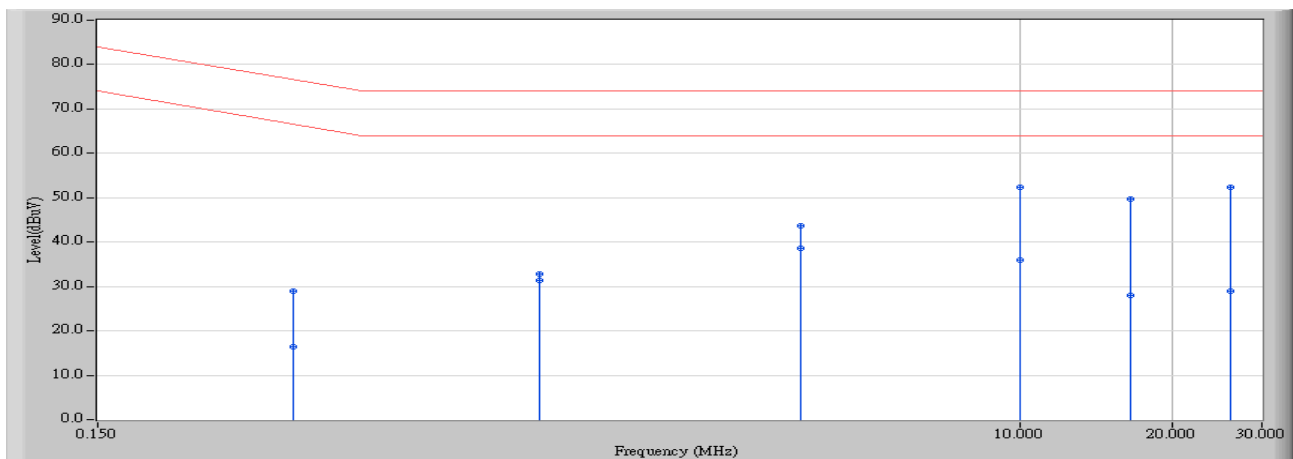

		Frequency (MHz)	Correct Factor (dB)	Reading Level (dBuV)	Measure Level (dBuV)	Margin (dB)	Limit (dBuV)	Detector Type
1		0.365	9.951	18.920	28.870	-47.747	76.617	QUASPEAK
2		0.365	9.951	6.400	16.350	-50.267	66.617	AVERAGE
3		1.123	9.773	23.030	32.803	-41.197	74.000	QUASPEAK
4		1.123	9.773	21.490	31.263	-32.737	64.000	AVERAGE
5		3.685	9.751	33.960	43.711	-30.289	74.000	QUASPEAK
6		3.685	9.751	28.930	38.681	-25.319	64.000	AVERAGE
7		10.000	9.881	42.450	52.331	-21.669	74.000	QUASPEAK
8		10.000	9.881	25.970	35.851	-28.149	64.000	AVERAGE
9		16.548	9.966	39.630	49.596	-24.404	74.000	QUASPEAK
10		16.548	9.966	17.930	27.896	-36.104	64.000	AVERAGE
11	*	26.013	10.303	42.010	52.313	-21.687	74.000	QUASPEAK
12		26.013	10.303	18.620	28.923	-35.077	64.000	AVERAGE

Note:

1. All Reading Levels are Quasi-Peak and average value.
2. " * ", means this data is the worst emission level.
3. Measurement Level = Reading Level + Correct Factor.

Site : SR2	Time : 2015/12/24 - 14:48
Limit : ISN_Voltage_B_00M_QP	Margin : 10
Probe : ISN_T800_Cat5 - Line1	Power : AC 230V/50Hz
EUT : Printer	Note : Mode 6: LAN Printing (72W) 100Mps (LAN Cable)

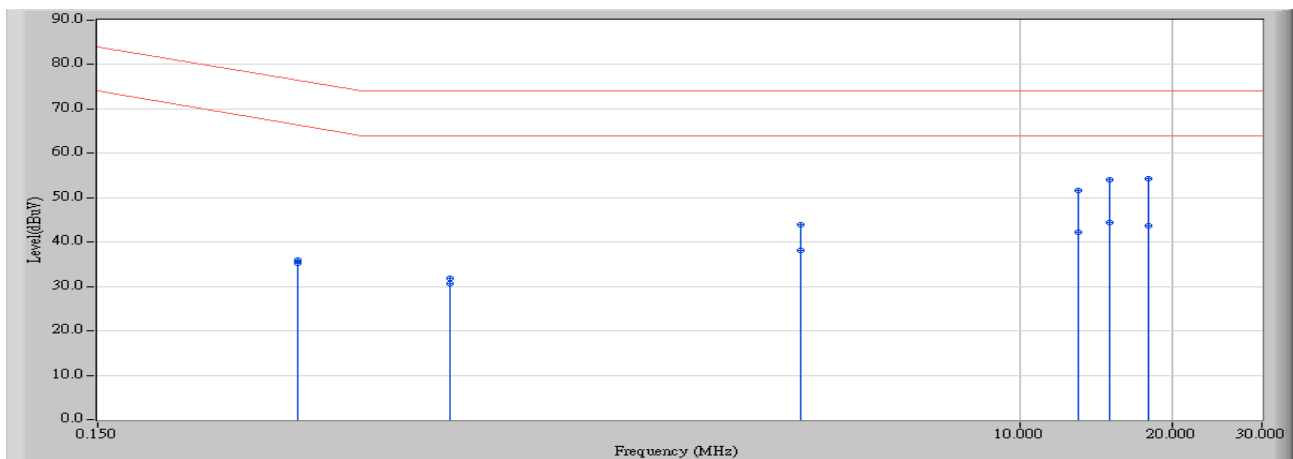

		Frequency (MHz)	Correct Factor (dB)	Reading Level (dBuV)	Measure Level (dBuV)	Margin (dB)	Limit (dBuV)	Detector Type
1		0.373	9.944	25.920	35.864	-40.577	76.442	QUASPEAK
2		0.373	9.944	25.310	35.254	-31.187	66.442	AVERAGE
3		0.748	9.819	22.060	31.879	-42.121	74.000	QUASPEAK
4		0.748	9.819	20.820	30.639	-33.361	64.000	AVERAGE
5		3.685	9.751	34.180	43.931	-30.069	74.000	QUASPEAK
6		3.685	9.751	28.420	38.171	-25.829	64.000	AVERAGE
7		13.005	9.904	41.730	51.634	-22.366	74.000	QUASPEAK
8		13.005	9.904	32.300	42.204	-21.796	64.000	AVERAGE
9		15.021	9.930	44.160	54.090	-19.910	74.000	QUASPEAK
10	*	15.021	9.930	34.420	44.350	-19.650	64.000	AVERAGE
11		17.892	10.004	44.250	54.254	-19.746	74.000	QUASPEAK
12		17.892	10.004	33.750	43.754	-20.246	64.000	AVERAGE

Note:

1. All Reading Levels are Quasi-Peak and average value.
2. " * ", means this data is the worst emission level.
3. Measurement Level = Reading Level + Correct Factor.

4.7. Test Photograph

Test Mode : Mode 2: LAN Printing (110W)

Description : Front View of Asymmetric mode Conducted Emissions Test Setup (LAN Cable)



Test Mode : Mode 2: LAN Printing (110W)

Description : Back View of Asymmetric mode Conducted Emissions Test Setup (LAN Cable)

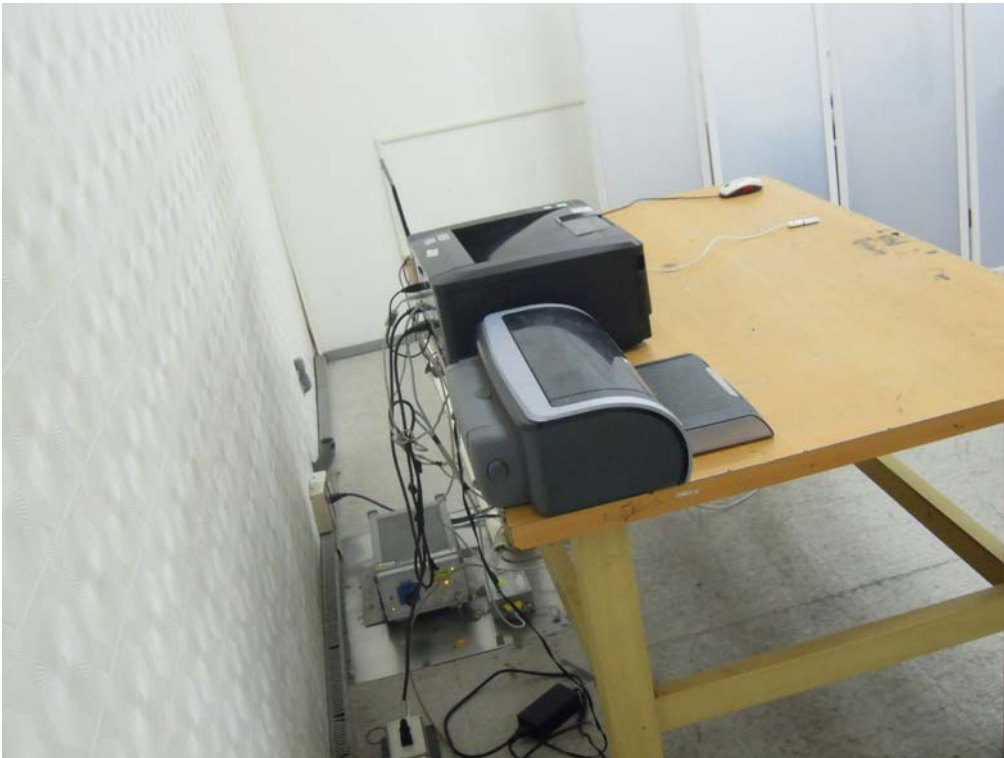

Test Mode : Mode 6: LAN Printing (72W)
Description : Front View of Asymmetric mode Conducted Emissions Test Setup (LAN Cable)



Test Mode : Mode 6: LAN Printing (72W)
Description : Back View of Asymmetric mode Conducted Emissions Test Setup (LAN Cable)

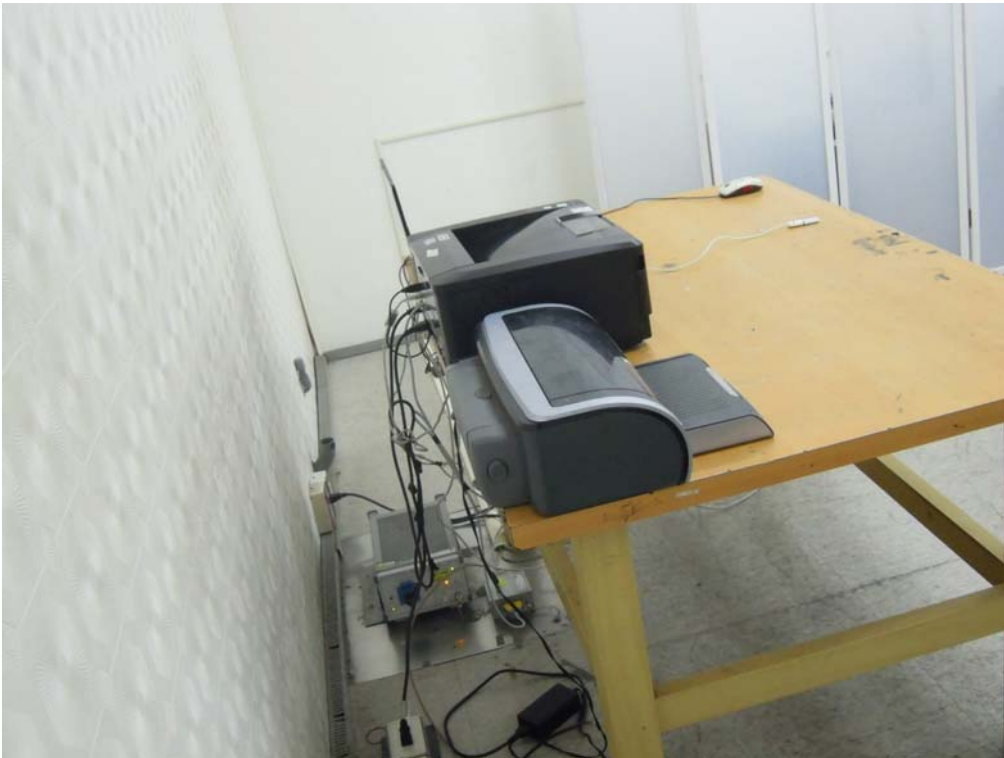

5. Radiated Emissions

5.1. Test Specification

According to EMC Standard : EN 55032

5.2. Test Setup

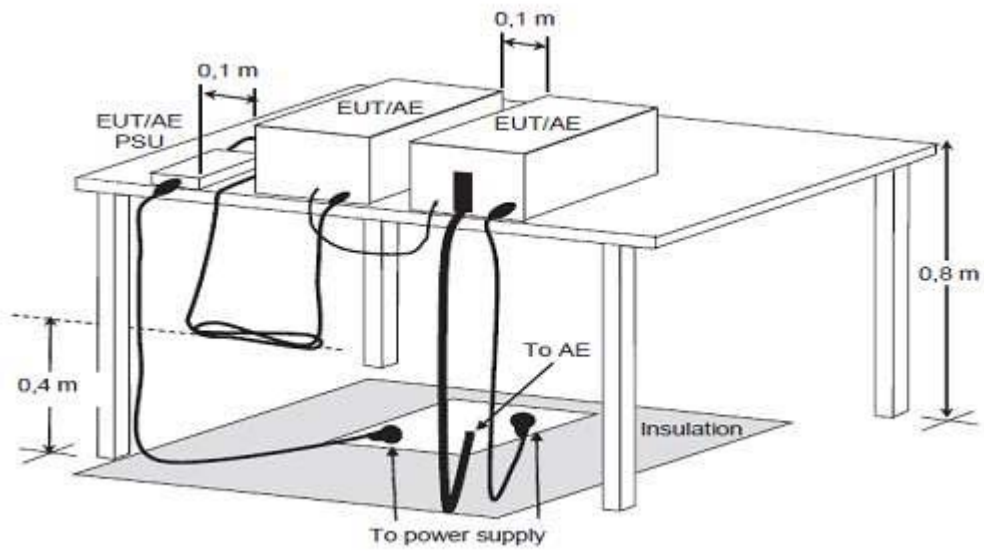

5.3. Limit

Radiated emissions at frequencies up to 1 GHz

Frequency range (MHz)	Measurement		Class B Limits dB(µV/m)
	Distance (m)	Detector type/ Bandwidth	
30 - 230	10	Quasi Peak / 120 KHz	30
230 - 1 000			37
30 - 230	3		40
230 - 1000			47

Apply only 3m or 10m across the entire frequency range.

Radiated emissions at frequencies above 1 GHz

Frequency range (MHz)	Measurement		Class B Limits dB(µV/m)
	Distance (m)	Detector type/ Bandwidth	
1000 - 3000	3	Average / 1 MHz	50
3000 - 6000			54
1000 - 3000		Peak / 1 MHz	70
3000 - 6000			74

Both apply across the frequency range from 1000 MHz to the highest required frequency of measurement derived from

Remark:

1. The tighter limit shall apply at the edge between two frequency bands.
2. Distance refers to the distance in meters between the measuring instrument antenna and the closed point of any part of the device or system.
3. RF Voltage (dBuV/m) = 20 log RF Voltage (uV/m)

Required highest frequency for radiated measurement

Highest frequency generated or used in the device or on which the device operates or tunes (MHz)	Upper frequency of measurement range (MHz)
Below 108	1000
108 – 500	2000
500 – 1000	5000
Above 1000	5 th harmonic of the highest frequency or 6 GHz, whichever is lower

Radiated emissions from FM receivers

Frequency range (MHz)	Measurement		Limits dB(μ V/m)		
	Distance (m)	Detector type/ Bandwidth	Fundamental	Harmonics	
30 - 230	10	Quasi Peak / 120 KHz	50	42	
230 - 300				42	
300 - 1000				46	
30 - 230	3		Quasi Peak / 120 KHz	60	52
230 - 300					52
300 - 1000					56

Apply only 3m or 10m across the entire frequency range
 These relaxed limits apply only to emissions at the fundamental and harmonic frequencies of the local oscillator.
 Signals at all other frequencies shall be compliant with the limits given in Table "Requirements for radiated emissions at frequencies up to 1GHz for Class B equipment."

Radiated emissions from outdoor units of home satellite receiving systems

Frequency range (MHz)	Measurement		Limits
	Distance (m)	Detector type/ Bandwidth	
30 - 230	10	Quasi Peak / 120 KHz	40 dB(μ V/m)
230 - 1 000			47 dB(μ V/m)
1000 - 2500	3	Average / 1 MHz	50 dB(μ V/m)
2500 - 18000			64 dB(μ V/m)
1000 - 18000	3	Average / 1 MHz	37 dB(μ V/m)
1000 - 18000	N/A	Average / 1 MHz	30 dBpW

5.4. Test Procedure

The EUT and its simulators are placed on a turn table which is 0.8 meter above ground. The turn table can rotate 360 degrees to determine the position of the maximum emission level. The EUT was positioned such that the distance from antenna to the EUT was 10 meters. The antenna can move up and down between 1 meter and 4 meters to find out the maximum emission level.

All cable leaving the table-top EUT for a connection outside the test site (for example, mains cable, telephone lines, connections to auxiliary equipment located outside the test area) shall be fitted with ferrite clamps placed on the floor at the point where the cable reached the floor.

Both horizontal and vertical polarization of the antenna are set on measurement. In order to find the maximum emission, all of the interface cables must be manipulated on radiated measurement.

Radiated emissions were investigated over the frequency range from 30MHz to 1GHz using a receiver bandwidth of 120kHz. Radiated was performed at an antenna to EUT distance of 10 meters.

Radiated emissions were investigated over the frequency range from 1GHz to 6GHz using a receiver bandwidth of 1MHz. Radiated was performed at an antenna to EUT distance of 3 meters.

5.5. Deviation from Test Standard

No deviation.

5.6. Test Result

Site : SITE3	Time : 2016/04/15 - 10:54
Limit : CISPR_B_10M_QP	Margin : 6
Probe : Site3_10M-3_0426 - HORIZONTAL	Power : AC 230V/50Hz
EUT : Printer	Note : Mode 1: PC Printing (110W)

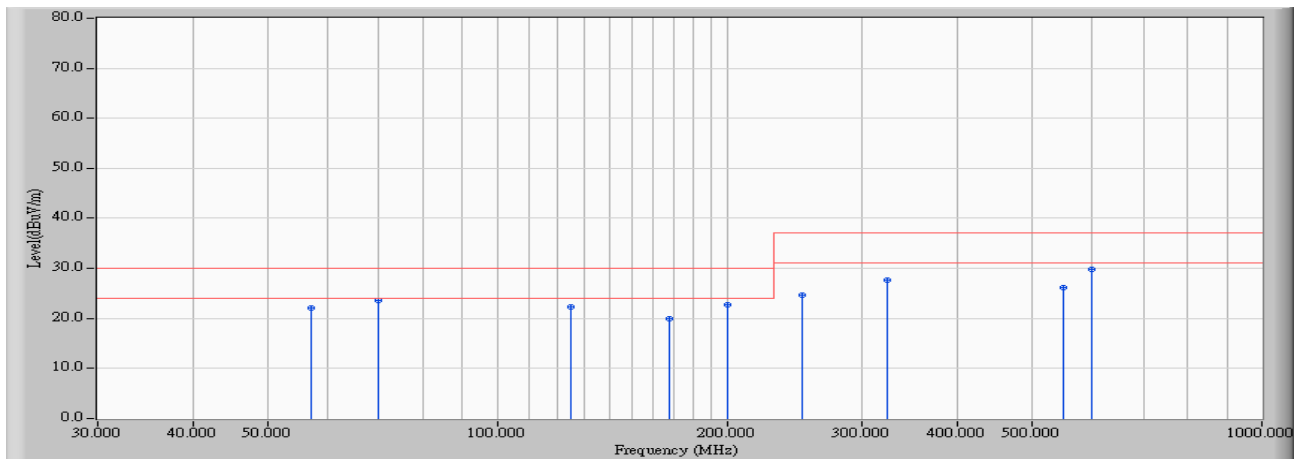

	Frequency (MHz)	Correct Factor (dB)	Reading Level (dBuV)	Measure Level (dBuV/m)	Margin (dB)	Limit (dBuV/m)	Detector Type
1	57.000	10.138	12.000	22.138	-7.862	30.000	QUASPEAK
2	* 70.000	8.312	15.200	23.512	-6.488	30.000	QUASPEAK
3	125.000	13.159	9.110	22.269	-7.731	30.000	QUASPEAK
4	168.000	11.934	7.910	19.844	-10.156	30.000	QUASPEAK
5	200.000	11.881	10.870	22.751	-7.249	30.000	QUASPEAK
6	250.000	17.252	7.350	24.602	-12.398	37.000	QUASPEAK
7	323.800	19.112	8.470	27.581	-9.419	37.000	QUASPEAK
8	550.000	24.107	2.070	26.177	-10.823	37.000	QUASPEAK
9	600.000	25.972	3.850	29.823	-7.177	37.000	QUASPEAK

Note:

1. All Reading Levels are Quasi-Peak value.
2. “ * ”, means this data is the worst emission level.
3. Measurement Level = Reading Level + Correct Factor.

Site : CB1	Time : 2015/12/09 - 10:52
Limit : CISPR_22_B_(Above_1G)_3M_PK	Margin : 0
Probe : CB1_FCC_EFS_1-18G-1_0901 - HORIZONTAL	Power : AC 230V/50Hz
EUT : Printer	Note : Mode 1: PC Printing (110W)

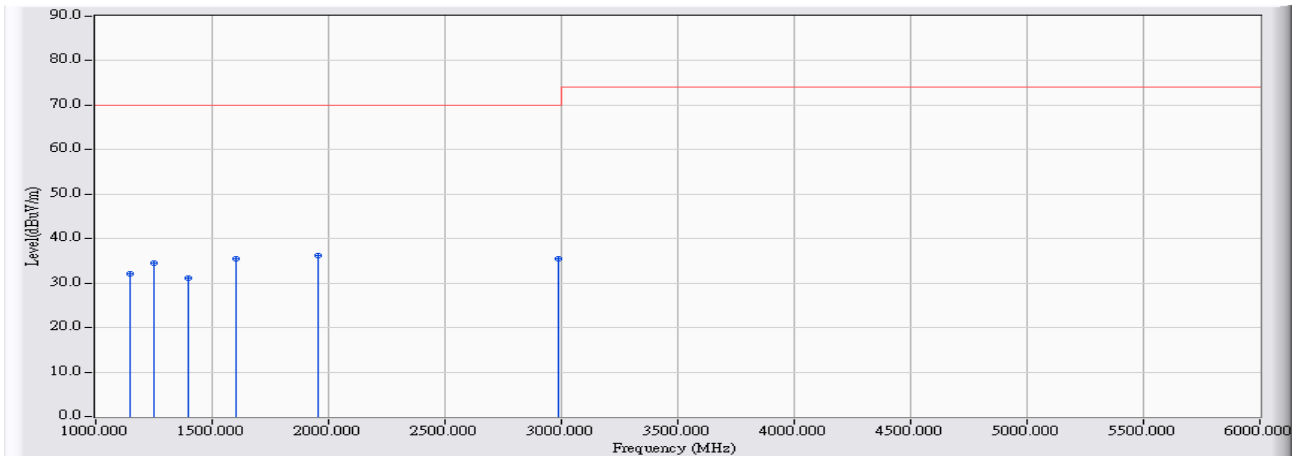

	Frequency (MHz)	Correct Factor (dB)	Reading Level (dBuV)	Measure Level (dBuV/m)	Margin (dB)	Limit (dBuV/m)	Detector Type
1	1146.000	-17.744	49.870	32.126	-37.874	70.000	PEAK
2	1252.000	-17.498	51.990	34.492	-35.508	70.000	PEAK
3	1398.000	-17.136	48.380	31.244	-38.756	70.000	PEAK
4	1600.000	-16.756	52.300	35.544	-34.456	70.000	PEAK
5	* 1952.000	-16.362	52.560	36.198	-33.802	70.000	PEAK
6	2985.000	-13.430	48.900	35.470	-34.530	70.000	PEAK

Note:

1. All Readings below 1GHz are Quasi-Peak, above are performed with peak and/or average measurements as necessary.
2. “ * ”, means this data is the worst emission level.
3. Measurement Level = Reading Level + Correct Factor
4. The average measurement was not performed when the peak measured data under the limit of average detection. If the readings given are average, peak measurement should also be supplied.

Site : SITE3	Time : 2016/04/15 - 10:54
Limit : CISPR_B_10M_QP	Margin : 6
Probe : Site3_10M-3_0426 - VERTICAL	Power : AC 230V/50Hz
EUT : Printer	Note : Mode 1: PC Printing (110W)

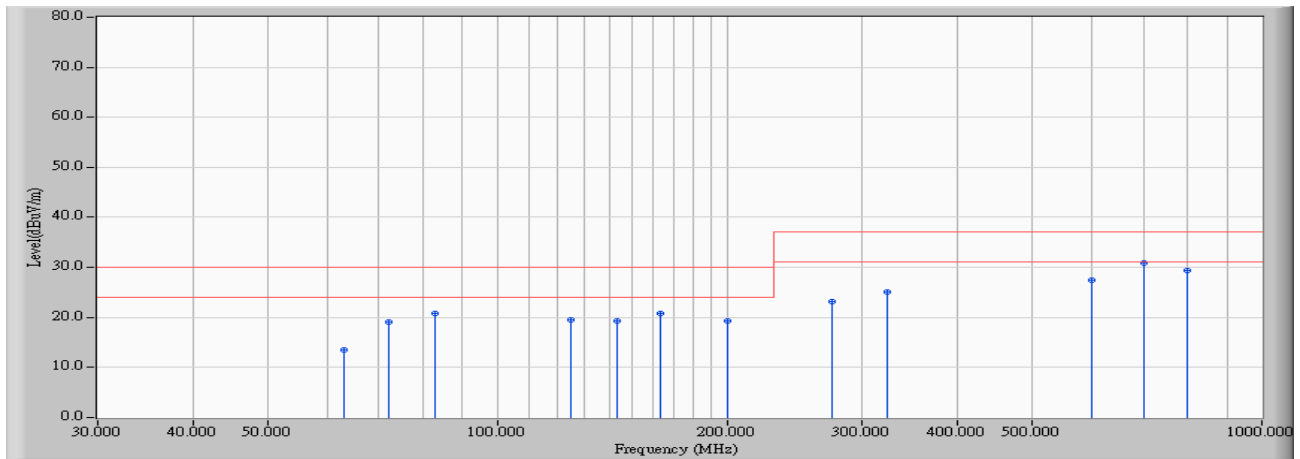

	Frequency (MHz)	Correct Factor (dB)	Reading Level (dBuV)	Measure Level (dBuV/m)	Margin (dB)	Limit (dBuV/m)	Detector Type
1	63.000	6.890	6.670	13.560	-16.440	30.000	QUASPEAK
2	72.000	8.572	10.600	19.172	-10.828	30.000	QUASPEAK
3	83.010	12.728	8.040	20.768	-9.232	30.000	QUASPEAK
4	124.525	13.474	6.070	19.544	-10.456	30.000	QUASPEAK
5	143.575	14.635	4.630	19.265	-10.735	30.000	QUASPEAK
6	163.550	14.757	6.140	20.898	-9.102	30.000	QUASPEAK
7	200.000	11.402	7.810	19.212	-10.788	30.000	QUASPEAK
8	274.000	17.468	5.720	23.188	-13.812	37.000	QUASPEAK
9	323.825	17.511	7.690	25.200	-11.800	37.000	QUASPEAK
10	600.000	24.976	2.410	27.386	-9.614	37.000	QUASPEAK
11	* 700.000	29.331	1.530	30.861	-6.139	37.000	QUASPEAK
12	800.000	26.600	2.850	29.450	-7.550	37.000	QUASPEAK

Note:

1. All Reading Levels are Quasi-Peak value.
2. " * ", means this data is the worst emission level.
3. Measurement Level = Reading Level + Correct Factor.

Site : CB1	Time : 2015/12/09 - 10:54
Limit : CISPR_22_B_(Above_1G)_3M_PK	Margin : 0
Probe : CB1_FCC_EFS_1-18G-1_0901 - VERTICAL	Power : AC 230V/50Hz
EUT : Printer	Note : Mode 1: PC Printing (110W)

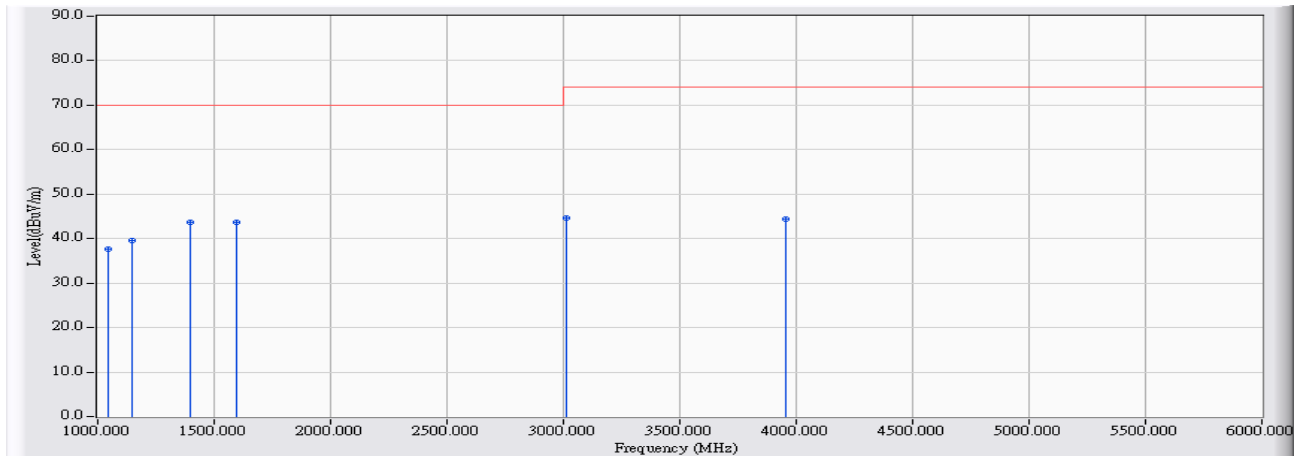

	Frequency (MHz)	Correct Factor (dB)	Reading Level (dBuV)	Measure Level (dBuV/m)	Margin (dB)	Limit (dBuV/m)	Detector Type
1	1046.000	-17.940	55.650	37.710	-32.290	70.000	PEAK
2	1145.000	-17.746	57.410	39.664	-30.336	70.000	PEAK
3	1397.000	-17.138	60.770	43.632	-26.368	70.000	PEAK
4	* 1598.000	-16.758	60.420	43.662	-26.338	70.000	PEAK
5	3014.000	-13.366	58.000	44.633	-29.367	74.000	PEAK
6	3954.000	-11.593	55.890	44.297	-29.703	74.000	PEAK

Note:

1. All Readings below 1GHz are Quasi-Peak, above are performed with peak and/or average measurements as necessary.
2. “ * ”, means this data is the worst emission level.
3. Measurement Level = Reading Level + Correct Factor
4. The average measurement was not performed when the peak measured data under the limit of average detection. If the readings given are average, peak measurement should also be supplied.

Site : SITE3	Time : 2016/04/15 - 11:06
Limit : CISPR_B_10M_QP	Margin : 6
Probe : Site3_10M-3_0426 - HORIZONTAL	Power : AC 230V/50Hz
EUT : Printer	Note : Mode 2: LAN Printing (110W)

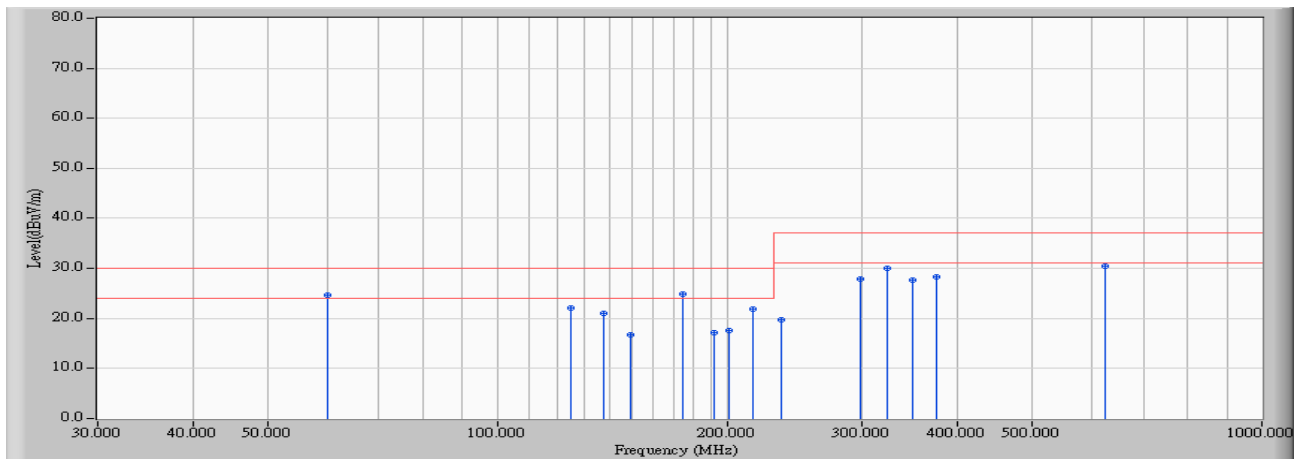

	Frequency (MHz)	Correct Factor (dB)	Reading Level (dBuV)	Measure Level (dBuV/m)	Margin (dB)	Limit (dBuV/m)	Detector Type
1	60.000	9.724	15.000	24.724	-5.276	30.000	
2	124.525	13.347	8.640	21.987	-8.013	30.000	QUASPEAK
3	137.450	12.667	8.370	21.037	-8.963	30.000	QUASPEAK
4	149.425	13.916	2.890	16.806	-13.194	30.000	QUASPEAK
5	* 175.000	12.595	12.180	24.775	-5.225	30.000	QUASPEAK
6	192.000	13.404	3.710	17.114	-12.886	30.000	QUASPEAK
7	200.675	11.894	5.660	17.554	-12.446	30.000	QUASPEAK
8	216.000	14.380	7.570	21.950	-8.050	30.000	QUASPEAK
9	235.000	14.723	5.060	19.783	-17.217	37.000	QUASPEAK
10	298.900	18.549	9.280	27.829	-9.171	37.000	QUASPEAK
11	323.775	19.116	10.930	30.045	-6.955	37.000	QUASPEAK
12	348.700	18.337	9.330	27.667	-9.333	37.000	QUASPEAK
13	375.000	18.950	9.380	28.329	-8.671	37.000	QUASPEAK
14	625.000	25.195	5.300	30.495	-6.505	37.000	QUASPEAK

Note:

1. All Reading Levels are Quasi-Peak value.
2. “ * ”, means this data is the worst emission level.
3. Measurement Level = Reading Level + Correct Factor.

Site : CB1	Time : 2015/12/09 - 10:52
Limit : CISPR_22_B_(Above_1G)_3M_PK	Margin : 0
Probe : CB1_FCC_EFS_1-18G-1_0901 - HORIZONTAL	Power : AC 230V/50Hz
EUT : Printer	Note : Mode 2: LAN Printing (110W)

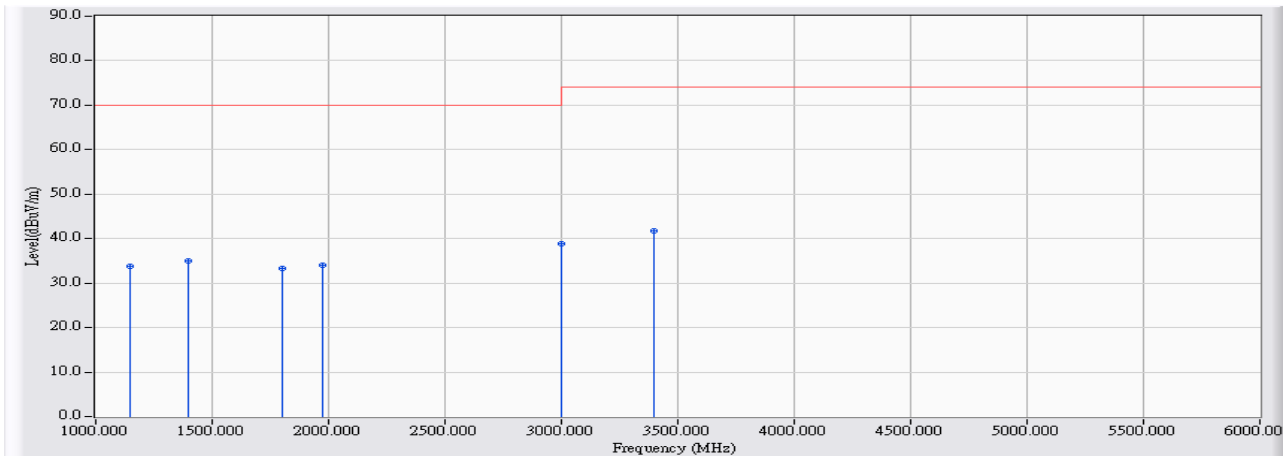

	Frequency (MHz)	Correct Factor (dB)	Reading Level (dBuV)	Measure Level (dBuV/m)	Margin (dB)	Limit (dBuV/m)	Detector Type
1	1146.000	-17.744	51.500	33.756	-36.244	70.000	PEAK
2	1399.000	-17.134	52.120	34.987	-35.013	70.000	PEAK
3	1799.000	-16.522	49.750	33.228	-36.772	70.000	PEAK
4	1973.000	-16.337	50.320	33.983	-36.017	70.000	PEAK
5	* 3000.000	-13.391	52.300	38.909	-31.091	70.000	PEAK
6	3395.000	-12.934	54.719	41.786	-32.214	74.000	PEAK

Note:

1. All Readings below 1GHz are Quasi-Peak, above are performed with peak and/or average measurements as necessary.
2. “ * ”, means this data is the worst emission level.
3. Measurement Level = Reading Level + Correct Factor
4. The average measurement was not performed when the peak measured data under the limit of average detection. If the readings given are average, peak measurement should also be supplied.

Site : SITE3	Time : 2016/04/15 - 11:06
Limit : CISPR_B_10M_QP	Margin : 6
Probe : Site3_10M-3_0426 - VERTICAL	Power : AC 230V/50Hz
EUT : Printer	Note : Mode 2: LAN Printing (110W)

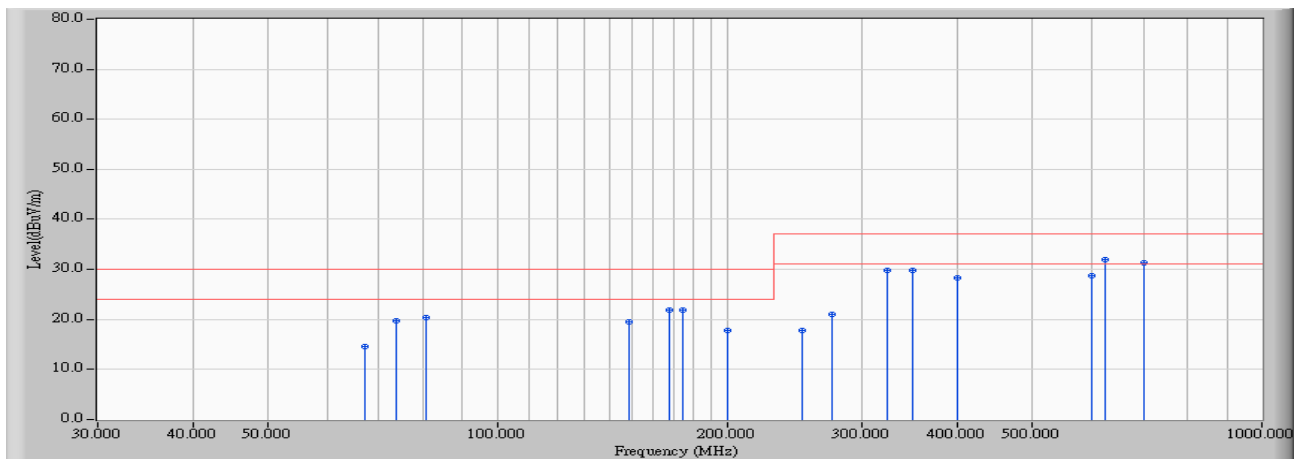

	Frequency (MHz)	Correct Factor (dB)	Reading Level (dBuV)	Measure Level (dBuV/m)	Margin (dB)	Limit (dBuV/m)	Detector Type
1	67.000	8.096	6.550	14.646	-15.354	30.000	QUASPEAK
2	73.800	8.844	10.790	19.634	-10.366	30.000	QUASPEAK
3	80.600	11.171	9.310	20.481	-9.519	30.000	QUASPEAK
4	148.450	14.391	5.020	19.411	-10.589	30.000	QUASPEAK
5	168.000	13.798	8.180	21.978	-8.022	30.000	QUASPEAK
6	175.000	13.715	8.130	21.845	-8.155	30.000	QUASPEAK
7	200.000	11.402	6.470	17.872	-12.128	30.000	QUASPEAK
8	250.000	14.990	2.820	17.811	-19.189	37.000	QUASPEAK
9	273.975	17.465	3.610	21.075	-15.925	37.000	QUASPEAK
10	323.750	17.505	12.290	29.795	-7.205	37.000	QUASPEAK
11	348.750	21.041	8.820	29.861	-7.139	37.000	QUASPEAK
12	400.000	22.498	5.910	28.408	-8.592	37.000	QUASPEAK
13	600.000	24.976	3.850	28.826	-8.174	37.000	QUASPEAK
14	* 625.000	24.797	7.100	31.897	-5.103	37.000	QUASPEAK
15	700.000	29.331	1.900	31.231	-5.769	37.000	QUASPEAK

Note:

1. All Reading Levels are Quasi-Peak value.
2. “ * ”, means this data is the worst emission level.
3. Measurement Level = Reading Level + Correct Factor.

Site : CB1	Time : 2015/12/09 - 10:53
Limit : CISPR_22_B_(Above_1G)_3M_PK	Margin : 0
Probe : CB1_FCC_EFS_1-18G-1_0901 - VERTICAL	Power : AC 230V/50Hz
EUT : Printer	Note : Mode 2: LAN Printing (110W)

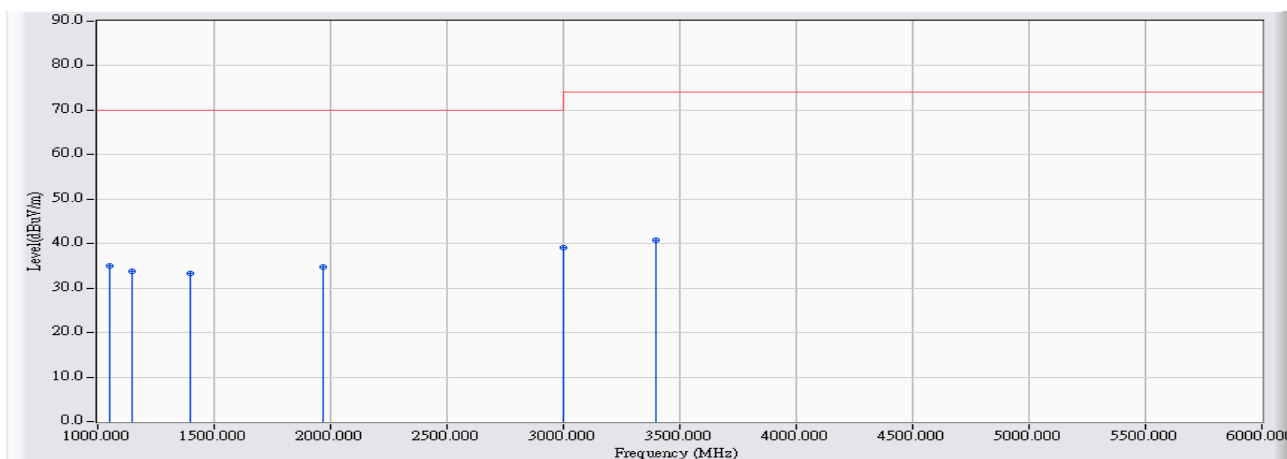

	Frequency (MHz)	Correct Factor (dB)	Reading Level (dBuV)	Measure Level (dBuV/m)	Margin (dB)	Limit (dBuV/m)	Detector Type
1	1049.000	-17.935	52.930	34.995	-35.005	70.000	PEAK
2	1146.000	-17.744	51.500	33.756	-36.244	70.000	PEAK
3	1400.000	-17.131	50.350	33.219	-36.781	70.000	PEAK
4	1966.000	-16.345	51.160	34.814	-35.186	70.000	PEAK
5	* 3000.000	-13.391	52.360	38.969	-31.031	70.000	PEAK
6	3400.000	-12.928	53.780	40.852	-33.148	74.000	PEAK

Note:

1. All Readings below 1GHz are Quasi-Peak, above are performed with peak and/or average measurements as necessary.
2. “ * ”, means this data is the worst emission level.
3. Measurement Level = Reading Level + Correct Factor
4. The average measurement was not performed when the peak measured data under the limit of average detection. If the readings given are average, peak measurement should also be supplied.

Site : SITE3	Time : 2016/04/15 - 10:29
Limit : CISPR_B_10M_QP	Margin : 6
Probe : Site3_10M-3_0426 - HORIZONTAL	Power : AC 230V/50Hz
EUT : Printer	Note : Mode 3: Documents Printing (110W)

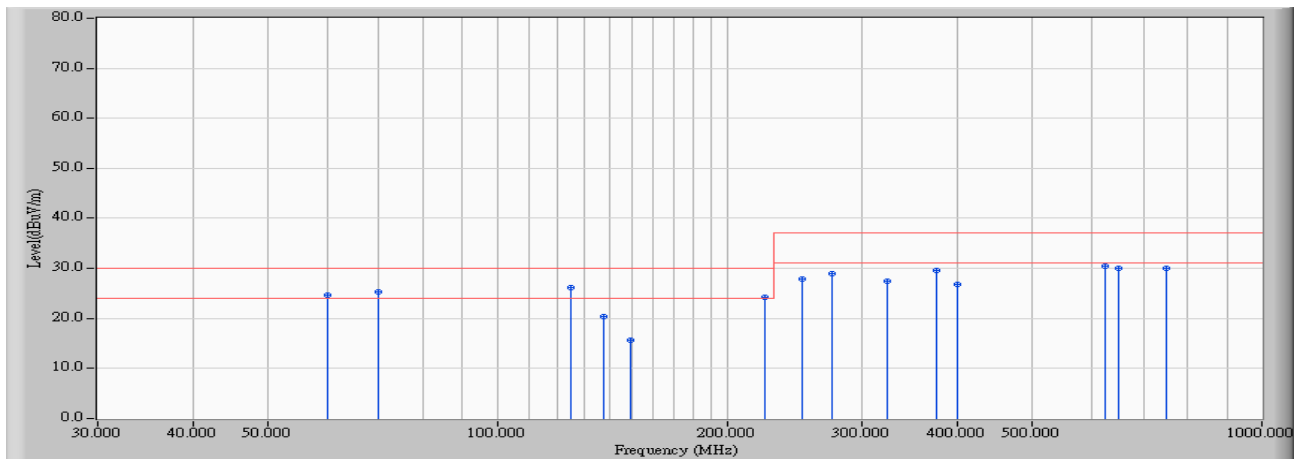

	Frequency (MHz)	Correct Factor (dB)	Reading Level (dBuV)	Measure Level (dBuV/m)	Margin (dB)	Limit (dBuV/m)	Detector Type
1	60.000	9.724	15.000	24.724	-5.276	30.000	QUASIPeAK
2	70.000	8.312	17.000	25.312	-4.688	30.000	QUASIPeAK
3	* 125.000	13.159	12.900	26.059	-3.941	30.000	QUASIPeAK
4	137.700	12.720	7.710	20.430	-9.570	30.000	QUASIPeAK
5	149.475	13.917	1.830	15.747	-14.253	30.000	QUASIPeAK
6	224.150	15.318	8.890	24.208	-5.792	30.000	QUASIPeAK
7	250.000	17.252	10.600	27.852	-9.148	37.000	QUASIPeAK
8	274.000	17.094	11.900	28.994	-8.006	37.000	QUASIPeAK
9	323.800	19.112	8.360	27.471	-9.529	37.000	QUASIPeAK
10	375.000	18.950	10.600	29.549	-7.451	37.000	QUASIPeAK
11	400.000	21.726	5.030	26.756	-10.244	37.000	QUASIPeAK
12	625.000	25.195	5.200	30.395	-6.605	37.000	QUASIPeAK
13	650.000	25.500	4.570	30.070	-6.930	37.000	QUASIPeAK
14	750.000	28.575	1.400	29.975	-7.025	37.000	QUASIPeAK

Note:

1. All Reading Levels are Quasi-Peak value.
2. “ * ”, means this data is the worst emission level.
3. Measurement Level = Reading Level + Correct Factor.

Site : CB1	Time : 2015/12/09 - 10:53
Limit : CISPR_22_B_(Above_1G)_3M_PK	Margin : 0
Probe : CB1_FCC_EFS_1-18G-1_0901 - HORIZONTAL	Power : AC 230V/50Hz
EUT : Printer	Note : Mode 3: Documents Printing (110W)

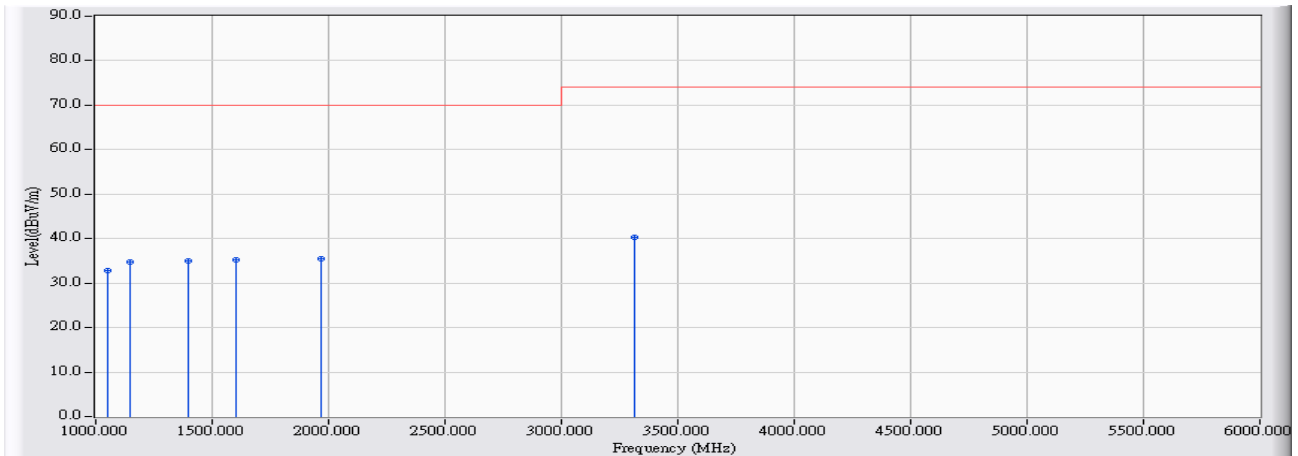

	Frequency (MHz)	Correct Factor (dB)	Reading Level (dBuV)	Measure Level (dBuV/m)	Margin (dB)	Limit (dBuV/m)	Detector Type
1	1050.000	-17.933	50.770	32.837	-37.163	70.000	PEAK
2	1150.000	-17.736	52.480	34.744	-35.256	70.000	PEAK
3	1396.000	-17.141	52.200	35.059	-34.941	70.000	PEAK
4	1600.000	-16.756	52.060	35.304	-34.696	70.000	PEAK
5	1968.000	-16.343	51.710	35.367	-34.633	70.000	PEAK
6	* 3314.000	-13.025	53.250	40.224	-33.776	74.000	PEAK

Note:

1. All Readings below 1GHz are Quasi-Peak, above are performed with peak and/or average measurements as necessary.
2. “ * ”, means this data is the worst emission level.
3. Measurement Level = Reading Level + Correct Factor
4. The average measurement was not performed when the peak measured data under the limit of average detection. If the readings given are average, peak measurement should also be supplied.

Site : SITE3	Time : 2016/04/15 - 10:28
Limit : CISPR_B_10M_QP	Margin : 6
Probe : Site3_10M-3_0426 - VERTICAL	Power : AC 230V/50Hz
EUT : Printer	Note : Mode 3: Documents Printing (110W)

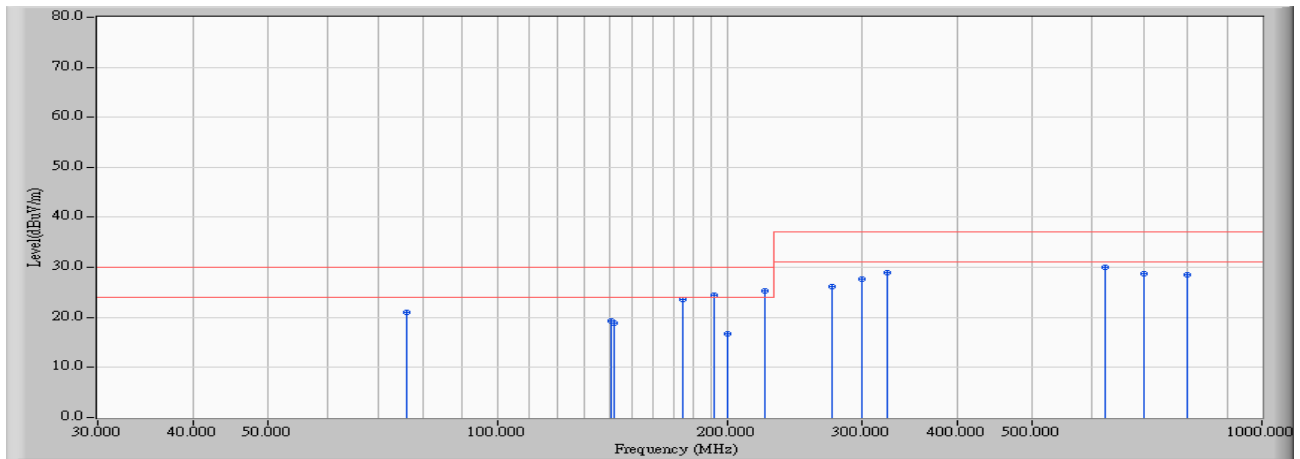

	Frequency (MHz)	Correct Factor (dB)	Reading Level (dBuV)	Measure Level (dBuV/m)	Margin (dB)	Limit (dBuV/m)	Detector Type
1	76.000	9.380	11.730	21.110	-8.890	30.000	QUASPEAK
2	141.000	14.869	4.430	19.299	-10.701	30.000	QUASPEAK
3	142.000	14.778	4.150	18.928	-11.072	30.000	QUASPEAK
4	175.000	13.715	9.780	23.495	-6.505	30.000	QUASPEAK
5	192.000	12.138	12.220	24.358	-5.642	30.000	QUASPEAK
6	200.000	11.402	5.380	16.782	-13.218	30.000	QUASPEAK
7	* 224.175	16.241	9.090	25.331	-4.669	30.000	QUASPEAK
8	274.000	17.468	8.720	26.188	-10.812	37.000	QUASPEAK
9	300.000	16.532	11.160	27.692	-9.308	37.000	QUASPEAK
10	323.750	17.505	11.440	28.945	-8.055	37.000	QUASPEAK
11	625.000	24.797	5.200	29.997	-7.003	37.000	QUASPEAK
12	700.000	29.331	-0.550	28.781	-8.219	37.000	QUASPEAK
13	800.000	26.600	1.970	28.570	-8.430	37.000	QUASPEAK

Note:

1. All Reading Levels are Quasi-Peak value.
2. " * ", means this data is the worst emission level.
3. Measurement Level = Reading Level + Correct Factor.

Site : CB1	Time : 2015/12/09 - 10:53
Limit : CISPR_22_B_(Above_1G)_3M_PK	Margin : 0
Probe : CB1_FCC_EFS_1-18G-1_0901 - VERTICAL	Power : AC 230V/50Hz
EUT : Printer	Note : Mode 3: Documents Printing (110W)

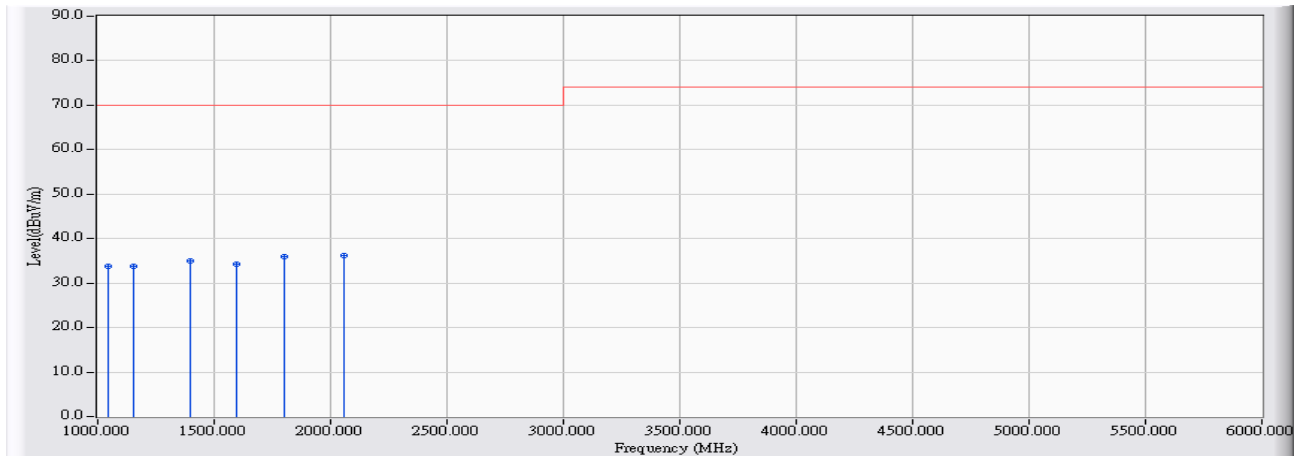

	Frequency (MHz)	Correct Factor (dB)	Reading Level (dBuV)	Measure Level (dBuV/m)	Margin (dB)	Limit (dBuV/m)	Detector Type
1	1045.000	-17.942	51.660	33.718	-36.282	70.000	PEAK
2	1152.000	-17.730	51.540	33.809	-36.191	70.000	PEAK
3	1400.000	-17.131	52.130	34.999	-35.001	70.000	PEAK
4	1595.000	-16.762	50.920	34.158	-35.842	70.000	PEAK
5	1799.000	-16.522	52.570	36.048	-33.952	70.000	PEAK
6	* 2058.000	-16.138	52.430	36.292	-33.708	70.000	PEAK

Note:

1. All Readings below 1GHz are Quasi-Peak, above are performed with peak and/or average measurements as necessary.
2. “ * ”, means this data is the worst emission level.
3. Measurement Level = Reading Level + Correct Factor
4. The average measurement was not performed when the peak measured data under the limit of average detection. If the readings given are average, peak measurement should also be supplied.

Site : SITE3	Time : 2016/04/25 - 09:20
Limit : CISPR_B_10M_QP	Margin : 6
Probe : Site3_10M-3_0426 - HORIZONTAL	Power : AC 230V/50Hz
EUT : Printer	Note : Mode 4: WiFi Printing (110W)

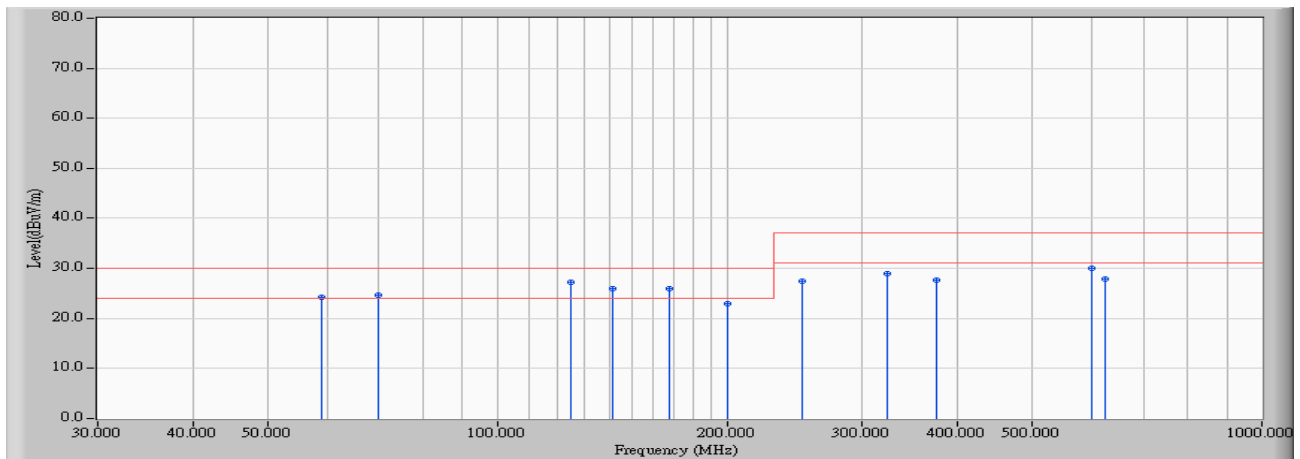

	Frequency (MHz)	Correct Factor (dB)	Reading Level (dBuV)	Measure Level (dBuV/m)	Margin (dB)	Limit (dBuV/m)	Detector Type
1	59.000	10.012	14.130	24.142	-5.858	30.000	QUASIPeAK
2	70.000	8.312	16.440	24.752	-5.248	30.000	QUASIPeAK
3	* 125.000	13.159	13.695	26.854	-3.146	30.000	QUASIPeAK
4	141.275	13.279	12.740	26.019	-3.981	30.000	QUASIPeAK
5	168.000	11.934	14.010	25.944	-4.056	30.000	QUASIPeAK
6	200.000	11.881	11.170	23.051	-6.949	30.000	QUASIPeAK
7	250.000	17.252	10.250	27.502	-9.498	37.000	QUASIPeAK
8	323.800	19.112	9.870	28.981	-8.019	37.000	QUASIPeAK
9	375.000	18.950	8.800	27.749	-9.251	37.000	QUASIPeAK
10	600.000	25.972	4.050	30.023	-6.977	37.000	QUASIPeAK
11	625.000	25.195	2.700	27.895	-9.105	37.000	QUASIPeAK

Note:

1. All Reading Levels are Quasi-Peak value.
2. “ * ”, means this data is the worst emission level.
3. Measurement Level = Reading Level + Correct Factor.

Site : CB1	Time : 2016/04/11 - 09:48
Limit : CISPR_22_B_(Above_1G)_3M_PK	Margin : 0
Probe : CB1_FCC_EFS_1-18G-1_0901 - HORIZONTAL	Power : AC 230V/50Hz
EUT : Printer	Note : Mode 4: WiFi Printing (110W)

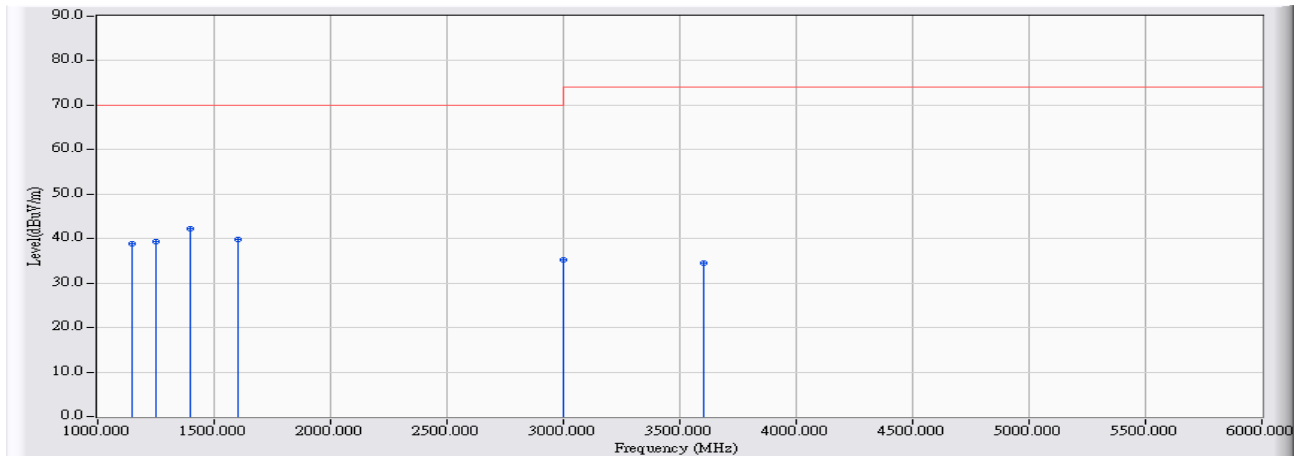

	Frequency (MHz)	Correct Factor (dB)	Reading Level (dBuV)	Measure Level (dBuV/m)	Margin (dB)	Limit (dBuV/m)	Detector Type
1	1145.000	-17.746	56.700	38.954	-31.046	70.000	PEAK
2	1252.000	-17.498	56.860	39.362	-30.638	70.000	PEAK
3	* 1396.000	-17.141	59.360	42.219	-27.781	70.000	PEAK
4	1600.000	-16.756	56.480	39.724	-30.276	70.000	PEAK
5	3000.000	-13.391	48.630	35.239	-34.761	70.000	PEAK
6	3600.000	-12.536	47.010	34.473	-39.527	74.000	PEAK

Note:

1. All Readings below 1GHz are Quasi-Peak, above are performed with peak and/or average measurements as necessary.
2. “ * ”, means this data is the worst emission level.
3. Measurement Level = Reading Level + Correct Factor
4. The average measurement was not performed when the peak measured data under the limit of average detection. If the readings given are average, peak measurement should also be supplied.

Site : SITE3	Time : 2016/04/15 - 13:02
Limit : CISPR_B_10M_QP	Margin : 6
Probe : Site3_10M-3_0426 - VERTICAL	Power : AC 230V/50Hz
EUT : Printer	Note : Mode 4: WiFi Printing (110W)

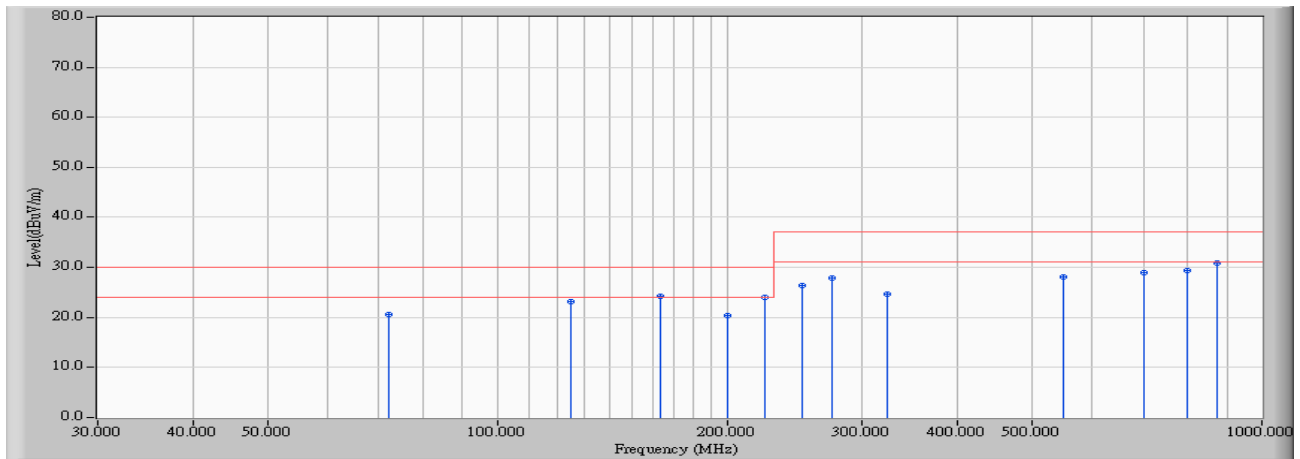

		Frequency (MHz)	Correct Factor (dB)	Reading Level (dBuV)	Measure Level (dBuV/m)	Margin (dB)	Limit (dBuV/m)	Detector Type
1		72.000	8.572	12.100	20.672	-9.328	30.000	QUASPEAK
2		125.000	13.314	9.900	23.214	-6.786	30.000	QUASPEAK
3	*	163.550	14.757	9.540	24.298	-5.702	30.000	QUASPEAK
4		200.000	11.402	8.950	20.352	-9.648	30.000	QUASPEAK
5		224.175	16.241	7.780	24.021	-5.979	30.000	QUASPEAK
6		250.000	14.990	11.410	26.401	-10.599	37.000	QUASPEAK
7		274.000	17.468	10.320	27.788	-9.212	37.000	QUASPEAK
8		323.825	17.511	7.190	24.700	-12.300	37.000	QUASPEAK
9		550.000	27.632	0.430	28.062	-8.938	37.000	QUASPEAK
10		700.000	29.331	-0.270	29.061	-7.939	37.000	QUASPEAK
11		800.000	26.600	2.850	29.450	-7.550	37.000	QUASPEAK
12		875.000	29.250	1.600	30.850	-6.150	37.000	QUASPEAK

Note:

1. All Reading Levels are Quasi-Peak value.
2. " * ", means this data is the worst emission level.
3. Measurement Level = Reading Level + Correct Factor.

Site : CB1	Time : 2016/04/11 - 09:48
Limit : CISPR_22_B_(Above_1G)_3M_PK	Margin : 0
Probe : CB1_FCC_EFS_1-18G-1_0901 - VERTICAL	Power : AC 230V/50Hz
EUT : Printer	Note : Mode 4: WiFi Printing (110W)

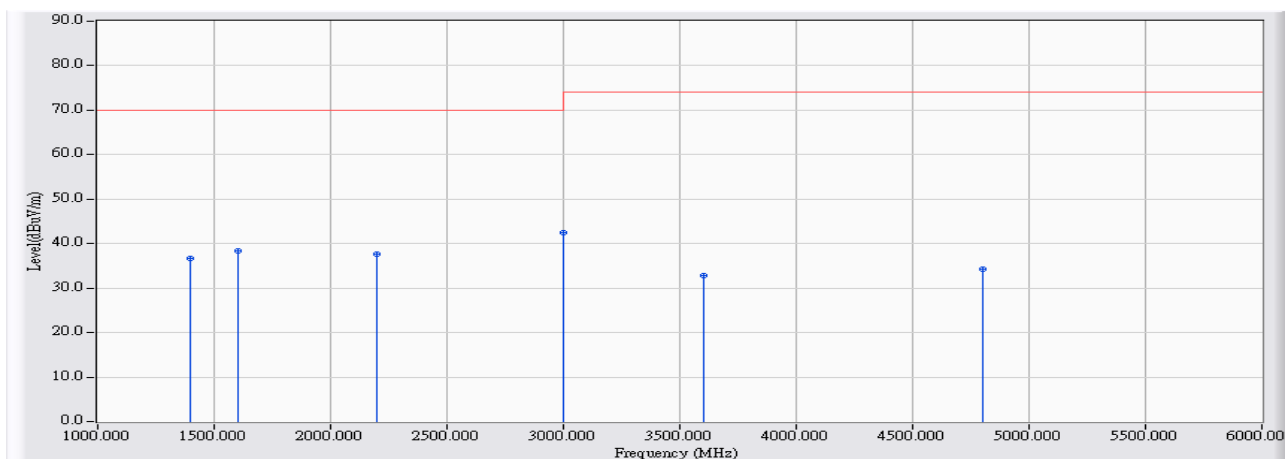

	Frequency (MHz)	Correct Factor (dB)	Reading Level (dBuV)	Measure Level (dBuV/m)	Margin (dB)	Limit (dBuV/m)	Detector Type
1	1400.000	-17.131	53.740	36.609	-33.391	70.000	PEAK
2	1600.000	-16.756	55.100	38.344	-31.656	70.000	PEAK
3	2200.000	-15.717	53.240	37.523	-32.477	70.000	PEAK
4	* 3000.000	-13.391	55.840	42.449	-27.551	70.000	PEAK
5	3600.000	-12.536	45.370	32.833	-41.167	74.000	PEAK
6	4800.000	-9.526	43.810	34.284	-39.716	74.000	PEAK

Note:

1. All Readings below 1GHz are Quasi-Peak, above are performed with peak and/or average measurements as necessary.
2. “ * ”, means this data is the worst emission level.
3. Measurement Level = Reading Level + Correct Factor
4. The average measurement was not performed when the peak measured data under the limit of average detection. If the readings given are average, peak measurement should also be supplied.

Site : SITE3	Time : 2015/11/24 - 14:53
Limit : CISPR_B_10M_QP	Margin : 6
Probe : Site3_10M-3_0426 - HORIZONTAL	Power : AC 230V/50Hz
EUT : Printer	Note : Mode 5: PC Printing (72W)

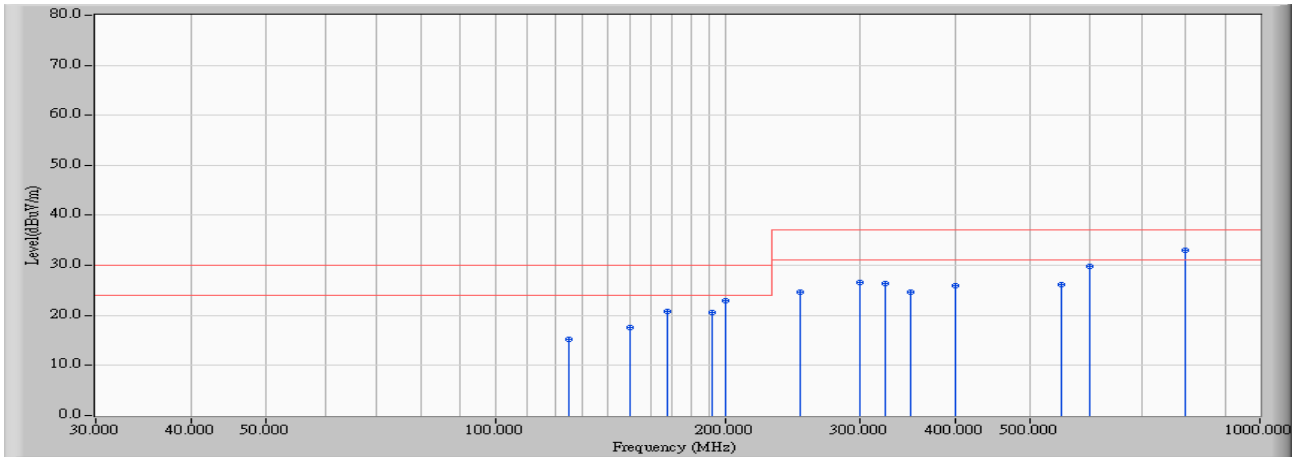

	Frequency (MHz)	Correct Factor (dB)	Reading Level (dBuV)	Measure Level (dBuV/m)	Margin (dB)	Limit (dBuV/m)	Detector Type
1	125.000	13.159	2.010	15.169	-14.831	30.000	QUASPEAK
2	150.000	13.932	3.610	17.542	-12.458	30.000	QUASPEAK
3	168.000	11.934	8.810	20.744	-9.256	30.000	QUASPEAK
4	192.000	13.404	7.100	20.504	-9.496	30.000	QUASPEAK
5	200.000	11.881	11.170	23.051	-6.949	30.000	QUASPEAK
6	250.000	17.252	7.350	24.602	-12.398	37.000	QUASPEAK
7	300.000	18.644	7.870	26.514	-10.486	37.000	QUASPEAK
8	323.800	19.112	7.370	26.481	-10.519	37.000	QUASPEAK
9	348.675	18.338	6.220	24.558	-12.442	37.000	QUASPEAK
10	400.000	21.726	4.150	25.876	-11.124	37.000	QUASPEAK
11	550.000	24.107	2.070	26.177	-10.823	37.000	QUASPEAK
12	600.000	25.972	3.850	29.823	-7.177	37.000	QUASPEAK
13	* 800.000	30.914	2.210	33.124	-3.876	37.000	QUASPEAK

Note:

1. All Reading Levels are Quasi-Peak value.
2. " * ", means this data is the worst emission level.
3. Measurement Level = Reading Level + Correct Factor.

Site : CB1	Time : 2016/04/11 - 09:59
Limit : CISPR_22_B_(Above_1G)_3M_PK	Margin : 0
Probe : CB1_FCC_EFS_1-18G-1_0901 - HORIZONTAL	Power : AC 230V/50Hz
EUT : Printer	Note : Mode 5: PC Printing (72W)

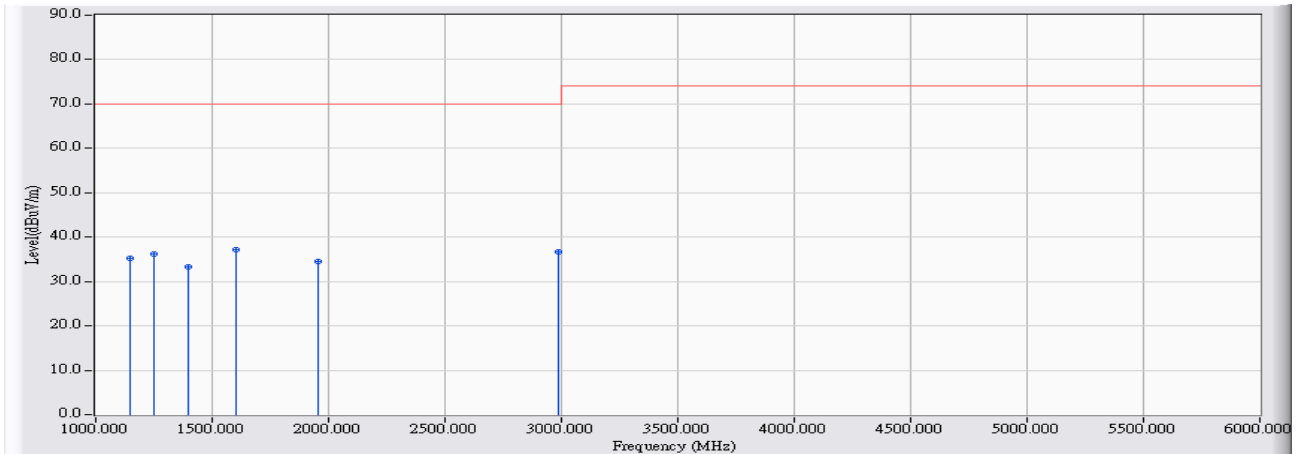

	Frequency (MHz)	Correct Factor (dB)	Reading Level (dBuV)	Measure Level (dBuV/m)	Margin (dB)	Limit (dBuV/m)	Detector Type
1	1146.000	-17.744	52.970	35.226	-34.774	70.000	PEAK
2	1252.000	-17.498	53.590	36.092	-33.908	70.000	PEAK
3	1398.000	-17.136	50.480	33.344	-36.656	70.000	PEAK
4	* 1600.000	-16.756	53.900	37.144	-32.856	70.000	PEAK
5	1952.000	-16.362	50.960	34.598	-35.402	70.000	PEAK
6	2985.000	-13.430	50.000	36.570	-33.430	70.000	PEAK

Note:

1. All Readings below 1GHz are Quasi-Peak, above are performed with peak and/or average measurements as necessary.
2. “ * ”, means this data is the worst emission level.
3. Measurement Level = Reading Level + Correct Factor
4. The average measurement was not performed when the peak measured data under the limit of average detection. If the readings given are average, peak measurement should also be supplied.

Site : SITE3	Time : 2015/11/24 - 14:36
Limit : CISPR_B_10M_QP	Margin : 6
Probe : Site3_10M-3_0426 - VERTICAL	Power : AC 230V/50Hz
EUT : Printer	Note : Mode 5: PC Printing (72W)

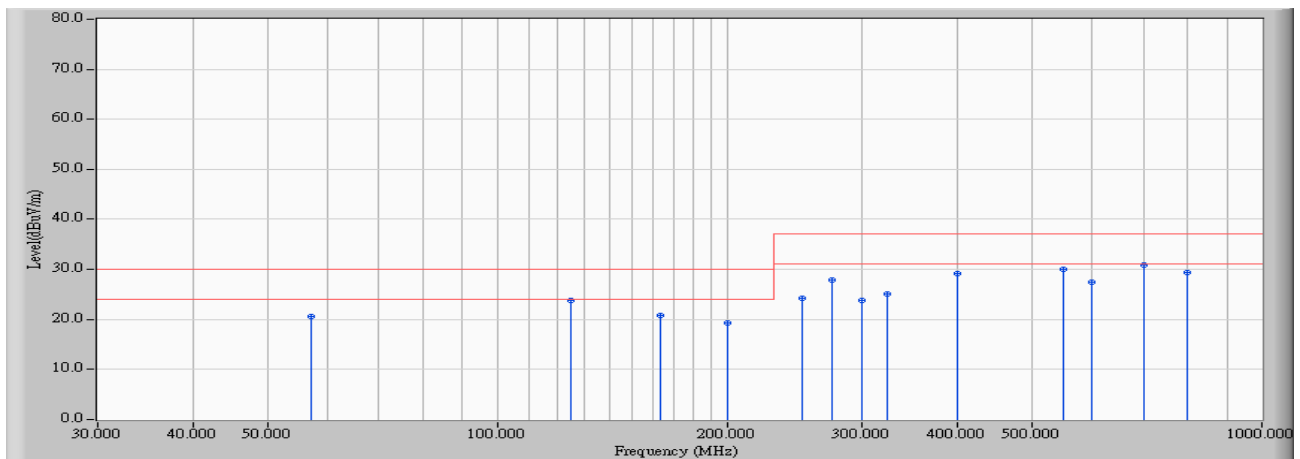

		Frequency (MHz)	Correct Factor (dB)	Reading Level (dBuV)	Measure Level (dBuV/m)	Margin (dB)	Limit (dBuV/m)	Detector Type
1		57.000	4.350	16.280	20.630	-9.370	30.000	QUASPEAK
2		124.525	13.474	10.230	23.704	-6.296	30.000	QUASPEAK
3		163.550	14.757	6.140	20.898	-9.102	30.000	QUASPEAK
4		200.000	11.402	7.810	19.212	-10.788	30.000	QUASPEAK
5		250.000	14.990	9.310	24.301	-12.699	37.000	QUASPEAK
6		274.000	17.468	10.320	27.788	-9.212	37.000	QUASPEAK
7		300.000	16.532	7.300	23.832	-13.168	37.000	QUASPEAK
8		323.825	17.511	7.490	25.000	-12.000	37.000	QUASPEAK
9		400.000	22.498	6.710	29.208	-7.792	37.000	QUASPEAK
10		550.000	27.632	2.430	30.062	-6.938	37.000	QUASPEAK
11		600.000	24.976	2.410	27.386	-9.614	37.000	QUASPEAK
12	*	700.000	29.331	1.530	30.861	-6.139	37.000	QUASPEAK
13		800.000	26.600	2.850	29.450	-7.550	37.000	QUASPEAK

Note:

1. All Reading Levels are Quasi-Peak value.
2. " * ", means this data is the worst emission level.
3. Measurement Level = Reading Level + Correct Factor.

Site : CB1	Time : 2016/04/11 - 10:00
Limit : CISPR_22_B_(Above_1G)_3M_PK	Margin : 0
Probe : CB1_FCC_EFS_1-18G-1_0901 - VERTICAL	Power : AC 230V/50Hz
EUT : Printer	Note : Mode 5: PC Printing (72W)

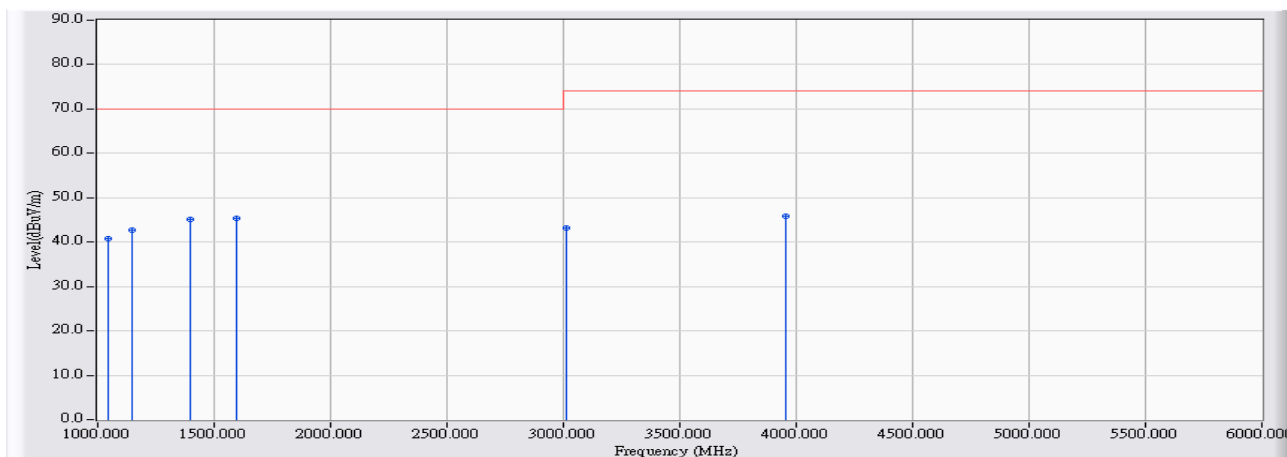

	Frequency (MHz)	Correct Factor (dB)	Reading Level (dBuV)	Measure Level (dBuV/m)	Margin (dB)	Limit (dBuV/m)	Detector Type
1	1046.000	-17.940	58.750	40.810	-29.190	70.000	PEAK
2	1145.000	-17.746	60.510	42.764	-27.236	70.000	PEAK
3	1397.000	-17.138	62.370	45.232	-24.768	70.000	PEAK
4	* 1598.000	-16.758	62.020	45.262	-24.738	70.000	PEAK
5	3014.000	-13.366	56.500	43.133	-30.867	74.000	PEAK
6	3954.000	-11.593	57.490	45.897	-28.103	74.000	PEAK

Note:

1. All Readings below 1GHz are Quasi-Peak, above are performed with peak and/or average measurements as necessary.
2. “ * ”, means this data is the worst emission level.
3. Measurement Level = Reading Level + Correct Factor
4. The average measurement was not performed when the peak measured data under the limit of average detection. If the readings given are average, peak measurement should also be supplied.

Site : SITE3	Time : 2015/11/30 - 14:40
Limit : CISPR_B_10M_QP	Margin : 6
Probe : Site3_10M-3_0426 - HORIZONTAL	Power : AC 230V/50Hz
EUT : Printer	Note : Mode 6: LAN Printing (72W)

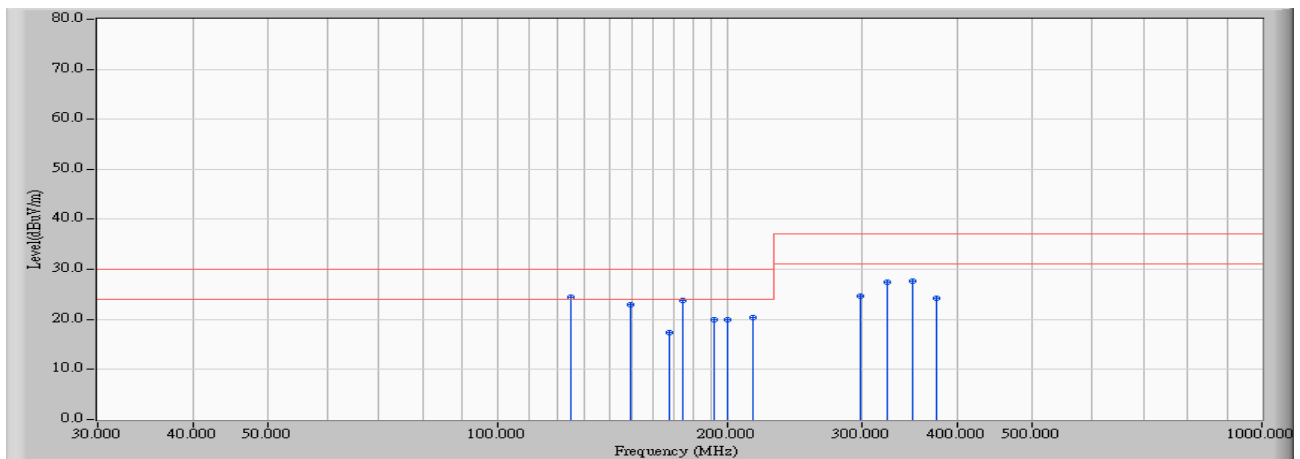

		Frequency (MHz)	Correct Factor (dB)	Reading Level (dBuV)	Measure Level (dBuV/m)	Margin (dB)	Limit (dBuV/m)	Detector Type
1	*	124.525	13.347	11.180	24.527	-5.473	30.000	QUASPEAK
2		149.425	13.916	9.070	22.986	-7.014	30.000	QUASPEAK
3		168.000	11.934	5.500	17.434	-12.566	30.000	QUASPEAK
4		175.000	12.595	11.180	23.775	-6.225	30.000	QUASPEAK
5		192.000	13.404	6.640	20.044	-9.956	30.000	QUASPEAK
6		200.000	11.881	7.970	19.851	-10.149	30.000	QUASPEAK
7		216.000	14.380	5.970	20.350	-9.650	30.000	QUASPEAK
8		298.900	18.549	6.180	24.729	-12.271	37.000	QUASPEAK
9		323.775	19.116	8.330	27.445	-9.555	37.000	QUASPEAK
10		348.700	18.337	9.330	27.667	-9.333	37.000	QUASPEAK
11		375.000	18.950	5.280	24.229	-12.771	37.000	QUASPEAK

Note:

1. All Reading Levels are Quasi-Peak value.
2. “ * ”, means this data is the worst emission level.
3. Measurement Level = Reading Level + Correct Factor.

Site : CB1	Time : 2016/04/11 - 10:00
Limit : CISPR_22_B_(Above_1G)_3M_PK	Margin : 0
Probe : CB1_FCC_EFS_1-18G-1_0901 - HORIZONTAL	Power : AC 230V/50Hz
EUT : Printer	Note : Mode 6: LAN Printing (72W)

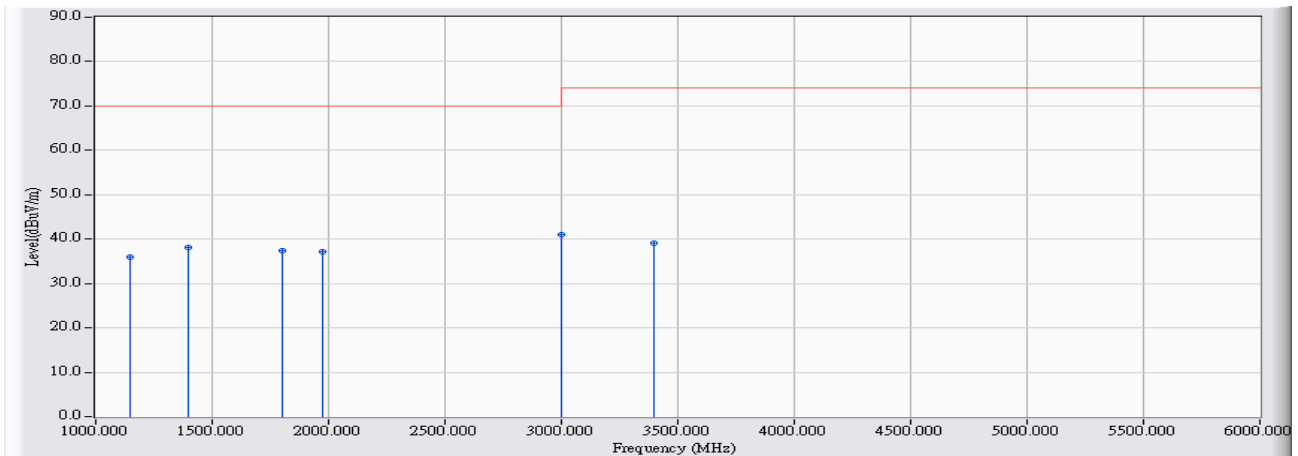

	Frequency (MHz)	Correct Factor (dB)	Reading Level (dBuV)	Measure Level (dBuV/m)	Margin (dB)	Limit (dBuV/m)	Detector Type
1	1146.000	-17.744	53.600	35.856	-34.144	70.000	PEAK
2	1399.000	-17.134	55.220	38.087	-31.913	70.000	PEAK
3	1799.000	-16.522	53.850	37.328	-32.672	70.000	PEAK
4	1973.000	-16.337	53.420	37.083	-32.917	70.000	PEAK
5	* 3000.000	-13.391	54.400	41.009	-28.991	70.000	PEAK
6	3395.000	-12.934	52.119	39.186	-34.814	74.000	PEAK

Note:

1. All Readings below 1GHz are Quasi-Peak, above are performed with peak and/or average measurements as necessary.
2. “ * ”, means this data is the worst emission level.
3. Measurement Level = Reading Level + Correct Factor
4. The average measurement was not performed when the peak measured data under the limit of average detection. If the readings given are average, peak measurement should also be supplied.

Site : SITE3	Time : 2015/11/30 - 14:22
Limit : CISPR_B_10M_QP	Margin : 6
Probe : Site3_10M-3_0426 - VERTICAL	Power : AC 230V/50Hz
EUT : Printer	Note : Mode 6: LAN Printing (72W)

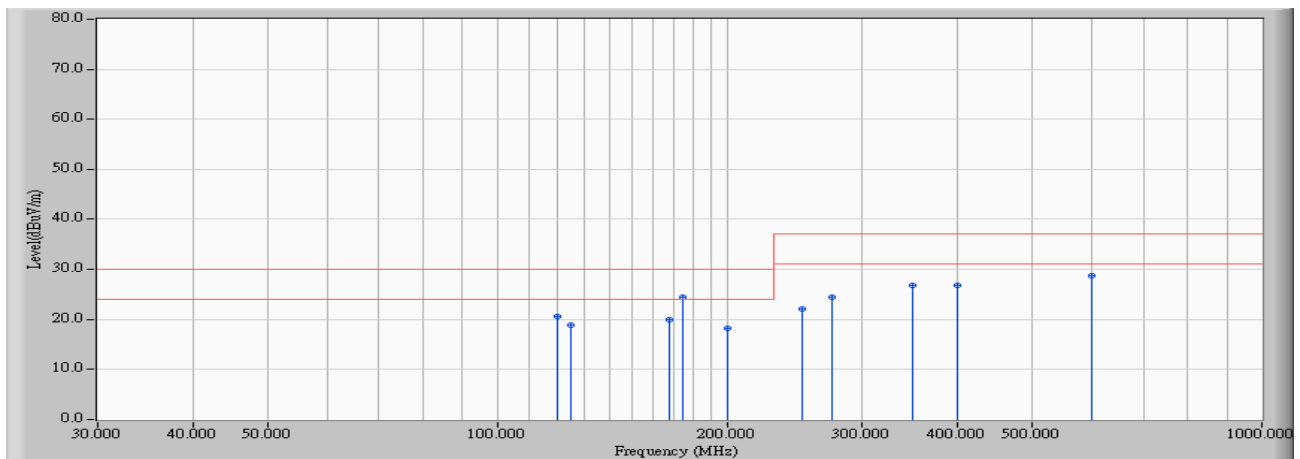

	Frequency (MHz)	Correct Factor (dB)	Reading Level (dBuV)	Measure Level (dBuV/m)	Margin (dB)	Limit (dBuV/m)	Detector Type
1	120.000	15.004	5.690	20.694	-9.306	30.000	QUASPEAK
2	125.000	13.314	5.660	18.974	-11.026	30.000	QUASPEAK
3	168.000	13.798	6.080	19.878	-10.122	30.000	QUASPEAK
4	* 175.000	13.715	10.640	24.355	-5.645	30.000	QUASPEAK
5	200.000	11.402	6.860	18.262	-11.738	30.000	QUASPEAK
6	250.000	14.990	7.180	22.171	-14.829	37.000	QUASPEAK
7	274.000	17.468	7.070	24.538	-12.462	37.000	QUASPEAK
8	348.750	21.041	5.720	26.761	-10.239	37.000	QUASPEAK
9	400.000	22.498	4.310	26.808	-10.192	37.000	QUASPEAK
10	600.000	24.976	3.750	28.726	-8.274	37.000	QUASPEAK

Note:

1. All Reading Levels are Quasi-Peak value.
2. “ * ”, means this data is the worst emission level.
3. Measurement Level = Reading Level + Correct Factor.

Site : CB1	Time : 2016/04/11 - 10:00
Limit : CISPR_22_B_(Above_1G)_3M_PK	Margin : 0
Probe : CB1_FCC_EFS_1-18G-1_0901 - VERTICAL	Power : AC 230V/50Hz
EUT : Printer	Note : Mode 6: LAN Printing (72W)

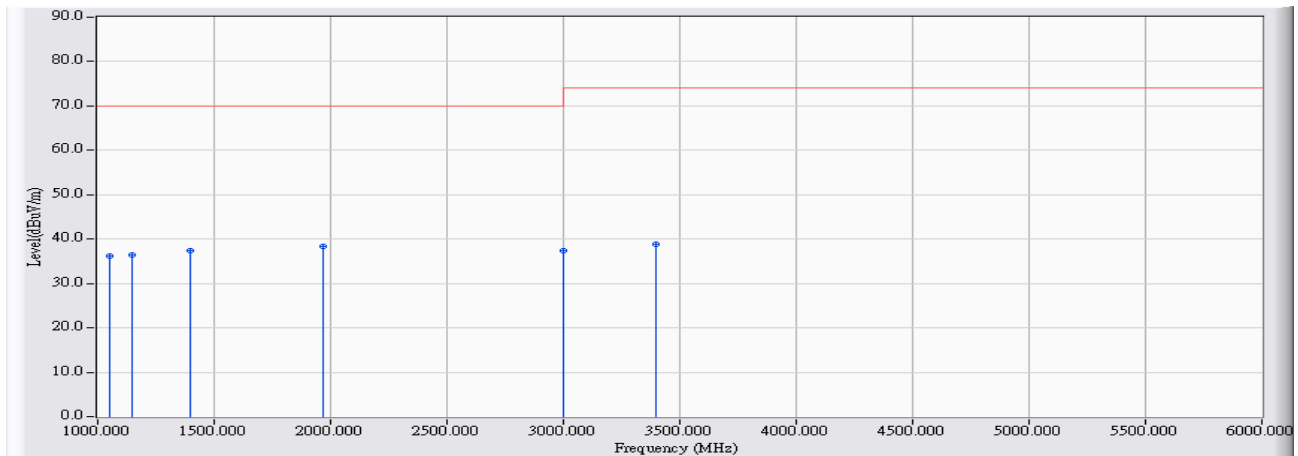

	Frequency (MHz)	Correct Factor (dB)	Reading Level (dBuV)	Measure Level (dBuV/m)	Margin (dB)	Limit (dBuV/m)	Detector Type
1	1049.000	-17.935	54.030	36.095	-33.905	70.000	PEAK
2	1146.000	-17.744	54.100	36.356	-33.644	70.000	PEAK
3	1400.000	-17.131	54.450	37.319	-32.681	70.000	PEAK
4	* 1966.000	-16.345	54.760	38.414	-31.586	70.000	PEAK
5	3000.000	-13.391	50.760	37.369	-32.631	70.000	PEAK
6	3400.000	-12.928	51.680	38.752	-35.248	74.000	PEAK

Note:

1. All Readings below 1GHz are Quasi-Peak, above are performed with peak and/or average measurements as necessary.
2. “ * ”, means this data is the worst emission level.
3. Measurement Level = Reading Level + Correct Factor
4. The average measurement was not performed when the peak measured data under the limit of average detection. If the readings given are average, peak measurement should also be supplied.

Site : SITE3	Time : 2015/11/30 - 15:14
Limit : CISPR_B_10M_QP	Margin : 6
Probe : Site3_10M-3_0426 - HORIZONTAL	Power : AC 230V/50Hz
EUT : Printer	Note : Mode 7: Documents Printing (72W)

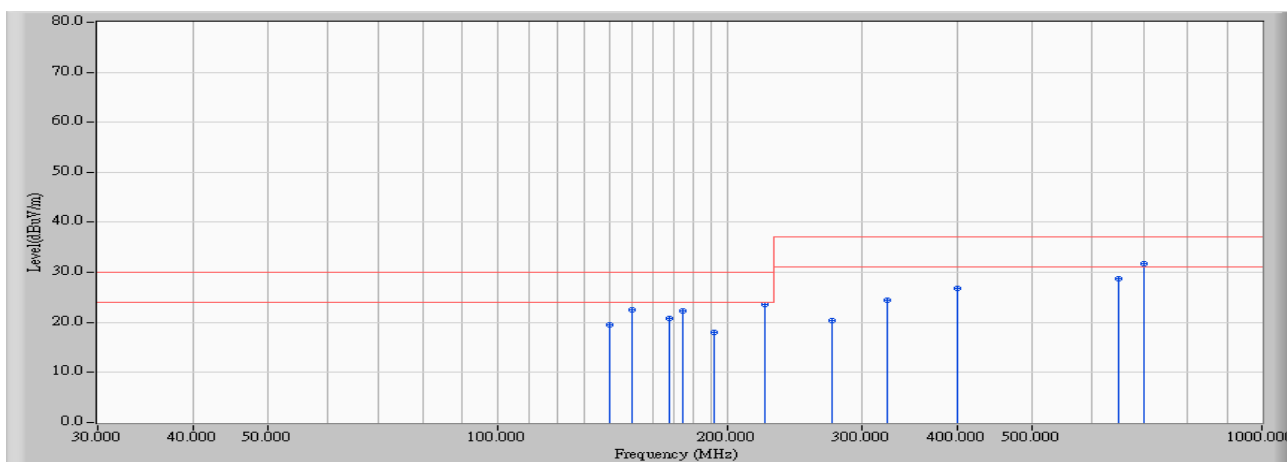

	Frequency (MHz)	Correct Factor (dB)	Reading Level (dBuV)	Measure Level (dBuV/m)	Margin (dB)	Limit (dBuV/m)	Detector Type
1	140.150	13.191	6.340	19.531	-10.469	30.000	QUASPEAK
2	150.000	13.932	8.500	22.432	-7.568	30.000	QUASPEAK
3	168.000	11.934	8.910	20.844	-9.156	30.000	QUASPEAK
4	175.000	12.595	9.620	22.215	-7.785	30.000	QUASPEAK
5	192.000	13.404	4.660	18.064	-11.936	30.000	QUASPEAK
6	224.150	15.318	8.290	23.608	-6.392	30.000	QUASPEAK
7	274.000	17.094	3.300	20.394	-16.606	37.000	QUASPEAK
8	323.800	19.112	5.260	24.371	-12.629	37.000	QUASPEAK
9	400.000	21.726	5.030	26.756	-10.244	37.000	QUASPEAK
10	650.000	25.500	3.170	28.670	-8.330	37.000	QUASPEAK
11	* 700.000	28.432	3.250	31.682	-5.318	37.000	QUASPEAK

Note:

1. All Reading Levels are Quasi-Peak value.
2. “ * ”, means this data is the worst emission level.
3. Measurement Level = Reading Level + Correct Factor.

Site : CB1	Time : 2016/04/11 - 10:00
Limit : CISPR_22_B_(Above_1G)_3M_PK	Margin : 0
Probe : CB1_FCC_EFS_1-18G-1_0901 - HORIZONTAL	Power : AC 230V/50Hz
EUT : Printer	Note : Mode 7: Documents Printing (72W)

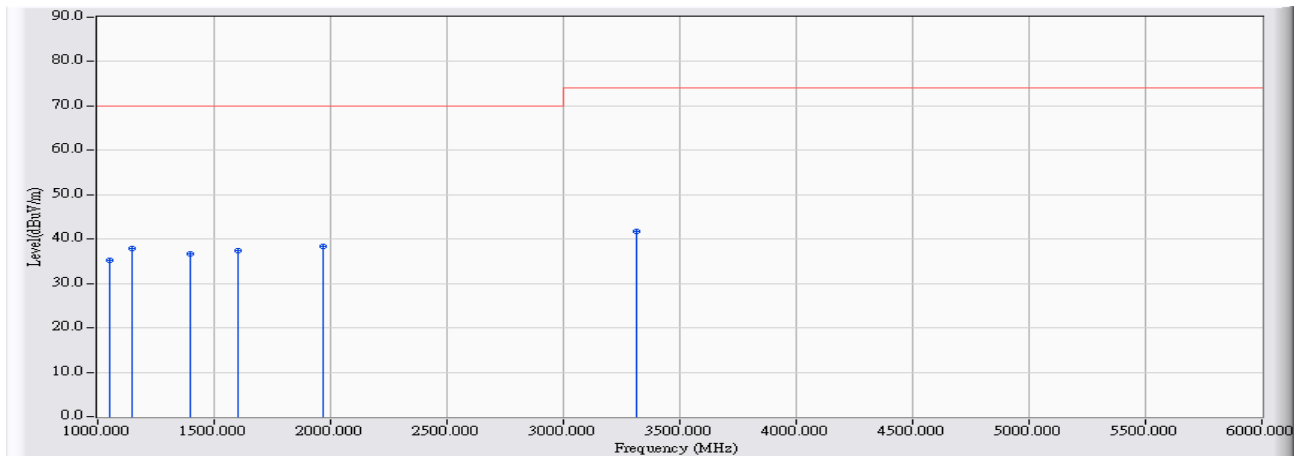

	Frequency (MHz)	Correct Factor (dB)	Reading Level (dBuV)	Measure Level (dBuV/m)	Margin (dB)	Limit (dBuV/m)	Detector Type
1	1050.000	-17.933	53.070	35.137	-34.863	70.000	PEAK
2	1150.000	-17.736	55.580	37.844	-32.156	70.000	PEAK
3	1396.000	-17.141	53.800	36.659	-33.341	70.000	PEAK
4	1600.000	-16.756	54.160	37.404	-32.596	70.000	PEAK
5	* 1968.000	-16.343	54.810	38.467	-31.533	70.000	PEAK
6	3314.000	-13.025	54.850	41.824	-32.176	74.000	PEAK

Note:

1. All Readings below 1GHz are Quasi-Peak, above are performed with peak and/or average measurements as necessary.
2. “ * ”, means this data is the worst emission level.
3. Measurement Level = Reading Level + Correct Factor
4. The average measurement was not performed when the peak measured data under the limit of average detection. If the readings given are average, peak measurement should also be supplied.

Site : SITE3	Time : 2015/11/30 - 15:03
Limit : CISPR_B_10M_QP	Margin : 6
Probe : Site3_10M-3_0426 - VERTICAL	Power : AC 230V/50Hz
EUT : Printer	Note : Mode 7: Documents Printing (72W)

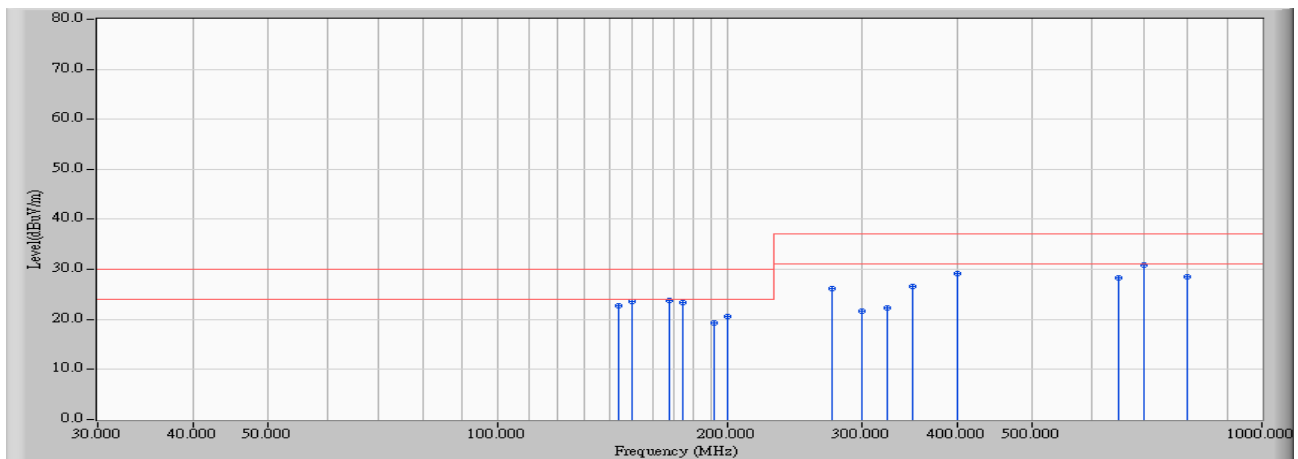

	Frequency (MHz)	Correct Factor (dB)	Reading Level (dBuV)	Measure Level (dBuV/m)	Margin (dB)	Limit (dBuV/m)	Detector Type
1	143.850	14.610	8.110	22.720	-7.280	30.000	QUASPEAK
2	150.000	14.292	9.370	23.662	-6.338	30.000	QUASPEAK
3	168.000	13.798	9.950	23.748	-6.252	30.000	QUASPEAK
4	175.000	13.715	9.680	23.395	-6.605	30.000	QUASPEAK
5	192.000	12.138	7.120	19.258	-10.742	30.000	QUASPEAK
6	200.000	11.402	9.180	20.582	-9.418	30.000	QUASPEAK
7	274.000	17.468	8.620	26.088	-10.912	37.000	QUASPEAK
8	300.000	16.532	5.060	21.592	-15.408	37.000	QUASPEAK
9	323.750	17.505	4.840	22.345	-14.655	37.000	QUASPEAK
10	348.700	21.040	5.540	26.580	-10.420	37.000	QUASPEAK
11	400.000	22.498	6.610	29.108	-7.892	37.000	QUASPEAK
12	650.000	26.040	2.240	28.280	-8.720	37.000	QUASPEAK
13	* 700.000	29.331	1.450	30.781	-6.219	37.000	QUASPEAK
14	800.000	26.600	1.970	28.570	-8.430	37.000	QUASPEAK

Note:

1. All Reading Levels are Quasi-Peak value.
2. “ * ”, means this data is the worst emission level.
3. Measurement Level = Reading Level + Correct Factor.

Site : CB1	Time : 2016/04/11 - 10:00
Limit : CISPR_22_B_(Above_1G)_3M_PK	Margin : 0
Probe : CB1_FCC_EFS_1-18G-1_0901 - VERTICAL	Power : AC 230V/50Hz
EUT : Printer	Note : Mode 7: Documents Printing (72W)

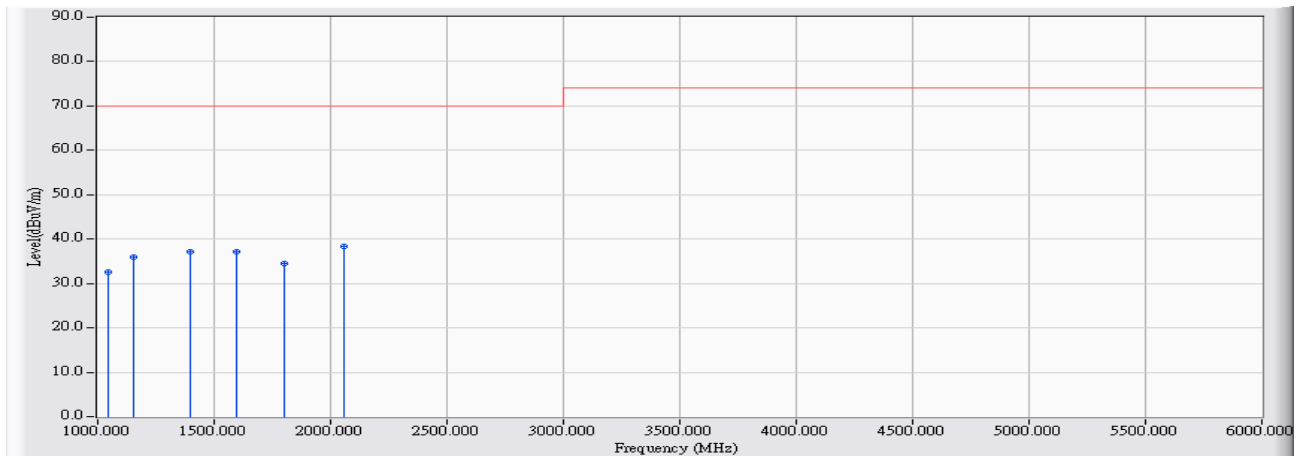

	Frequency (MHz)	Correct Factor (dB)	Reading Level (dBuV)	Measure Level (dBuV/m)	Margin (dB)	Limit (dBuV/m)	Detector Type
1	1045.000	-17.942	50.560	32.618	-37.382	70.000	PEAK
2	1152.000	-17.730	53.640	35.909	-34.091	70.000	PEAK
3	1400.000	-17.131	54.230	37.099	-32.901	70.000	PEAK
4	1595.000	-16.762	54.020	37.258	-32.742	70.000	PEAK
5	1799.000	-16.522	50.970	34.448	-35.552	70.000	PEAK
6	* 2058.000	-16.138	54.530	38.392	-31.608	70.000	PEAK

Note:

1. All Readings below 1GHz are Quasi-Peak, above are performed with peak and/or average measurements as necessary.
2. “ * ”, means this data is the worst emission level.
3. Measurement Level = Reading Level + Correct Factor
4. The average measurement was not performed when the peak measured data under the limit of average detection. If the readings given are average, peak measurement should also be supplied.

Site : SITE3	Time : 2016/04/15 - 13:03
Limit : CISPR_B_10M_QP	Margin : 6
Probe : Site3_10M-3_0426 - HORIZONTAL	Power : AC 230V/50Hz
EUT : Printer	Note : Mode 8: WiFi Printing (72W)

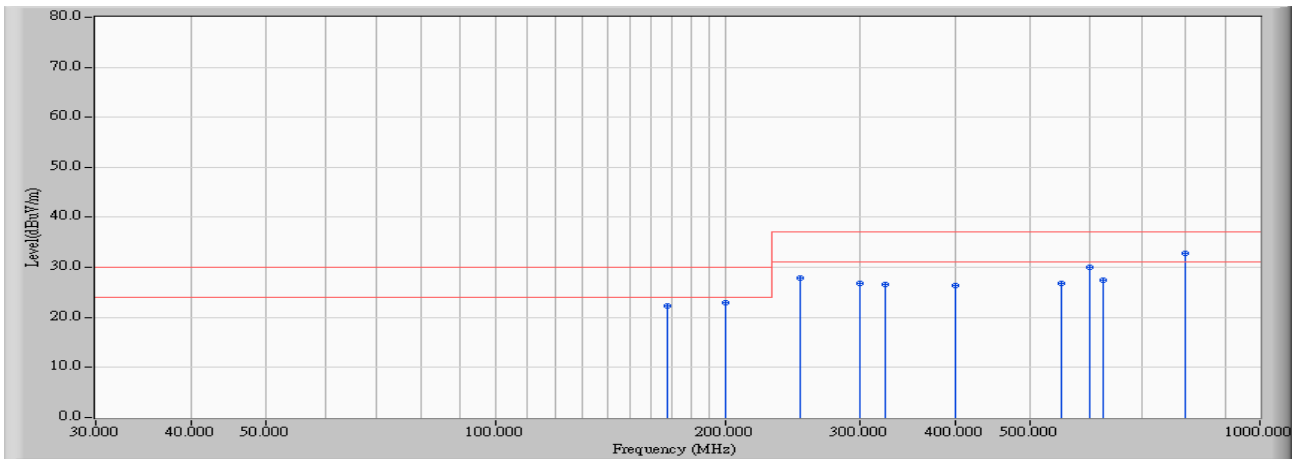

		Frequency (MHz)	Correct Factor (dB)	Reading Level (dBuV)	Measure Level (dBuV/m)	Margin (dB)	Limit (dBuV/m)	Detector Type
1		168.000	11.934	10.310	22.244	-7.756	30.000	QUASPEAK
2		200.000	11.881	11.170	23.051	-6.949	30.000	QUASPEAK
3		250.000	17.252	10.550	27.802	-9.198	37.000	QUASPEAK
4		300.000	18.644	8.270	26.914	-10.086	37.000	QUASPEAK
5		323.800	19.112	7.570	26.681	-10.319	37.000	QUASPEAK
6		400.000	21.726	4.650	26.376	-10.624	37.000	QUASPEAK
7		550.000	24.107	2.670	26.777	-10.223	37.000	QUASPEAK
8		600.000	25.972	4.050	30.023	-6.977	37.000	QUASPEAK
9		625.000	25.195	2.300	27.495	-9.505	37.000	QUASPEAK
10	*	800.000	30.914	1.810	32.724	-4.276	37.000	QUASPEAK

Note:

1. All Reading Levels are Quasi-Peak value.
2. “ * ”, means this data is the worst emission level.
3. Measurement Level = Reading Level + Correct Factor.

Site : CB1	Time : 2016/04/11 - 10:00
Limit : CISPR_22_B_(Above_1G)_3M_PK	Margin : 0
Probe : CB1_FCC_EFS_1-18G-1_0901 - HORIZONTAL	Power : AC 230V/50Hz
EUT : Printer	Note : Mode 8: WiFi Printing (72W)

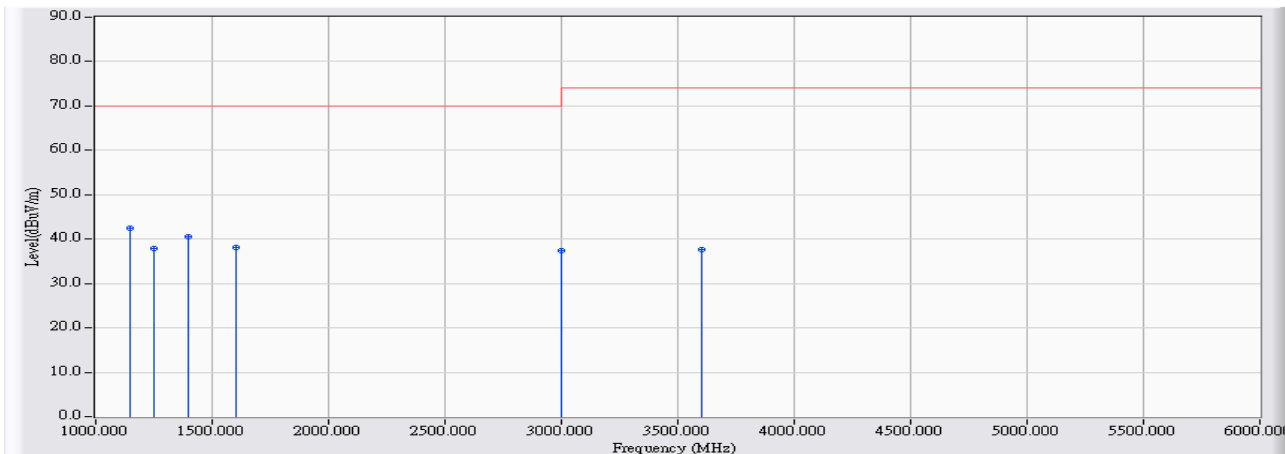

		Frequency (MHz)	Correct Factor (dB)	Reading Level (dBuV)	Measure Level (dBuV/m)	Margin (dB)	Limit (dBuV/m)	Detector Type
1	*	1145.000	-17.746	60.300	42.554	-27.446	70.000	PEAK
2		1252.000	-17.498	55.260	37.762	-32.238	70.000	PEAK
3		1396.000	-17.141	57.660	40.519	-29.481	70.000	PEAK
4		1600.000	-16.756	54.880	38.124	-31.876	70.000	PEAK
5		3000.000	-13.391	50.730	37.339	-32.661	70.000	PEAK
6		3600.000	-12.536	50.110	37.573	-36.427	74.000	PEAK

Note:

1. All Readings below 1GHz are Quasi-Peak, above are performed with peak and/or average measurements as necessary.
2. “ * ”, means this data is the worst emission level.
3. Measurement Level = Reading Level + Correct Factor
4. The average measurement was not performed when the peak measured data under the limit of average detection. If the readings given are average, peak measurement should also be supplied.

Site : SITE3	Time : 2016/04/15 - 13:03
Limit : CISPR_B_10M_QP	Margin : 6
Probe : Site3_10M-3_0426 - VERTICAL	Power : AC 230V/50Hz
EUT : Printer	Note : Mode 8: WiFi Printing (72W)

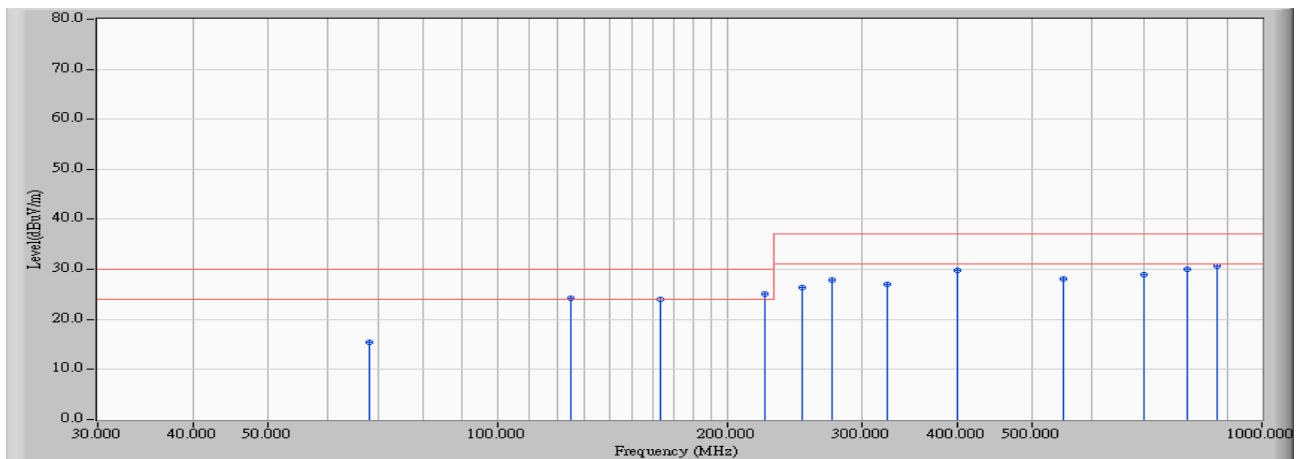

	Frequency (MHz)	Correct Factor (dB)	Reading Level (dBuV)	Measure Level (dBuV/m)	Margin (dB)	Limit (dBuV/m)	Detector Type
1	67.890	8.148	7.200	15.348	-14.652	30.000	QUASIPeAK
2	124.525	13.474	10.730	24.204	-5.796	30.000	QUASIPeAK
3	163.550	14.757	9.240	23.998	-6.002	30.000	QUASIPeAK
4	* 224.175	16.241	8.900	25.141	-4.859	30.000	QUASIPeAK
5	250.000	14.990	11.410	26.401	-10.599	37.000	QUASIPeAK
6	274.000	17.468	10.320	27.788	-9.212	37.000	QUASIPeAK
7	323.825	17.511	9.590	27.100	-9.900	37.000	QUASIPeAK
8	400.000	22.498	7.310	29.808	-7.192	37.000	QUASIPeAK
9	550.000	27.632	0.430	28.062	-8.938	37.000	QUASIPeAK
10	700.000	29.331	-0.270	29.061	-7.939	37.000	QUASIPeAK
11	800.000	26.600	3.350	29.950	-7.050	37.000	QUASIPeAK
12	875.000	29.250	1.500	30.750	-6.250	37.000	QUASIPeAK

Note:

1. All Reading Levels are Quasi-Peak value.
2. “ * ”, means this data is the worst emission level.
3. Measurement Level = Reading Level + Correct Factor.

Site : CB1	Time : 2016/04/11 - 10:00
Limit : CISPR_22_B_(Above_1G)_3M_PK	Margin : 0
Probe : CB1_FCC_EFS_1-18G-1_0901 - VERTICAL	Power : AC 230V/50Hz
EUT : Printer	Note : Mode 8: WiFi Printing (72W)

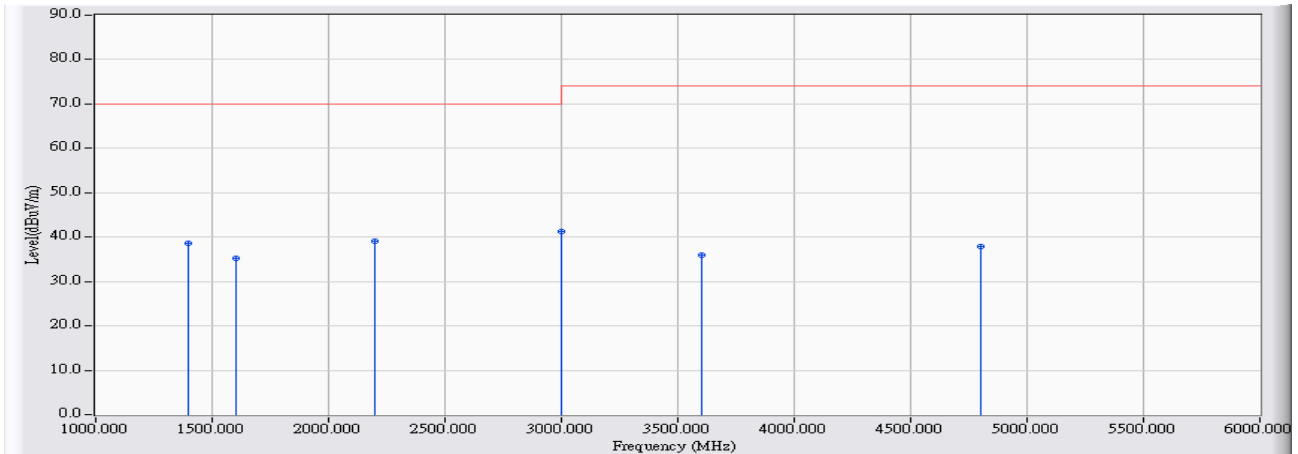

	Frequency (MHz)	Correct Factor (dB)	Reading Level (dBuV)	Measure Level (dBuV/m)	Margin (dB)	Limit (dBuV/m)	Detector Type
1	1400.000	-17.131	55.840	38.709	-31.291	70.000	PEAK
2	1600.000	-16.756	52.000	35.244	-34.756	70.000	PEAK
3	2200.000	-15.717	54.840	39.123	-30.877	70.000	PEAK
4	* 3000.000	-13.391	54.640	41.249	-28.751	70.000	PEAK
5	3600.000	-12.536	48.470	35.933	-38.067	74.000	PEAK
6	4800.000	-9.526	47.410	37.884	-36.116	74.000	PEAK

Note:

1. All Readings below 1GHz are Quasi-Peak, above are performed with peak and/or average measurements as necessary.
2. “ * ”, means this data is the worst emission level.
3. Measurement Level = Reading Level + Correct Factor
4. The average measurement was not performed when the peak measured data under the limit of average detection. If the readings given are average, peak measurement should also be supplied.

5.7. Test Photograph

Test Mode : Mode 1: PC Printing (110W)

Description : Front View of Radiated Emissions Test Setup



Test Mode : Mode 1: PC Printing (110W)

Description : Back View of Radiated Emissions Test Setup



Test Mode : Mode 1: PC Printing (110W)

Description : Front View of Radiated Emissions Test Setup (Horn)



Test Mode : Mode 1: PC Printing (110W)

Description : Back View of Radiated Emissions Test Setup (Horn)



Test Mode : Mode 2: LAN Printing (110W)

Description : Front View of Radiated Emissions Test Setup



Test Mode : Mode 2: LAN Printing (110W)

Description : Back View of Radiated Emissions Test Setup



Test Mode : Mode 2: LAN Printing (110W)

Description : Front View of Radiated Emissions Test Setup (Horn)

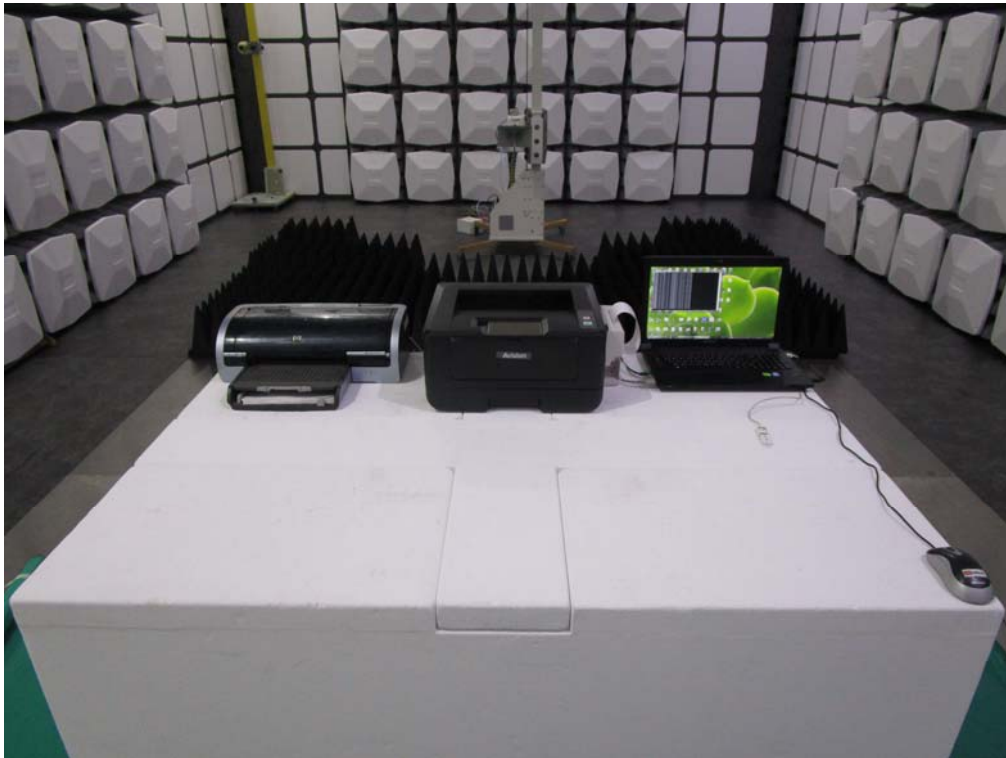

Test Mode : Mode 2: LAN Printing (110W)

Description : Back View of Radiated Emissions Test Setup (Horn)

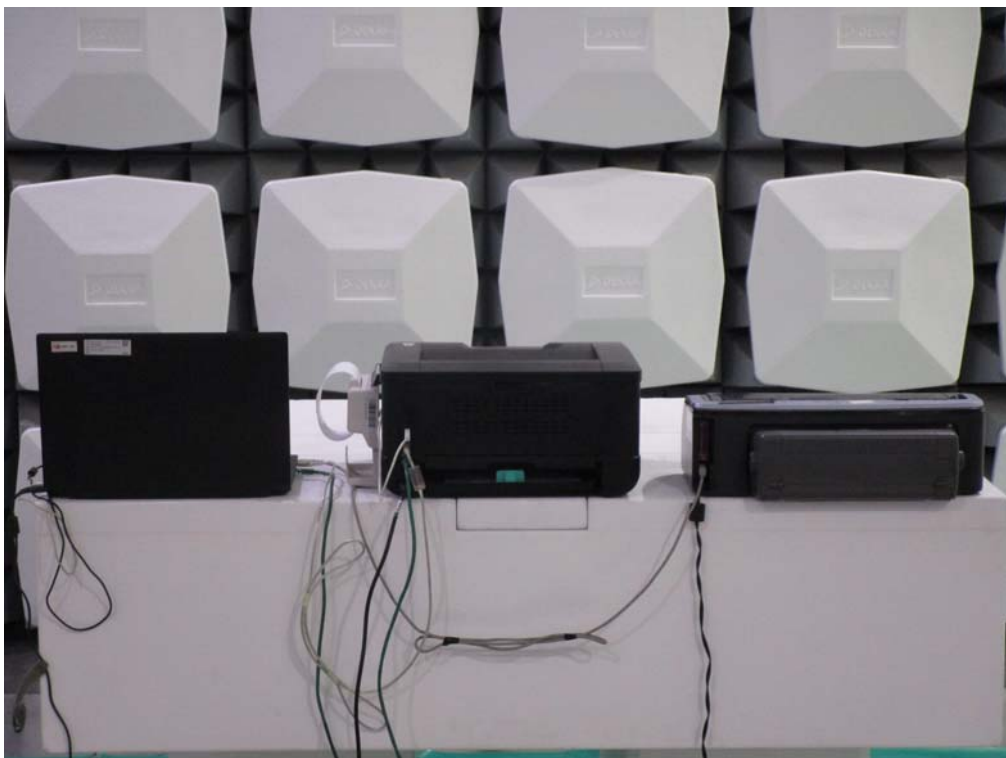

Test Mode : Mode 3: Document Printing (110W)

Description : Front View of Radiated Emissions Test Setup



Test Mode : Mode 3: Document Printing (110W)

Description : Back View of Radiated Emissions Test Setup



Test Mode : Mode 3: Document Printing (110W)

Description : Front View of Radiated Emissions Test Setup (Horn)



Test Mode : Mode 3: Document Printing (110W)

Description : Back View of Radiated Emissions Test Setup (Horn)



Test Mode : Mode 4: WiFi Printing (110W)

Description : Front View of Radiated Emissions Test Setup



Test Mode : Mode 4: WiFi Printing (110W)

Description : Back View of Radiated Emissions Test Setup



Test Mode : Mode 4: WiFi Printing (110W)

Description : Front View of Radiated Emissions Test Setup (Horn)



Test Mode : Mode 4: WiFi Printing (110W)

Description : Back View of Radiated Emissions Test Setup (Horn)

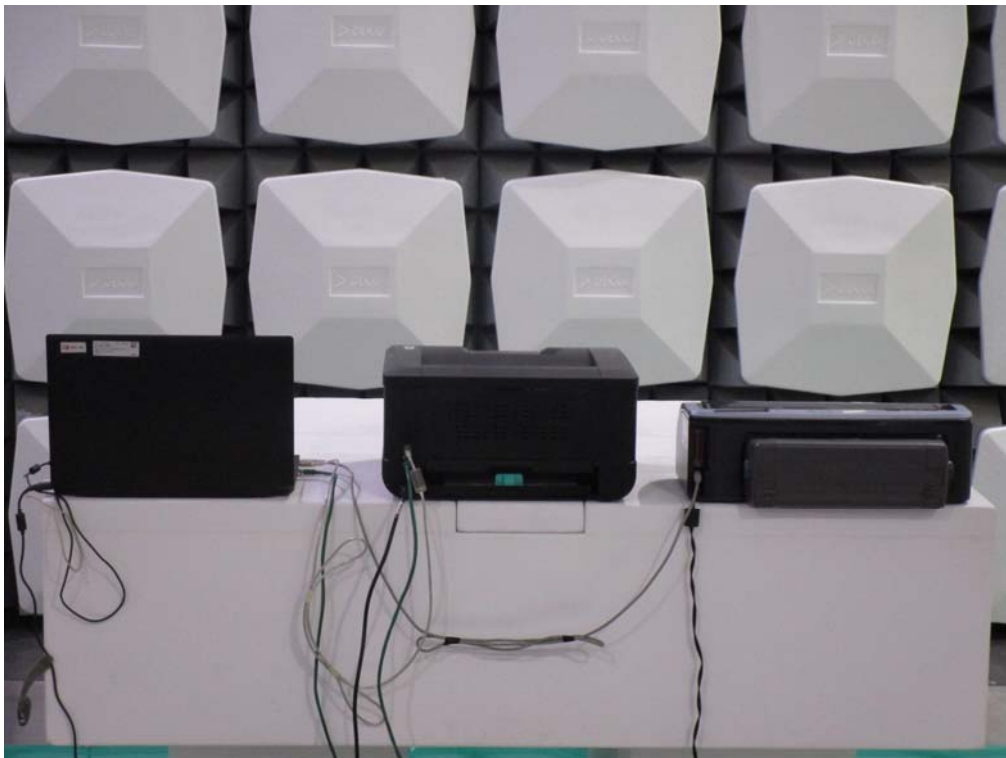

Test Mode : Mode 5: PC Printing (72W)

Description : Front View of Radiated Emissions Test Setup



Test Mode : Mode 5: PC Printing (72W)

Description : Back View of Radiated Emissions Test Setup



Test Mode : Mode 5: PC Printing (72W)

Description : Front View of Radiated Emissions Test Setup (Horn)



Test Mode : Mode 5: PC Printing (72W)

Description : Back View of Radiated Emissions Test Setup (Horn)



Test Mode : Mode 6: LAN Printing (72W)

Description : Front View of Radiated Emissions Test Setup



Test Mode : Mode 6: LAN Printing (72W)

Description : Back View of Radiated Emissions Test Setup



Test Mode : Mode 6: LAN Printing (72W)

Description : Front View of Radiated Emissions Test Setup (Horn)

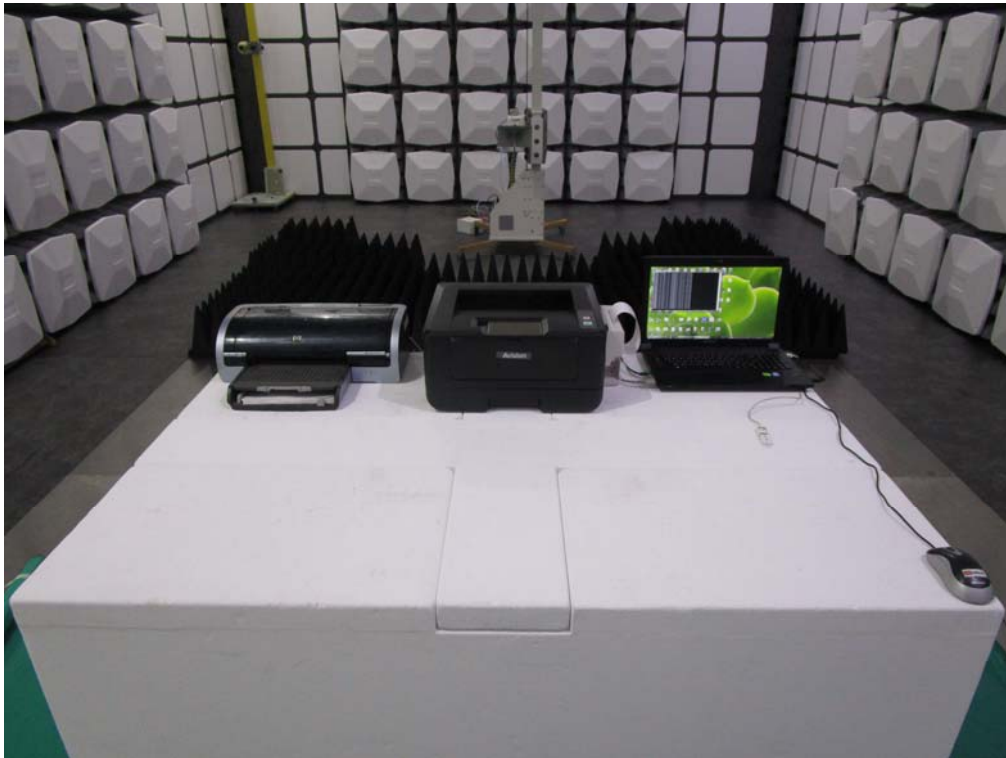

Test Mode : Mode 6: LAN Printing (72W)

Description : Back View of Radiated Emissions Test Setup (Horn)

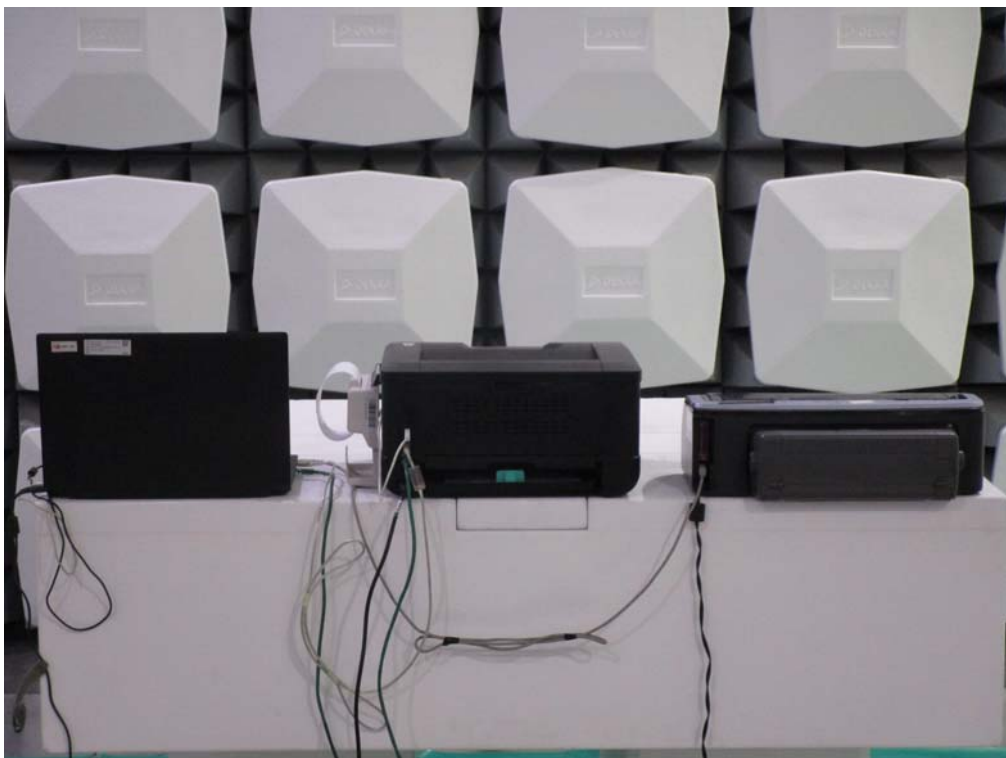

Test Mode : Mode 7: Document Printing (72W)

Description : Front View of Radiated Emissions Test Setup



Test Mode : Mode 7: Document Printing (72W)

Description : Back View of Radiated Emissions Test Setup



Test Mode : Mode 7: Document Printing (72W)

Description : Front View of Radiated Emissions Test Setup (Horn)



Test Mode : Mode 7: Document Printing (72W)

Description : Back View of Radiated Emissions Test Setup (Horn)



Test Mode : Mode 8: WiFi Printing (72W)

Description : Front View of Radiated Emissions Test Setup



Test Mode : Mode 8: WiFi Printing (72W)

Description : Back View of Radiated Emissions Test Setup



Test Mode : Mode 8: WiFi Printing (72W)

Description : Front View of Radiated Emissions Test Setup (Horn)



Test Mode : Mode 8: WiFi Printing (72W)

Description : Back View of Radiated Emissions Test Setup (Horn)

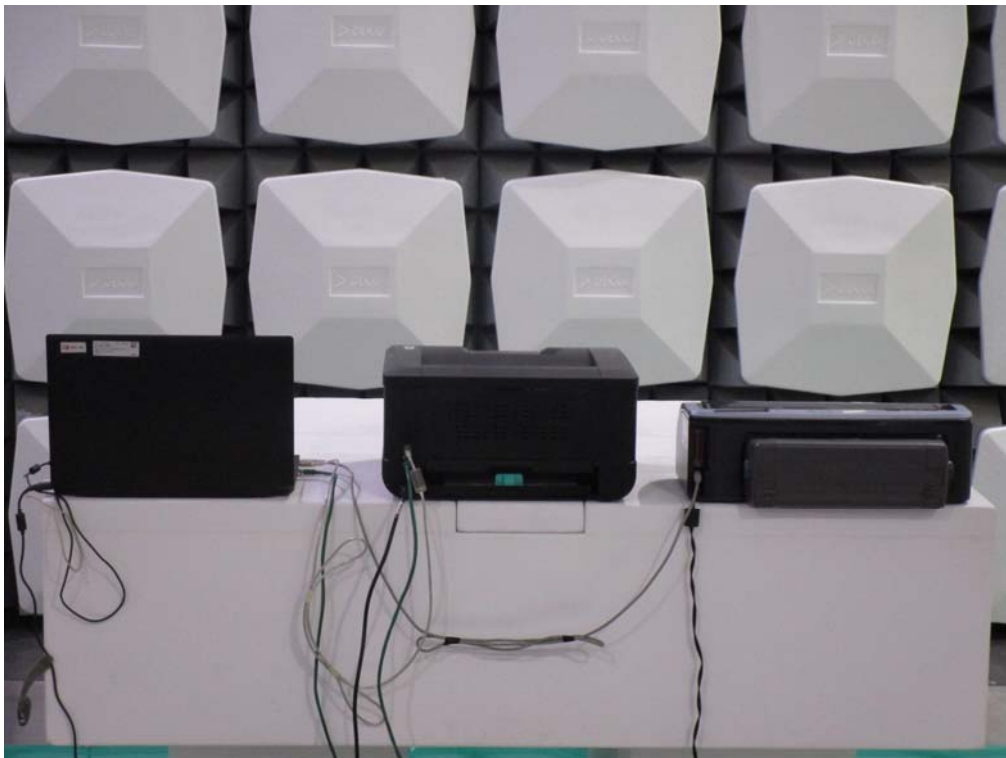

6. Harmonic Current Emission

6.1. Test Specification

According to EMC Standard : EN 61000-3-2

6.2. Test Setup

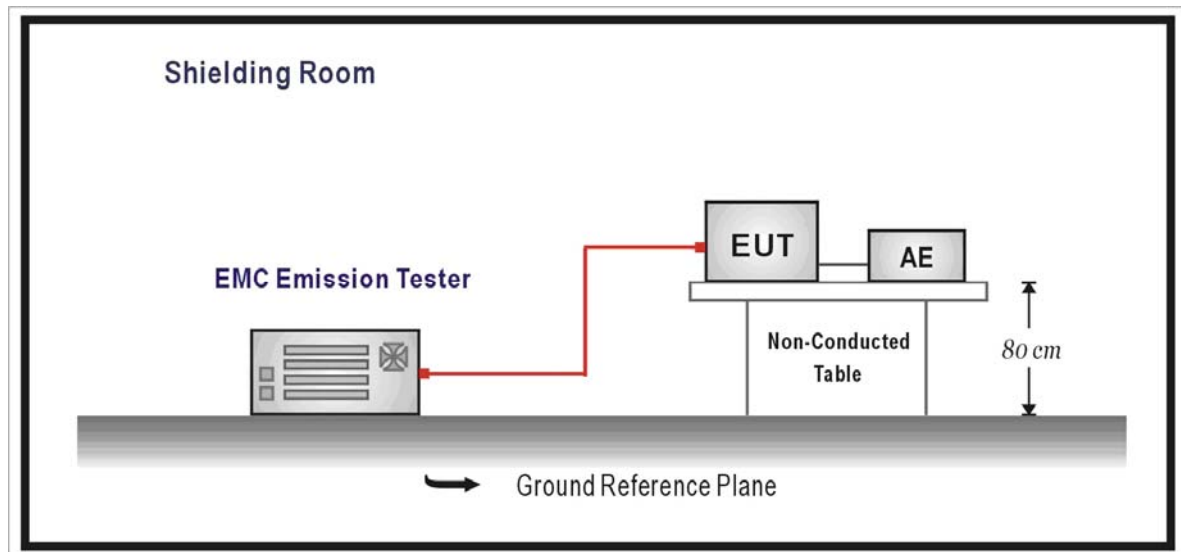

6.3. Limit

(a) Limits of Class A Harmonics Currents

Harmonics Order n	Maximum Permissible harmonic current A	Harmonics Order n	Maximum Permissible harmonic current A
Odd harmonics		Even harmonics	
3	2.30	2	1.08
5	1.14	4	0.43
7	0.77	6	0.30
9	0.40	8 ≤ n ≤ 40	0.23 * 8/n
11	0.33		
13	0.21		
15 ≤ n ≤ 39	0.15 * 15/n		

(b) Limits of Class B Harmonics Currents

For Class B equipment, the harmonic of the input current shall not exceed the maximum permissible values given in table that is the limit of Class A multiplied by a factor of 1.5.

(c) Limits of Class C Harmonics Currents

Harmonics Order n	Maximum Permissible harmonic current Expressed as a percentage of the input current at the fundamental frequency %
2	2
3	30. λ^*
5	10
7	7
9	5
$11 \leq n \leq 39$ (odd harmonics only)	3

* λ is the circuit power factor

(d) Limits of Class D Harmonics Currents

Harmonics Order n	Maximum Permissible harmonic current per watt mA/W	Maximum Permissible harmonic current A
3	3.4	2.30
5	1.9	1.14
7	1.0	0.77
9	0.5	0.40
11	0.35	0.33
$11 \leq n \leq 39$ (odd harmonics only)	3.85/n	See limit of Class A

6.4. Test Procedure

The EUT is supplied in series with power analyzer from a power source having the same normal voltage and frequency as the rated supply voltage and the equipment under test. And the rated voltage at the supply voltage of EUT of 0.94 times and 1.06 times shall be performed.

6.5. Deviation from Test Standard

No deviation.

6.6. Test Result

Product	Printer		
Test Item	Power Harmonics		
Test Mode	Mode 1: PC Printing (110W)		
Date of Test	2016/04/01	Test Site	SR1

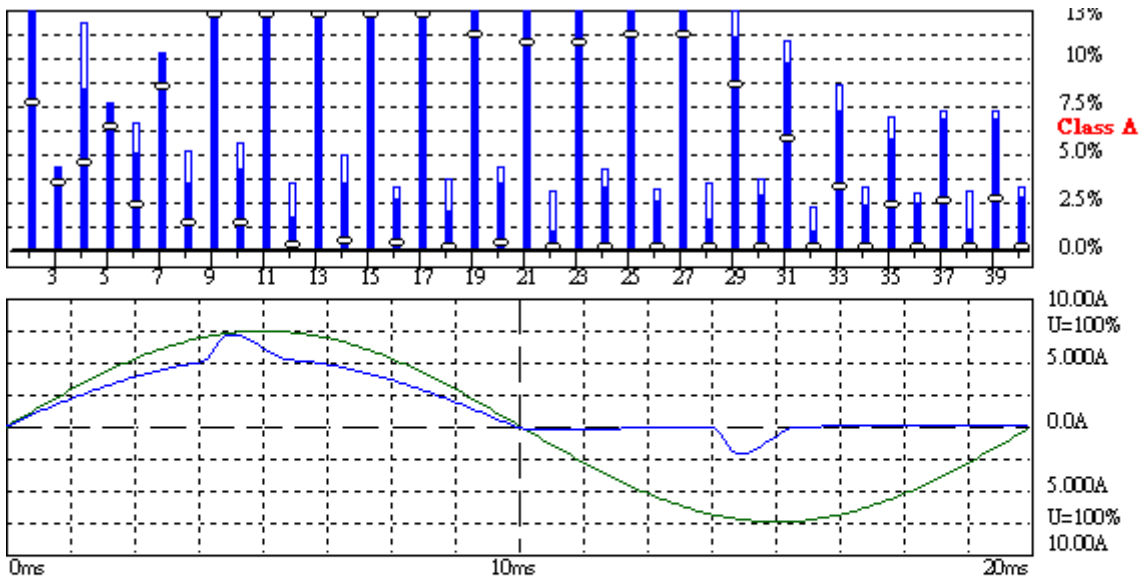

Harmonic Emission - IEC 61000-3-2 , EN 61000-3-2 , (EN60555-2)

2016/4/1 下午 04:12:

U_{rms} = 230.1 V P = 491.3 W THC = 0.557 A
 I_{rms} = 2.866 A pf = 0.745

Range: 10 A
 V_{nom}: 230 V
 TestTime: 5 min (100%)

Test completed, Result: PASSED

BAR-1000 EMC-Printer

Full Bar : Actual Values

Empty Bar : Maximum Values

Blue : Current , Green : Voltage , Red : Failed

Urms = 230.1V Freq = 50.000 Range: 10 A
 Irms = 2.866A Ipk = 7.261A cf = 2.533
 P = 491.3W S = 659.5VA pf = 0.745
 THDi = 20.9 % THDu = 0.10 % Class A

Test - Time : 5min (100 %)

Test completed, Result: PASSED

Order	Freq. [Hz]	Iavg [A]	Iavg%L [%]	Imax [A]	Imax%L [%]	Limit [A]	Status
1	50	1.4435		6.6791			
2	100	0.2043	18.917	0.4968	46.002	1.0800	
3	150	0.1989	8.6464	0.2429	10.562	2.3000	
4	200	0.0473	11.005	0.1270	29.524	0.4300	
5	250	0.1801	15.794	0.2179	19.114	1.1400	
6	300	0.0173	5.7702	0.0488	16.276	0.3000	
7	350	0.1625	21.108	0.1959	25.445	0.7700	
8	400	0.0075	3.2570	0.0287	12.472	0.2300	
9	450	0.1376	34.394	0.1672	41.809	0.4000	
10	500	0.0064	3.4638	0.0250	13.600	0.1840	
11	550	0.1130	34.233	0.1373	41.615	0.3300	
12	600	0.0004	0.2801	0.0128	8.3592	0.1533	
13	650	0.0869	41.396	0.1068	50.863	0.2100	
14	700	0.0014	1.0616	0.0159	12.074	0.1314	
15	750	0.0637	42.483	0.0800	53.304	0.1500	
16	800	0.0005	0.4363	0.0092	7.9611	0.1150	
17	850	0.0458	34.602	0.0580	43.810	0.1324	
18	900	0.0001	0.0829	0.0092	8.9562	0.1022	
19	950	0.0329	27.756	0.0421	35.563	0.1184	
20	1000	0.0006	0.6543	0.0098	10.615	0.0920	
21	1050	0.0285	26.611	0.0348	32.471	0.1071	
22	1100	0.0000	0.0000	0.0061	7.2977	0.0836	
23	1150	0.0265	27.075	0.0330	33.691	0.0978	
24	1200	0.0002	0.3172	0.0079	10.349	0.0767	
25	1250	0.0252	27.954	0.0317	35.265	0.0900	
26	1300	0.0000	0.0000	0.0055	7.7621	0.0708	
27	1350	0.0231	27.777	0.0299	35.889	0.0833	
28	1400	0.0000	0.0000	0.0055	8.3592	0.0657	
29	1450	0.0166	21.345	0.0244	31.467	0.0776	
30	1500	0.0000	0.0183	0.0055	8.9562	0.0613	
31	1550	0.0101	13.893	0.0195	26.910	0.0726	
32	1600	0.0000	0.0000	0.0031	5.3074	0.0575	
33	1650	0.0056	8.2087	0.0146	21.484	0.0682	
34	1700	0.0000	0.0000	0.0043	7.8948	0.0541	
35	1750	0.0038	5.9778	0.0110	17.090	0.0643	
36	1800	0.0000	0.0000	0.0037	7.1650	0.0511	
37	1850	0.0035	5.8147	0.0110	18.066	0.0608	
38	1900	0.0000	0.0000	0.0037	7.5631	0.0484	
39	1950	0.0034	5.9213	0.0104	17.985	0.0577	
40	2000	0.0000	0.0000	0.0037	7.9611	0.0460	

Product	Printer		
Test Item	Power Harmonics		
Test Mode	Mode 2: LAN Printing (110W)		
Date of Test	2016/01/06	Test Site	SR1

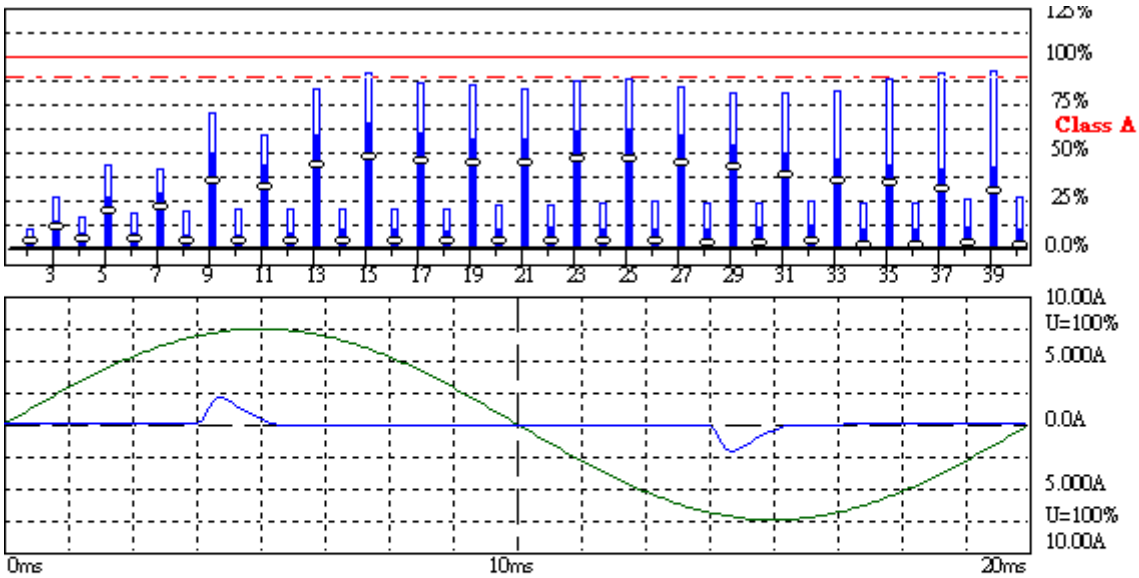

Harmonic Emission - IEC 61000-3-2 , EN 61000-3-2 , (EN60555-2)

2016/1/6 上午 11:52:

U_{rms} = 230.1 V P = 53.01 W THC = 0.688 A
 I_{rms} = 0.508 A pf = 0.454

Range: 10 A
 V-nom: 230 V
 TestTime: 5 min (100%)

Test completed, Result: PASSED

HAR-1000 EMC-Return

- Full Bar : Actual Values
- Empty Bar : Maximum Values
- Blue : Current , Green : Voltage , Red : Failed

Urms = 230.1V Freq = 49.987 Range: 10 A
 Irms = 0.508A Ipk = 2.212A cf = 4.356
 P = 53.01W S = 116.9VA pf = 0.454
 THDi = 35.7 % THDu = 0.10 % Class A

Test - Time : 5min (100 %)

Test completed, Result: PASSED

Order	Freq. [Hz]	Iavg [A]	Iavg%L [%]	Imax [A]	Imax%L [%]	Limit [A]	Status
1	50	1.1318		6.1707			
2	100	0.0289	2.6716	0.1013	9.3813	1.0800	
3	150	0.2249	9.7796	0.6042	26.272	2.3000	
4	200	0.0149	3.4554	0.0665	15.472	0.4300	
5	250	0.2107	18.484	0.4877	42.778	1.1400	
6	300	0.0100	3.3179	0.0525	17.497	0.3000	
7	350	0.1526	19.821	0.3088	40.109	0.7700	
8	400	0.0064	2.7696	0.0421	18.311	0.2300	
9	450	0.1384	34.601	0.2783	69.580	0.4000	
10	500	0.0045	2.4596	0.0354	19.239	0.1840	
11	550	0.1031	31.253	0.1904	57.706	0.3300	
12	600	0.0039	2.5562	0.0299	19.505	0.1533	
13	650	0.0897	42.709	0.1721	81.961	0.2100	
14	700	0.0034	2.5761	0.0256	19.505	0.1314	
15	750	0.0711	47.381	0.1355	90.332	0.1500	
16	800	0.0028	2.4243	0.0220	19.107	0.1150	
17	850	0.0595	44.945	0.1135	85.775	0.1324	
18	900	0.0022	2.1934	0.0195	19.107	0.1022	
19	950	0.0513	43.343	0.0989	83.496	0.1184	
20	1000	0.0023	2.4951	0.0189	20.566	0.0920	
21	1050	0.0463	43.259	0.0885	82.601	0.1071	
22	1100	0.0021	2.5567	0.0183	21.893	0.0836	
23	1150	0.0442	45.164	0.0842	86.100	0.0978	
24	1200	0.0019	2.4634	0.0171	22.291	0.0767	
25	1250	0.0407	45.193	0.0781	86.806	0.0900	
26	1300	0.0016	2.3217	0.0165	23.286	0.0708	
27	1350	0.0365	43.746	0.0696	83.496	0.0833	
28	1400	0.0014	2.0914	0.0146	22.291	0.0657	
29	1450	0.0315	40.658	0.0623	80.241	0.0776	
30	1500	0.0013	2.0681	0.0140	22.888	0.0613	
31	1550	0.0270	37.195	0.0580	79.888	0.0726	
32	1600	0.0010	1.7093	0.0134	23.353	0.0575	
33	1650	0.0234	34.286	0.0555	81.462	0.0682	
34	1700	0.0007	1.2847	0.0122	22.556	0.0541	
35	1750	0.0205	31.853	0.0555	86.399	0.0643	
36	1800	0.0005	0.8853	0.0116	22.689	0.0511	
37	1850	0.0185	30.490	0.0549	90.332	0.0608	
38	1900	0.0004	0.7664	0.0116	23.950	0.0484	
39	1950	0.0164	28.495	0.0531	92.041	0.0577	
40	2000	0.0003	0.6192	0.0116	25.210	0.0460	

Product	Printer		
Test Item	Power Harmonics		
Test Mode	Mode 3: Document Printing (110W)		
Date of Test	2015/12/16	Test Site	SR1

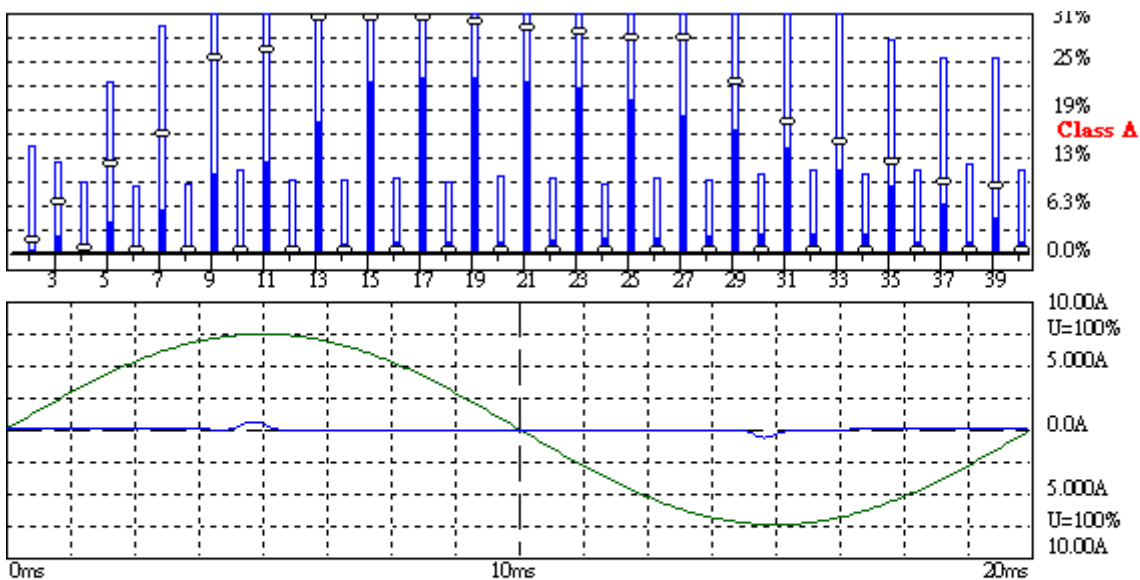

Harmonic Emission - IEC 61000-3-2 , EN 61000-3-2 , (EN60555-2)

2015/12/16 上午 09:4

U_{rms} = 230.1 V P = 12.27 W THC = 0.120 A
 I_{rms} = 0.151 A pf = 0.352

Range: 10 A
 V-nom: 230 V
 TestTime: 5 min (100%)

Test completed, Result: PASSED

HAR-1000 EMC-Retour

Full Bar : Actual Values
 Empty Bar : Maximum Values
 Blue : Current , Green : Voltage , Red : Failed

Urms = 230.1V Freq = 50.000 Range: 10 A
 Irms = 0.151A Ipk = 0.737A cf = 4.871
 P = 12.27W S = 34.83VA pf = 0.352
 THDi = 142 % THDu = 0.10 % Class A

Test - Time : 5min (100 %)

Test completed, Result: PASSED

Order	Freq. [Hz]	Iavg [A]	Iavg%L [%]	Imax [A]	Imax%L [%]	Limit [A]	Status
1	50	0.8816		9.3085			
2	100	0.0163	1.5073	0.1477	13.676	1.0800	
3	150	0.1432	6.2264	0.2716	11.809	2.3000	
4	200	0.0017	0.4057	0.0391	9.0843	0.4300	
5	250	0.1278	11.209	0.2533	22.219	1.1400	
6	300	0.0007	0.2374	0.0256	8.5449	0.3000	
7	350	0.1172	15.221	0.2277	29.566	0.7700	
8	400	0.0003	0.1313	0.0201	8.7572	0.2300	
9	450	0.1012	25.295	0.1965	49.133	0.4000	
10	500	0.0002	0.1256	0.0195	10.615	0.1840	
11	550	0.0863	26.140	0.1630	49.383	0.3300	
12	600	0.0002	0.1255	0.0140	9.1553	0.1533	
13	650	0.0702	33.430	0.1300	61.907	0.2100	
14	700	0.0001	0.1074	0.0122	9.2880	0.1314	
15	750	0.0553	36.865	0.1007	67.139	0.1500	
16	800	0.0001	0.1234	0.0110	9.5533	0.1150	
17	850	0.0448	33.855	0.0781	59.028	0.1324	
18	900	0.0001	0.1024	0.0092	8.9562	0.1022	
19	950	0.0353	29.837	0.0629	53.087	0.1184	
20	1000	0.0001	0.0741	0.0092	9.9514	0.0920	
21	1050	0.0311	29.048	0.0543	50.700	0.1071	
22	1100	0.0001	0.0613	0.0079	9.4870	0.0836	
23	1150	0.0283	28.978	0.0494	50.537	0.0978	
24	1200	0.0000	0.0495	0.0067	8.7572	0.0767	
25	1250	0.0249	27.682	0.0452	50.184	0.0900	
26	1300	0.0000	0.0437	0.0067	9.4870	0.0708	
27	1350	0.0233	27.921	0.0397	47.607	0.0833	
28	1400	0.0000	0.0363	0.0061	9.2880	0.0657	
29	1450	0.0169	21.756	0.0336	43.267	0.0776	
30	1500	0.0000	0.0286	0.0061	9.9514	0.0613	
31	1550	0.0125	17.181	0.0269	37.001	0.0726	
32	1600	0.0000	0.0305	0.0061	10.615	0.0575	
33	1650	0.0097	14.229	0.0214	31.331	0.0682	
34	1700	0.0000	0.0208	0.0055	10.150	0.0541	
35	1750	0.0073	11.340	0.0177	27.534	0.0643	
36	1800	0.0000	0.0330	0.0055	10.747	0.0511	
37	1850	0.0055	8.9662	0.0153	25.092	0.0608	
38	1900	0.0000	0.0116	0.0055	11.345	0.0484	
39	1950	0.0048	8.3601	0.0146	25.391	0.0577	
40	2000	0.0000	0.0000	0.0049	10.615	0.0460	

Product	Printer		
Test Item	Power Harmonics		
Test Mode	Mode 4: WiFi Printing (110W)		
Date of Test	2016/04/01	Test Site	SR1

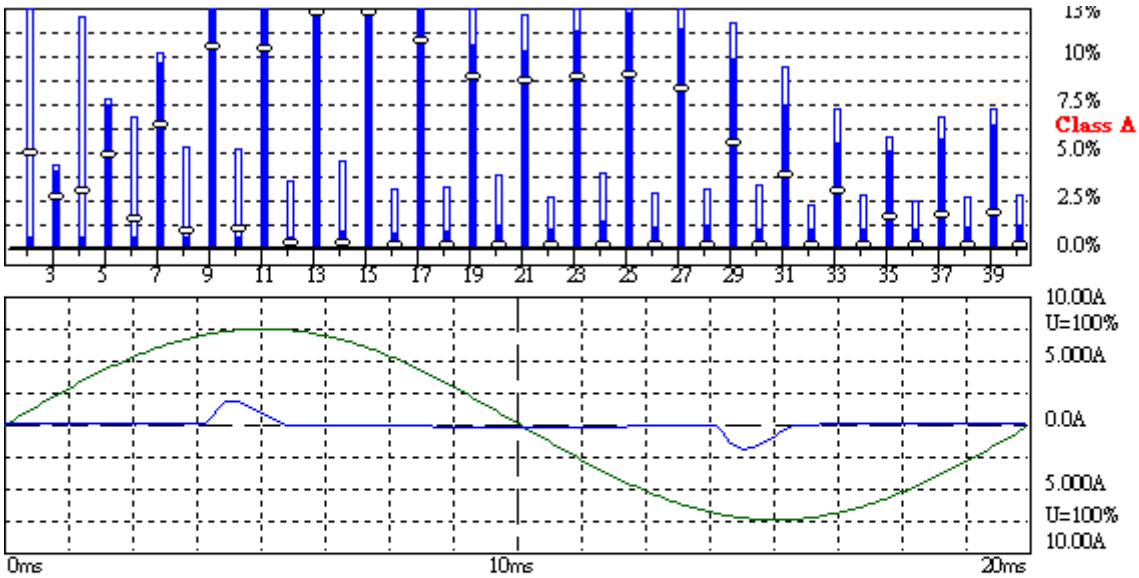

Harmonic Emission - IEC 61000-3-2 , EN 61000-3-2 , (EN60555-2)

2016/4/1 下午 02:02:

U_{rms} = 230.1 V P = 53.99 W THC = 0.431 A
 I_{rms} = 0.498 A pf = 0.471

Range: 10 A
 V-nom: 230 V
 TestTime: 5 min (100%)

Test completed, Result: PASSED

HAR-1000 EMI-Reture

Full Bar : Actual Values
 Empty Bar : Maximum Values
 Blue : Current , Green : Voltage , Red : Failed

Urms = 230.1V Freq = 50.000 Range: 10 A
 Irms = 0.498A Ipk = 1.904A cf = 3.824
 P = 53.99W S = 114.6VA pf = 0.471
 THDi = 120 % THDu = 0.10 % Class A

Test - Time : 5min (100 %)

Test completed, Result: PASSED

Order	Freq. [Hz]	Iavg [A]	Iavg%L [%]	I _{max} [A]	I _{max} %L [%]	Limit [A]	Status
1	50	1.1689		8.0261			
2	100	0.1312	12.146	0.4987	46.172	1.0800	
3	150	0.1508	6.5554	0.2417	10.509	2.3000	
4	200	0.0304	7.0622	0.1288	29.950	0.4300	
5	250	0.1362	11.951	0.2185	19.167	1.1400	
6	300	0.0104	3.4509	0.0500	16.683	0.3000	
7	350	0.1227	15.933	0.1929	25.048	0.7700	
8	400	0.0045	1.9753	0.0299	13.003	0.2300	
9	450	0.1039	25.973	0.1642	41.046	0.4000	
10	500	0.0034	1.8252	0.0232	12.605	0.1840	
11	550	0.0851	25.796	0.1331	40.320	0.3300	
12	600	0.0004	0.2301	0.0128	8.3592	0.1533	
13	650	0.0656	31.258	0.1019	48.537	0.2100	
14	700	0.0008	0.6144	0.0146	11.146	0.1314	
15	750	0.0484	32.290	0.0739	49.235	0.1500	
16	800	0.0003	0.2306	0.0085	7.4304	0.1150	
17	850	0.0352	26.576	0.0519	39.198	0.1324	
18	900	0.0000	0.0432	0.0079	7.7621	0.1022	
19	950	0.0261	22.074	0.0378	31.955	0.1184	
20	1000	0.0003	0.3165	0.0085	9.2880	0.0920	
21	1050	0.0233	21.720	0.0323	30.192	0.1071	
22	1100	0.0000	0.0067	0.0055	6.5679	0.0836	
23	1150	0.0214	21.869	0.0317	32.444	0.0978	
24	1200	0.0001	0.1309	0.0073	9.5533	0.0767	
25	1250	0.0199	22.131	0.0305	33.908	0.0900	
26	1300	0.0000	0.0079	0.0049	6.8996	0.0708	
27	1350	0.0172	20.618	0.0275	32.959	0.0833	
28	1400	0.0000	0.0000	0.0049	7.4304	0.0657	
29	1450	0.0106	13.645	0.0226	29.107	0.0776	
30	1500	0.0000	0.0000	0.0049	7.9611	0.0613	
31	1550	0.0068	9.4155	0.0171	23.546	0.0726	
32	1600	0.0000	0.0000	0.0031	5.3074	0.0575	
33	1650	0.0047	6.8569	0.0122	17.904	0.0682	
34	1700	0.0000	0.0000	0.0037	6.7669	0.0541	
35	1750	0.0023	3.5751	0.0092	14.242	0.0643	
36	1800	0.0000	0.0000	0.0031	5.9708	0.0511	
37	1850	0.0024	3.9732	0.0104	17.063	0.0608	
38	1900	0.0000	0.0000	0.0031	6.3025	0.0484	
39	1950	0.0024	4.1916	0.0104	17.985	0.0577	
40	2000	0.0000	0.0000	0.0031	6.6343	0.0460	

Product	Printer		
Test Item	Power Harmonics		
Test Mode	Mode 5: PC Printing (72W)		
Date of Test	2016/01/06	Test Site	SR1

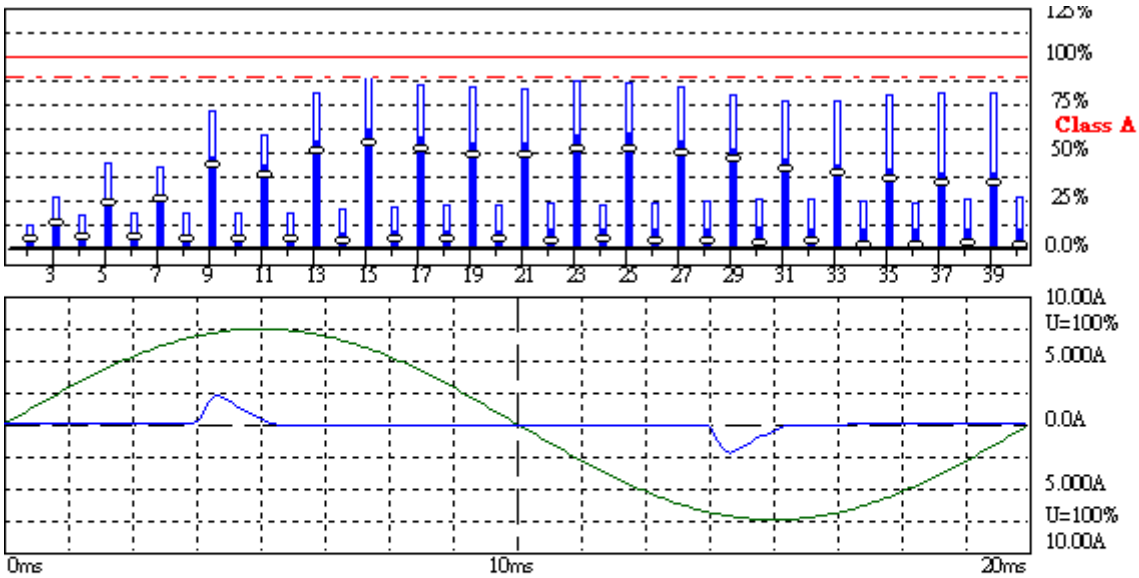

Harmonic Emission - IEC 61000-3-2 , EN 61000-3-2 , (EN60555-2)

2016/1/6 上午 11:46:

U_{rms} = 230.1 V P = 52.27 W THC = 0.592 A
 I_{rms} = 0.498 A pf = 0.456

Range: 10 A
 V_{nom}: 230 V
 TestTime: 5 min (100%)

Test completed, Result: PASSED

HAR-1000 EMC-Reture

- Full Bar : Actual Values
- Empty Bar : Maximum Values
- Blue : Current , Green : Voltage , Red : Failed

Urms = 230.1V Freq = 49.987 Range: 10 A
 Irms = 0.498A Ipk = 2.246A cf = 4.510
 P = 52.27W S = 114.6VA pf = 0.456
 THDi = 44.0 % THDu = 0.20 % Class A

Test - Time : 5min (100 %)

Test completed, Result: PASSED

Order	Freq. [Hz]	Iavg [A]	Iavg%L [%]	Imax [A]	Imax%L [%]	Limit [A]	Status
1	50	1.4799		3.4979			
2	100	0.0353	3.2705	0.1184	10.964	1.0800	
3	150	0.2737	11.899	0.5713	24.839	2.3000	
4	200	0.0175	4.0752	0.0684	15.898	0.4300	
5	250	0.2561	22.463	0.4919	43.153	1.1400	
6	300	0.0115	3.8308	0.0500	16.683	0.3000	
7	350	0.1847	23.990	0.3131	40.664	0.7700	
8	400	0.0077	3.3310	0.0385	16.718	0.2300	
9	450	0.1661	41.531	0.2802	70.038	0.4000	
10	500	0.0057	3.1211	0.0305	16.586	0.1840	
11	550	0.1215	36.832	0.1898	57.521	0.3300	
12	600	0.0049	3.1790	0.0275	17.912	0.1533	
13	650	0.1041	49.561	0.1691	80.508	0.2100	
14	700	0.0039	2.9800	0.0256	19.505	0.1314	
15	750	0.0804	53.588	0.1318	87.891	0.1500	
16	800	0.0034	2.9631	0.0232	20.168	0.1150	
17	850	0.0663	50.112	0.1123	84.852	0.1324	
18	900	0.0028	2.7255	0.0214	20.898	0.1022	
19	950	0.0565	47.674	0.0983	82.981	0.1184	
20	1000	0.0028	3.0162	0.0201	21.893	0.0920	
21	1050	0.0513	47.836	0.0879	82.031	0.1071	
22	1100	0.0026	3.0921	0.0189	22.623	0.0836	
23	1150	0.0491	50.241	0.0842	86.100	0.0978	
24	1200	0.0023	2.9391	0.0165	21.495	0.0767	
25	1250	0.0454	50.410	0.0769	85.449	0.0900	
26	1300	0.0019	2.6377	0.0159	22.424	0.0708	
27	1350	0.0404	48.491	0.0690	82.764	0.0833	
28	1400	0.0016	2.4289	0.0153	23.220	0.0657	
29	1450	0.0348	44.801	0.0610	78.668	0.0776	
30	1500	0.0014	2.3220	0.0146	23.883	0.0613	
31	1550	0.0294	40.454	0.0555	76.525	0.0726	
32	1600	0.0011	1.9175	0.0140	24.414	0.0575	
33	1650	0.0256	37.569	0.0519	76.090	0.0682	
34	1700	0.0008	1.3914	0.0128	23.684	0.0541	
35	1750	0.0224	34.859	0.0507	78.803	0.0643	
36	1800	0.0005	1.0054	0.0116	22.689	0.0511	
37	1850	0.0202	33.292	0.0488	80.295	0.0608	
38	1900	0.0005	0.9530	0.0116	23.950	0.0484	
39	1950	0.0190	33.017	0.0464	80.404	0.0577	
40	2000	0.0003	0.6414	0.0116	25.210	0.0460	

Product	Printer		
Test Item	Power Harmonics		
Test Mode	Mode 6: LAN Printing (72W)		
Date of Test	2016/01/06	Test Site	SR1

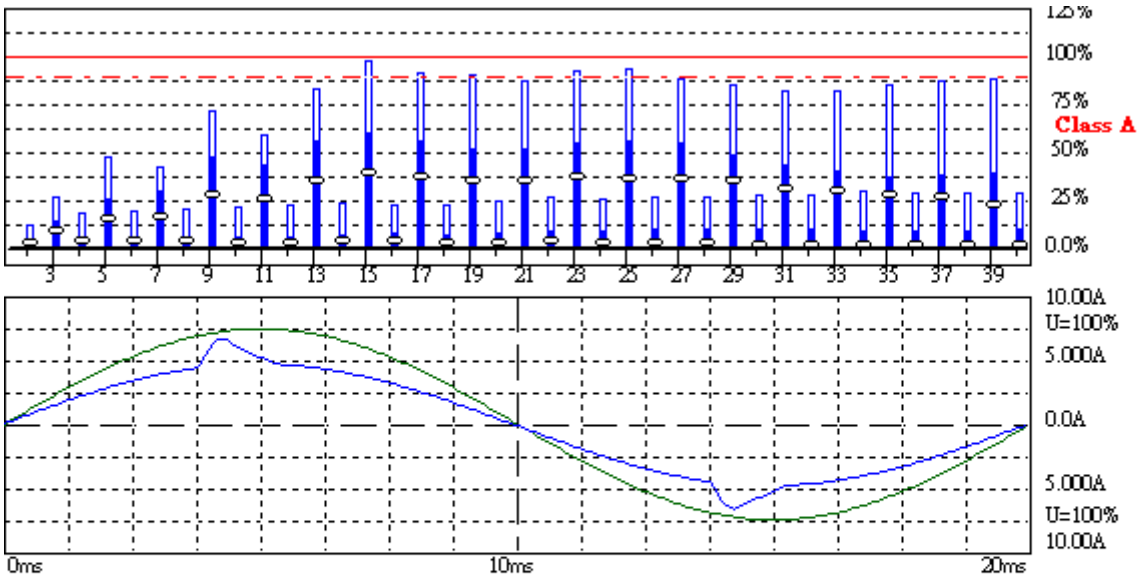

Harmonic Emission - IEC 61000-3-2 , EN 61000-3-2 , (EN60555-2)

2016/1/6 上午 11:57:

U_{rms} = 230.1 V P = 821.9 W THC = 0.609 A
 I_{rms} = 3.599 A pf = 0.998

Range: 10 A
 V-nom: 230 V
 TestTime: 5 min (100%)

Test completed, Result: PASSED

HAR-1000 EMC-Return

Full Bar : Actual Values
 Empty Bar : Maximum Values
 Blue : Current , Green : Voltage , Red : Failed

Urms = 230.1V Freq = 50.000 Range: 10 A
 Irms = 3.599A Ipk = 6.660A cf = 1.851
 P = 821.9W S = 828.1VA pf = 0.993
 THDi = 19.0 % THDu = 0.30 % Class A

Test - Time : 5min (100 %)

Test completed, Result: PASSED

Order	Freq. [Hz]	Iavg [A]	Iavg%L [%]	Imax [A]	Imax%L [%]	Limit [A]	Status
1	50	0.8736		6.1707			
2	100	0.0221	2.0472	0.1178	10.907	1.0800	
3	150	0.1715	7.4587	0.5786	25.157	2.3000	
4	200	0.0121	2.8023	0.0714	16.607	0.4300	
5	250	0.1594	13.979	0.5298	46.472	1.1400	
6	300	0.0082	2.7427	0.0562	18.717	0.3000	
7	350	0.1164	15.119	0.3162	41.060	0.7700	
8	400	0.0055	2.3969	0.0452	19.637	0.2300	
9	450	0.1061	26.537	0.2814	70.343	0.4000	
10	500	0.0039	2.1246	0.0366	19.903	0.1840	
11	550	0.0796	24.121	0.1917	58.076	0.3300	
12	600	0.0033	2.1487	0.0330	21.495	0.1533	
13	650	0.0699	33.285	0.1721	81.961	0.2100	
14	700	0.0028	2.1077	0.0293	22.291	0.1314	
15	750	0.0562	37.474	0.1459	97.249	0.1500	
16	800	0.0024	2.0526	0.0244	21.230	0.1150	
17	850	0.0476	35.952	0.1196	90.386	0.1324	
18	900	0.0019	1.8512	0.0226	22.092	0.1022	
19	950	0.0411	34.744	0.1056	89.166	0.1184	
20	1000	0.0018	1.9551	0.0214	23.220	0.0920	
21	1050	0.0367	34.219	0.0922	86.019	0.1071	
22	1100	0.0017	1.9898	0.0208	24.812	0.0836	
23	1150	0.0348	35.601	0.0891	91.092	0.0978	
24	1200	0.0014	1.8264	0.0189	24.679	0.0767	
25	1250	0.0320	35.583	0.0830	92.231	0.0900	
26	1300	0.0012	1.6692	0.0183	25.874	0.0708	
27	1350	0.0291	34.877	0.0726	87.158	0.0833	
28	1400	0.0009	1.4323	0.0165	25.077	0.0657	
29	1450	0.0253	32.648	0.0653	84.174	0.0776	
30	1500	0.0009	1.4198	0.0165	26.869	0.0613	
31	1550	0.0222	30.653	0.0592	81.570	0.0726	
32	1600	0.0006	1.1129	0.0153	26.537	0.0575	
33	1650	0.0195	28.538	0.0555	81.462	0.0682	
34	1700	0.0005	0.9301	0.0153	28.196	0.0541	
35	1750	0.0168	26.197	0.0543	84.500	0.0643	
36	1800	0.0003	0.6377	0.0140	27.466	0.0511	
37	1850	0.0150	24.641	0.0525	86.317	0.0608	
38	1900	0.0003	0.5583	0.0134	27.731	0.0484	
39	1950	0.0124	21.573	0.0507	87.809	0.0577	
40	2000	0.0002	0.4805	0.0128	27.864	0.0460	

Product	Printer		
Test Item	Power Harmonics		
Test Mode	Mode 7: Document Printing (72W)		
Date of Test	2016/03/18	Test Site	SR1

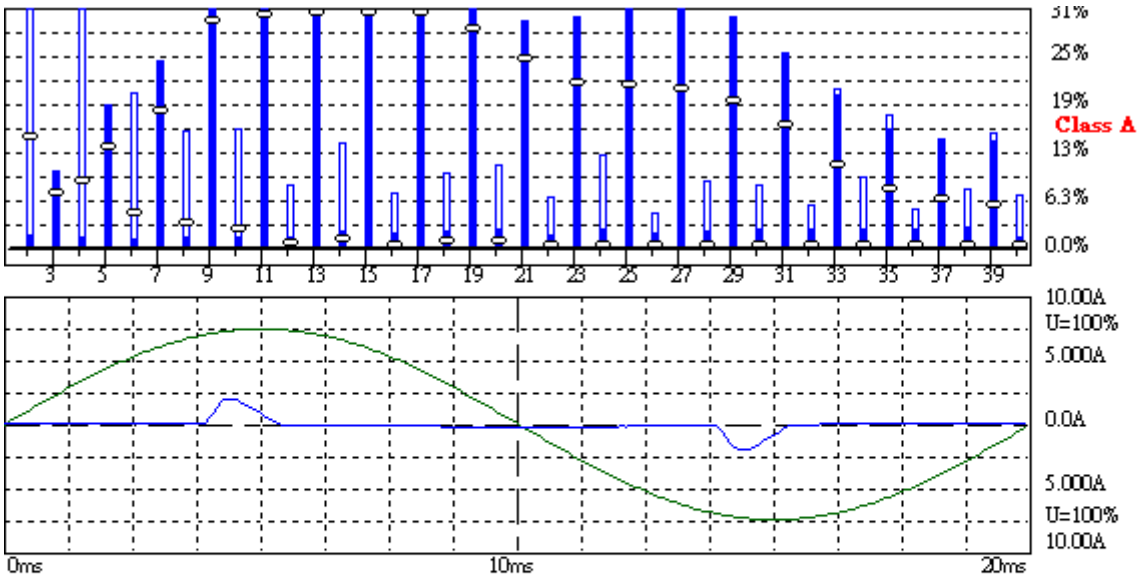

Harmonic Emission - IEC 61000-3-2 , EN 61000-3-2 , (EN60555-2)

2016/3/18 下午 04:32

U_{rms} = 230.1 V P = 55.22 W THC = 0.441 A
 I_{rms} = 0.527 A pf = 0.455

Range: 10 A
 V_{nom}: 230 V
 TestTime: 5 min (100%)

Test completed, Result: PASSED

HAR-1000 EMI-Return

- Full Bar : Actual Values
- Empty Bar : Maximum Values
- Blue : Current , Green : Voltage , Red : Failed

Urms = 230.1V Freq = 50.000 Range: 10 A
 Irms = 0.527A Ipk = 2.080A cf = 3.944
 P = 55.22W S = 121.3VA pf = 0.455
 THDi = 123 % THDu = 0.10 % Class A

Test - Time : 5min (100 %)

Test completed, Result: PASSED

Order	Freq. [Hz]	Iavg [A]	Iavg%L [%]	Imax [A]	Imax%L [%]	Limit [A]	Status
1	50	0.8973		3.0756			
2	100	0.1541	14.267	0.7007	64.878	1.0800	
3	150	0.1612	7.0098	0.2258	9.8187	2.3000	
4	200	0.0366	8.5079	0.1544	35.911	0.4300	
5	250	0.1470	12.893	0.2087	18.311	1.1400	
6	300	0.0130	4.3256	0.0604	20.142	0.3000	
7	350	0.1346	17.484	0.1874	24.335	0.7700	
8	400	0.0066	2.8753	0.0348	15.126	0.2300	
9	450	0.1169	29.232	0.1605	40.131	0.4000	
10	500	0.0044	2.4033	0.0281	15.259	0.1840	
11	550	0.0992	30.069	0.1318	39.950	0.3300	
12	600	0.0004	0.2453	0.0122	7.9611	0.1533	
13	650	0.0799	38.026	0.1031	49.119	0.2100	
14	700	0.0015	1.1597	0.0177	13.468	0.1314	
15	750	0.0621	41.373	0.0769	51.270	0.1500	
16	800	0.0001	0.1216	0.0079	6.8996	0.1150	
17	850	0.0463	34.999	0.0555	41.965	0.1324	
18	900	0.0003	0.3037	0.0098	9.5533	0.1022	
19	950	0.0339	28.594	0.0403	34.017	0.1184	
20	1000	0.0003	0.3405	0.0098	10.615	0.0920	
21	1050	0.0264	24.665	0.0317	29.622	0.1071	
22	1100	0.0000	0.0067	0.0055	6.5679	0.0836	
23	1150	0.0208	21.261	0.0293	29.948	0.0978	
24	1200	0.0002	0.2389	0.0092	11.942	0.0767	
25	1250	0.0191	21.179	0.0287	31.874	0.0900	
26	1300	0.0000	0.0000	0.0031	4.3123	0.0708	
27	1350	0.0173	20.719	0.0262	31.494	0.0833	
28	1400	0.0000	0.0096	0.0055	8.3592	0.0657	
29	1450	0.0147	18.971	0.0232	29.894	0.0776	
30	1500	0.0000	0.0000	0.0049	7.9611	0.0613	
31	1550	0.0115	15.786	0.0183	25.228	0.0726	
32	1600	0.0000	0.0000	0.0031	5.3074	0.0575	
33	1650	0.0076	11.133	0.0140	20.589	0.0682	
34	1700	0.0000	0.0103	0.0049	9.0226	0.0541	
35	1750	0.0050	7.7999	0.0110	17.090	0.0643	
36	1800	0.0000	0.0000	0.0024	4.7767	0.0511	
37	1850	0.0036	5.9899	0.0085	14.052	0.0608	
38	1900	0.0000	0.0000	0.0037	7.5631	0.0484	
39	1950	0.0032	5.4703	0.0085	14.811	0.0577	
40	2000	0.0000	0.0000	0.0031	6.6343	0.0460	

Product	Printer		
Test Item	Power Harmonics		
Test Mode	Mode 8: WiFi Printing (72W)		
Date of Test	2016/04/01	Test Site	SR1

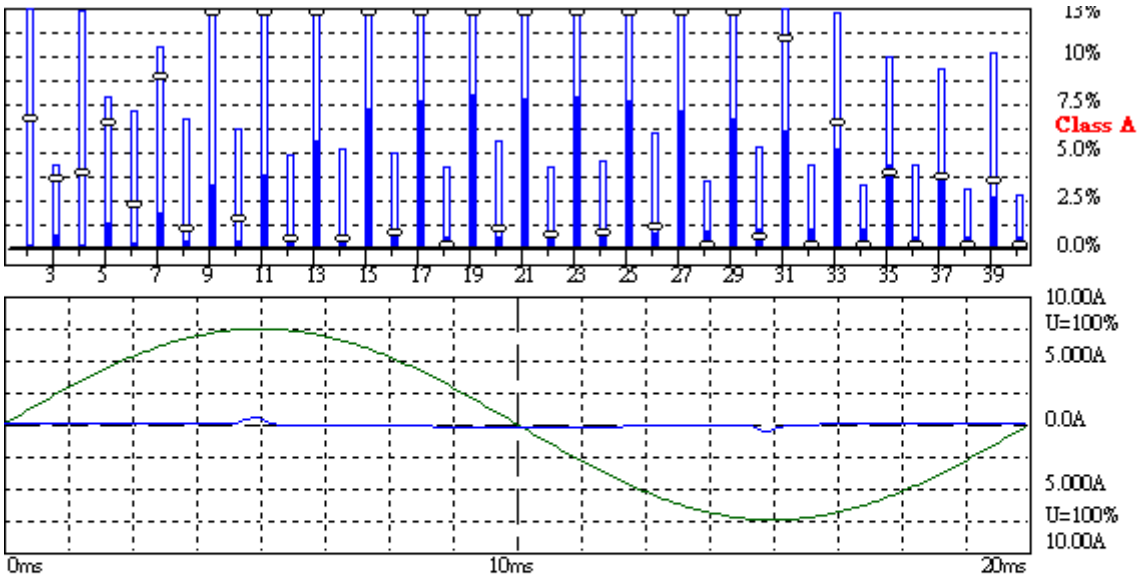

Harmonic Emission - IEC 61000-3-2 , EN 61000-3-2 , (EN60555-2)

2016/4/1 下午 01:21:

U_{rms} = 230.1 V P = 9.326 W THC = 0.099 A
 I_{rms} = 0.151 A pf = 0.268

Range: 10 A
 V_{nom}: 230 V
 TestTime: 5 min (100%)

Test completed, Result: PASSED

HAR-1000 EMI-Return

- Full Bar : Actual Values
- Empty Bar : Maximum Values
- Blue : Current , Green : Voltage , Red : Failed

Urms = 230.1V Freq = 50.000 Range: 10 A
 Irms = 0.151A Ipk = 0.605A cf = 4.000
 P = 9.326W S = 34.83VA pf = 0.268
 THDi = 87.9 % THDu = 0.10 % Class A

Test - Time : 5min (100 %)

Test completed, Result: PASSED

Order	Freq. [Hz]	Iavg [A]	Iavg%L [%]	Imax [A]	Imax%L [%]	Limit [A]	Status
1	50	1.5789		7.1442			
2	100	0.1779	16.472	0.4968	46.002	1.0800	
3	150	0.2040	8.8716	0.2466	10.721	2.3000	
4	200	0.0410	9.5378	0.1324	30.801	0.4300	
5	250	0.1844	16.172	0.2228	19.542	1.1400	
6	300	0.0157	5.2191	0.0525	17.497	0.3000	
7	350	0.1683	21.860	0.2002	25.999	0.7700	
8	400	0.0055	2.3801	0.0378	16.453	0.2300	
9	450	0.1433	35.824	0.1709	42.725	0.4000	
10	500	0.0064	3.4904	0.0281	15.259	0.1840	
11	550	0.1197	36.271	0.1422	43.095	0.3300	
12	600	0.0010	0.6607	0.0183	11.942	0.1533	
13	650	0.0955	45.479	0.1135	54.060	0.2100	
14	700	0.0015	1.1368	0.0165	12.539	0.1314	
15	750	0.0726	48.423	0.0879	58.594	0.1500	
16	800	0.0016	1.4263	0.0140	12.207	0.1150	
17	850	0.0581	43.892	0.0696	52.572	0.1324	
18	900	0.0001	0.0616	0.0104	10.150	0.1022	
19	950	0.0461	38.909	0.0562	47.418	0.1184	
20	1000	0.0018	2.0100	0.0128	13.932	0.0920	
21	1050	0.0410	38.265	0.0500	46.712	0.1071	
22	1100	0.0014	1.6368	0.0085	10.217	0.0836	
23	1150	0.0392	40.119	0.0476	48.665	0.0978	
24	1200	0.0010	1.3223	0.0085	11.146	0.0767	
25	1250	0.0349	38.784	0.0439	48.828	0.0900	
26	1300	0.0016	2.2762	0.0104	14.662	0.0708	
27	1350	0.0326	39.139	0.0397	47.607	0.0833	
28	1400	0.0000	0.0000	0.0055	8.3592	0.0657	
29	1450	0.0265	34.178	0.0330	42.480	0.0776	
30	1500	0.0005	0.8937	0.0079	12.937	0.0613	
31	1550	0.0198	27.256	0.0262	36.160	0.0726	
32	1600	0.0001	0.2529	0.0061	10.615	0.0575	
33	1650	0.0113	16.557	0.0208	30.436	0.0682	
34	1700	0.0000	0.0000	0.0043	7.8948	0.0541	
35	1750	0.0061	9.4748	0.0159	24.685	0.0643	
36	1800	0.0000	0.0547	0.0055	10.747	0.0511	
37	1850	0.0055	9.0516	0.0140	23.085	0.0608	
38	1900	0.0000	0.0000	0.0037	7.5631	0.0484	
39	1950	0.0051	8.9083	0.0146	25.391	0.0577	
40	2000	0.0000	0.0000	0.0031	6.6343	0.0460	

6.7. Test Photograph

Test Mode : Mode 1: PC Printing (110W)

Description : Power Harmonics Test Setup



Test Mode : Mode 2: LAN Printing (110W)

Description : Power Harmonics Test Setup



Test Mode : Mode 3: Document Printing (110W)
Description : Power Harmonics Test Setup



Test Mode : Mode 4: WiFi Printing (110W)
Description : Power Harmonics Test Setup



Test Mode : Mode 5: PC Printing (72W)
Description : Power Harmonics Test Setup



Test Mode : Mode 6: LAN Printing (72W)
Description : Power Harmonics Test Setup



Test Mode : Mode 7: Document Printing (72W)

Description : Power Harmonics Test Setup



Test Mode : Mode 8: WiFi Printing (72W)

Description : Power Harmonics Test Setup



7. Voltage Fluctuation and Flicker

7.1. Test Specification

According to EMC Standard : EN 61000-3-3

7.2. Test Setup

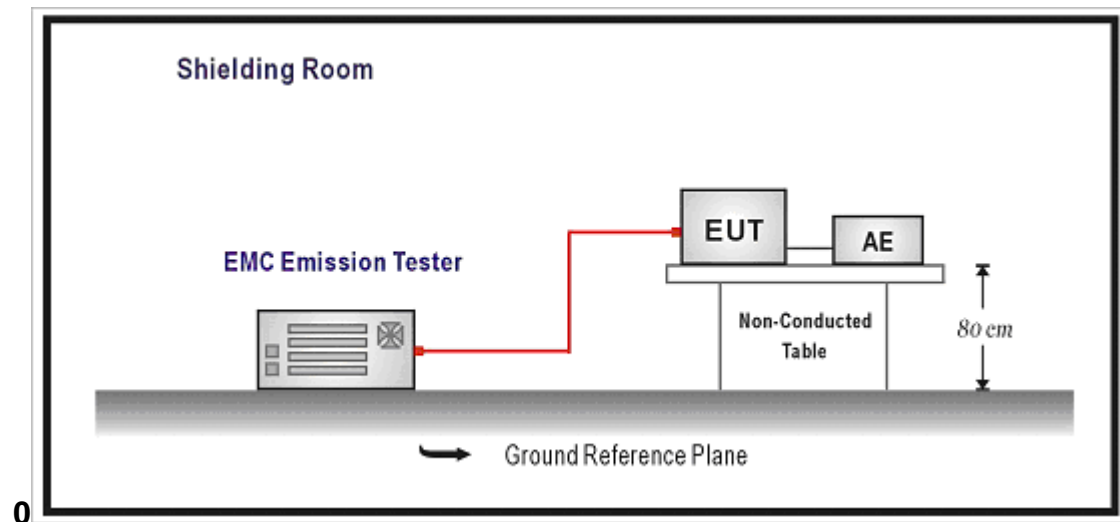

7.3. Limit

The following limits apply:

- the value of P_{st} shall not be greater than 1.0;
- the value of P_{1t} shall not be greater than 0.65;
- the value of $d(t)$ during a voltage change shall not exceed 3.3 % for more than 500 ms;
- the relative steady-state voltage change, d_c , shall not exceed 3.3 %;
- the maximum relative voltage change, d_{max} , shall not exceed;
 - a) 4 % without additional conditions;
 - b) 6 % for equipment which is:
 - switched manually, or
 - switched automatically more frequently than twice per day, and also has either a delayed restart (the delay being not less than a few tens of seconds), or manual restart, after a power supply interruption.

NOTE The cycling frequency will be further limited by the P_{st} and P_{1t} limit.

For example: a d_{max} of 6% producing a rectangular voltage change characteristic twice per hour will give a P_{1t} of about 0.65.

- c) 7 % for equipment which is:
- attended whilst in use (for example: hair dryers, vacuum cleaners, kitchen equipment such as mixers, garden equipment such as lawn mowers, portable tools such as electric drills), or
 - switched on automatically, or is intended to be switched on manually, no more than twice per day, and also has either a delayed restart (the delay being not less than a few tens of seconds) or manual restart, after a power supply interruption.

P_{st} and P_{1t} requirements shall not be applied to voltage changes caused by manual switching.

7.4. Test Procedure

The EUT is supplied in series with power analyzer from a power source having the same normal voltage and frequency as the rated supply voltage and the equipment under test. And the rated voltage at the supply voltage of EUT of 0.94 times and 1.06 times shall be performed.

7.5. Deviation from Test Standard

No deviation.

7.6. Test Result

Product	Printer		
Test Item	Voltage Fluctuation and Flicker		
Test Mode	Mode 1: PC Printing (110W)		
Date of Test	2016/04/01	Test Site	SR1

Flickermeter 1000-4-15 for 230V/50Hz

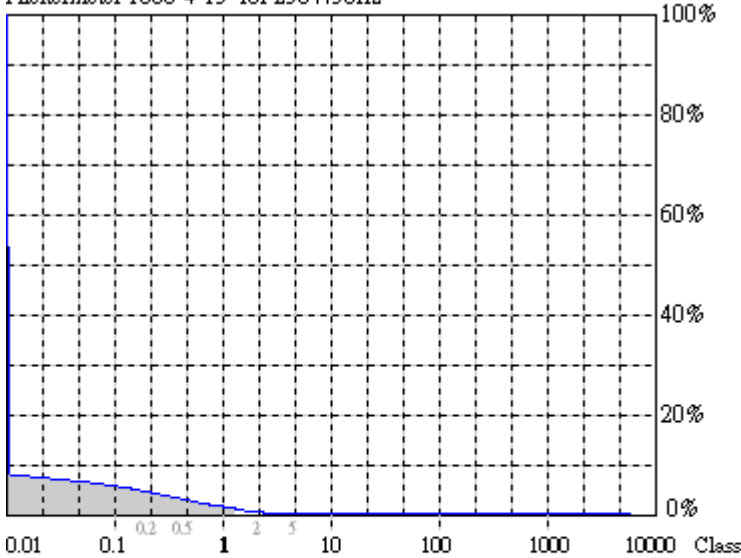

Actual Flicker (Fli): 0.00
Short-term Flicker (Pst): 0.42
 Limit (Pst): 1.00
Long-term Flicker (Plt): 0.53
 Limit (Plt): 0.65
Maximum Relative Volt. Change (dmax): 1.92%
 Limit (dmax): 4.00%
Relative Steady-state Voltage Change (dc): 0.62%
 Limit (dc): 3.30%
Maximum Interval exceeding 3.30% (dt): 0.00ms
 Limit (dt>Lim): 500ms

Flicker Emission - IEC 61000-3-3 , EN 61000-3-3

Urms = 230.1 V P = 9.081 W
 Irms = 0.142 A pf = 0.279

2016/4/1 下午 06:14:

Range: 10 A
 V-nom: 230 V
 TestTime: 120 min (10000%)

Test completed, Result: PASSED

BAR-1000 EMC-Printer

Full Bar : Actual Values
 Empty Bar : Maximum Values
 Circles : Average Values
 Blue : Current , Green : Voltage , Red : Failed

Urms = 230.1V Freq = 50.000 Range: 10 A
 Irms = 0.142A Ipk = 0.464A cf = 3.276
 P = 9.081W S = 32.58VA pf = 0.279

Test - Time : 12 x 10min = 120min (10000 %)

LIN (Line Impedance Network) : L: 0.24ohm +j0.15ohm N: 0.16ohm +j0.10ohm

Limits : Plt : 0.65 Pst : 1.00
 dmax : 4.00 % dc : 3.30 %
 dtLim: 3.30 % dt>Lim: 500ms

Test completed, Result: PASSED

Product	Printer		
Test Item	Voltage Fluctuation and Flicker		
Test Mode	Mode 2: LAN Printing (110W)		
Date of Test	2016/03/25	Test Site	SR1

Flickermeter 1000-4-15 for 230V/50Hz

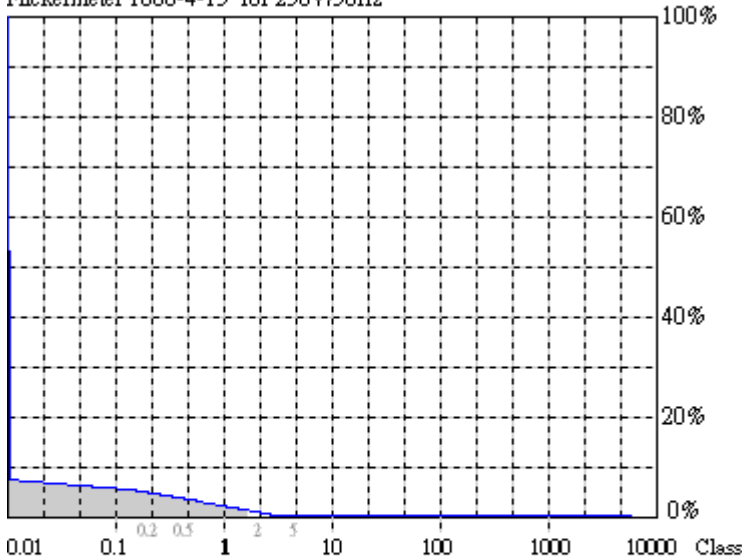

Actual Flicker (Fli): 0.00
Short-term Flicker (Pst): 0.46
 Limit (Pst): 1.00
Long-term Flicker (Plt): 0.55
 Limit (Plt): 0.65
Maximum Relative Volt. Change (dmax): 1.94%
 Limit (dmax): 4.00%
Relative Steady-state Voltage Change (dc): 0.01%
 Limit (dc): 3.30%
Maximum Interval exceeding 3.30% (dt): 0.00ms
 Limit (dt>Lim): 500ms

Flicker Emission - IEC 61000-3-3 , EN 61000-3-3

U_{rms} = 230.1 V P = 5.645 W
 I_{rms} = 0.122 A pf = 0.201

2016/3/25 下午 08:25

Range: 10 A
 V_{nom}: 230 V
 TestTime: 120 min (10000%)

Test completed, Result: PASSED

BAR-1000 FMC-Peter

Full Bar : Actual Values
 Empty Bar : Maximum Values
 Circles : Average Values
 Blue : Current , Green : Voltage , Red : Failed

Urms = 230.1V Freq = 50.000 Range: 10 A
 Irms = 0.122A Ipk = 0.347A cf = 2.840
 P = 5.645W S = 28.09VA pf = 0.201

Test - Time : 12 x 10min = 120min (10000 %)

LIN (Line Impedance Network) : L: 0.24ohm +j0.15ohm N: 0.16ohm +j0.10ohm

Limits : Plt : 0.65 Pst : 1.00
 dmax : 4.00 % dc : 3.30 %
 dtLim: 3.30 % dt>Lim: 500ms

Test completed, Result: PASSED

Product	Printer		
Test Item	Voltage Fluctuation and Flicker		
Test Mode	Mode 3: Document Printing (110W)		
Date of Test	2016/03/18	Test Site	SR1

Flickermeter 1000-4-15 for 230V/50Hz

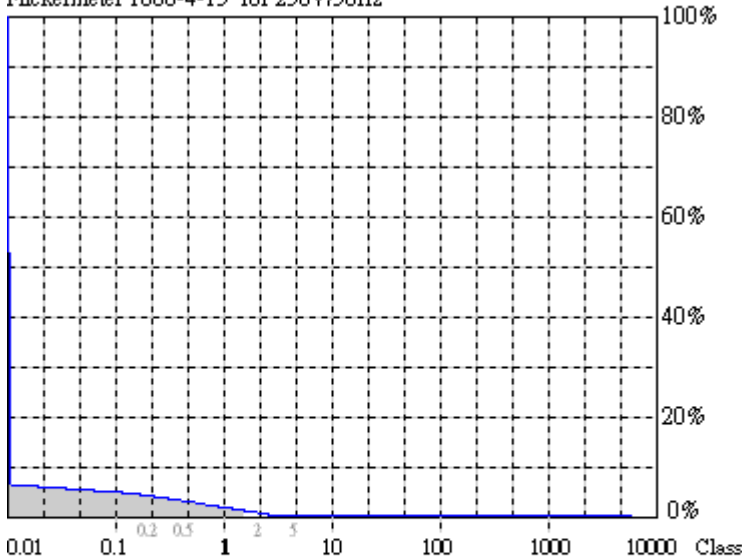

Actual Flicker (Fli): 0.00
Short-term Flicker (Pst): 0.44
 Limit (Pst): 1.00
Long-term Flicker (Plt): 0.54
 Limit (Plt): 0.65
Maximum Relative Volt. Change (dmax): 2.11%
 Limit (dmax): 4.00%
Relative Steady-state Voltage Change (dc): 0.01%
 Limit (dc): 3.30%
Maximum Interval exceeding 3.30% (dt): 0.00ms
 Limit (dt>Lim): 500ms

Flicker Emission - IEC 61000-3-3 , EN 61000-3-3

U_{rms} = 230.1 V P = 6.626 W
 I_{rms} = 0.127 A pf = 0.227

2016/3/18 下午 06:52

Range: 10 A
 V_{nom}: 230 V
 TestTime: 120 min (10000%)

Test completed, Result: PASSED

BAR-1000 BNC-Power

Full Bar : Actual Values
 Empty Bar : Maximum Values
 Circles : Average Values
 Blue : Current , Green : Voltage , Red : Failed

Urms = 230.1V Freq = 50.000 Range: 10 A
 Irms = 0.127A Ipk = 0.352A cf = 2.769
 P = 6.626W S = 29.21VA pf = 0.227

Test - Time : 12 x 10min = 120min (10000 %)

LIN (Line Impedance Network) : L: 0.24ohm +j0.15ohm N: 0.16ohm +j0.10ohm

Limits : Plt : 0.65 Pst : 1.00
 dmax : 4.00 % dc : 3.30 %
 dtLim: 3.30 % dt>Lim: 500ms

Test completed, Result: PASSED

Product	Printer		
Test Item	Voltage Fluctuation and Flicker		
Test Mode	Mode 4: WiFi Printing (110W)		
Date of Test	2016/04/01	Test Site	SR1

Flickermeter 1000-4-15 for 230V/50Hz

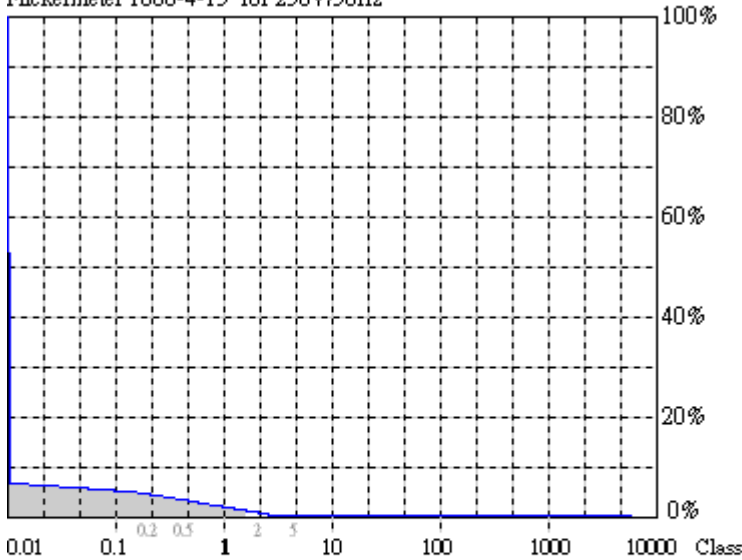

Actual Flicker (Fli): 1.91
Short-term Flicker (Pst): 0.44
 Limit (Pst): 1.00
Long-term Flicker (Plt): 0.55
 Limit (Plt): 0.65
Maximum Relative Volt. Change (dmax): 1.95%
 Limit (dmax): 4.00%
Relative Steady-state Voltage Change (dc): 0.01%
 Limit (dc): 3.30%
Maximum Interval exceeding 3.30% (dt): 0.00ms
 Limit (dt>Lim): 500ms

Flicker Emission - IEC 61000-3-3 , EN 61000-3-3

U_{rms} = 230.1 V P = 6.872 W
 I_{rms} = 0.127 A pf = 0.235

2016/4/1 下午 04:08:

Range: 10 A
 V_{nom}: 230 V
 TestTime: 120 min (10000%)

Test completed, Result: PASSED

BAR-1000 FMC-Meter

Full Bar : Actual Values
 Empty Bar : Maximum Values
 Circles : Average Values
 Blue : Current , Green : Voltage , Red : Failed

Urms = 230.1V Freq = 49.987 Range: 10 A
 Irms = 0.127A Ipk = 0.366A cf = 2.885
 P = 6.872W S = 29.21VA pf = 0.235

Test - Time : 12 x 10min = 120min (10000 %)

LIN (Line Impedance Network) : L: 0.24ohm +j0.15ohm N: 0.16ohm +j0.10ohm

Limits : Plt : 0.65 Pst : 1.00
 dmax : 4.00 % dc : 3.30 %
 dtLim: 3.30 % dt>Lim: 500ms

Test completed, Result: PASSED

Product	Printer		
Test Item	Voltage Fluctuation and Flicker		
Test Mode	Mode 5: PC Printing (72W)		
Date of Test	2016/03/04	Test Site	SR1

Flickermeter 1000-4-15 for 230V/50Hz

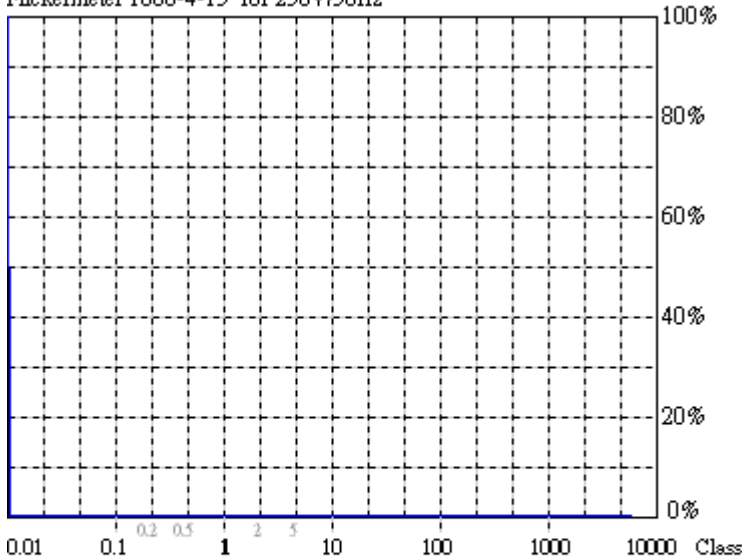

Actual Flicker (Fli): 0.00
Short-term Flicker (Pst): 0.07
 Limit (Pst): 1.00
Long-term Flicker (Plt): 0.53
 Limit (Plt): 0.65
Maximum Relative Volt. Change (dmax): 0.00%
 Limit (dmax): 4.00%
Relative Steady-state Voltage Change (dc): 0.02%
 Limit (dc): 3.30%
Maximum Interval exceeding 3.30% (dt): 0.00ms
 Limit (dt>Lim): 500ms

Flicker Emission - IEC 61000-3-3 , EN 61000-3-3

U_{rms} = 230.1 V P = 8.099 W
 I_{rms} = 0.137 A pf = 0.257

2016/3/4 下午 08:55:

Range: 10 A
 V_{nom}: 230 V
 TestTime: 120 min (10000%)

Test completed, Result: PASSED

BAR-1000 BNC-Header

Full Bar : Actual Values
 Empty Bar : Maximum Values
 Circles : Average Values
 Blue : Current , Green : Voltage , Red : Failed

Urms = 230.1V Freq = 50.000 Range: 10 A
 Irms = 0.137A Ipk = 0.420A cf = 3.071
 P = 8.099W S = 31.46VA pf = 0.257

Test - Time : 12 x 10min = 120min (10000 %)

LIN (Line Impedance Network) : L: 0.24ohm +j0.15ohm N: 0.16ohm +j0.10ohm

Limits : Plt : 0.65 Pst : 1.00
 dmax : 4.00 % dc : 3.30 %
 dtLim: 3.30 % dt>Lim: 500ms

Test completed, Result: PASSED

Product	Printer		
Test Item	Voltage Fluctuation and Flicker		
Test Mode	Mode 6: LAN Printing (72W)		
Date of Test	2016/01/06	Test Site	SR1

Flickermeter 1000-4-15 for 230V/50Hz

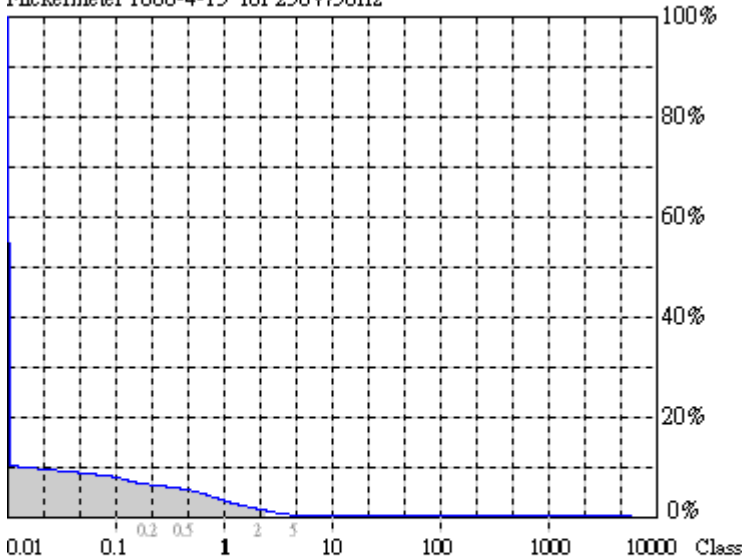

Actual Flicker (Fli): 0.00
Short-term Flicker (Pst): 0.57
 Limit (Pst): 1.00
Long-term Flicker (Plt): 0.59
 Limit (Plt): 0.65
Maximum Relative Volt. Change (dmax): 2.21%
 Limit (dmax): 4.00%
Relative Steady-state Voltage Change (dc): 0.01%
 Limit (dc): 3.30%
Maximum Interval exceeding 3.30% (dt): 0.00ms
 Limit (dt>Lim): 500ms

Flicker Emission - IEC 61000-3-3 , EN 61000-3-3

U_{rms} = 230.1 V P = 5.399 W
 I_{rms} = 0.088 A pf = 0.267

2016/1/6 下午 08:27:

Range: 10 A
 V_{nom}: 230 V
 TestTime: 120 min (10000%)

Test completed, Result: PASSED

BAR-1000 FMC-Peter

Full Bar : Actual Values
 Empty Bar : Maximum Values
 Circles : Average Values
 Blue : Current , Green : Voltage , Red : Failed

Urms = 230.1V Freq = 50.000 Range: 10 A
 Irms = 0.088A Ipk = 0.303A cf = 3.444
 P = 5.399W S = 20.22VA pf = 0.267

Test - Time : 12 x 10min = 120min (10000 %)

LIN (Line Impedance Network) : L: 0.24ohm +j0.15ohm N: 0.16ohm +j0.10ohm

Limits : Plt : 0.65 Pst : 1.00
 dmax : 4.00 % dc : 3.30 %
 dtLim: 3.30 % dt>Lim: 500ms

Test completed, Result: PASSED

Product	Printer		
Test Item	Voltage Fluctuation and Flicker		
Test Mode	Mode 7: Document Printing (72W)		
Date of Test	2016/03/25	Test Site	SR1

Flickermeter 1000-4-15 for 230V/50Hz

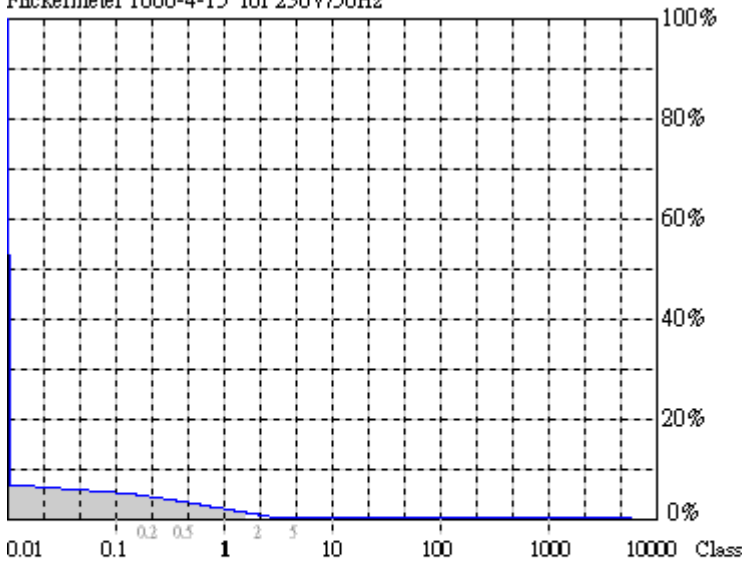

Actual Flicker (Fli): 0.00
Short-term Flicker (Pst): 0.45
 Limit (Pst): 1.00
Long-term Flicker (Plt): 0.54
 Limit (Plt): 0.65
Maximum Relative Volt. Change (dmax): 1.93%
 Limit (dmax): 4.00%
Relative Steady-state Voltage Change (dc): 0.01%
 Limit (dc): 3.30%
Maximum Interval exceeding 3.30% (dt): 0.00ms
 Limit (dt>Lim): 500ms

Flicker Emission - IEC 61000-3-3 , EN 61000-3-3

Urms = 230.3 V P = 7.608 W
 Irms = 0.132 A pf = 0.251

2016/3/25 下午 06:00

Range: 10 A
 V-nom: 230 V
 TestTime: 120 min (10000%)

Test completed, Result: PASSED

BAR-1000 FMC-Reter

Full Bar : Actual Values
 Empty Bar : Maximum Values
 Circles : Average Values
 Blue : Current , Green : Voltage , Red : Failed

Urms = 230.3V Freq = 50.013 Range: 10 A
 Irms = 0.132A Ipk = 0.420A cf = 3.185
 P = 7.608W S = 30.36VA pf = 0.251

Test - Time : 12 x 10min = 120min (10000 %)

LIN (Line Impedance Network) : L: 0.24ohm +j0.15ohm N: 0.16ohm +j0.10ohm

Limits : Plt : 0.65 Pst : 1.00
 dmax : 4.00 % dc : 3.30 %
 dtLim: 3.30 % dt>Lim: 500ms

Test completed, Result: PASSED

Product	Printer		
Test Item	Voltage Fluctuation and Flicker		
Test Mode	Mode 8: WiFi Printing (72W)		
Date of Test	2016/04/01	Test Site	SR1

Flickermeter 1000-4-15 for 230V/50Hz

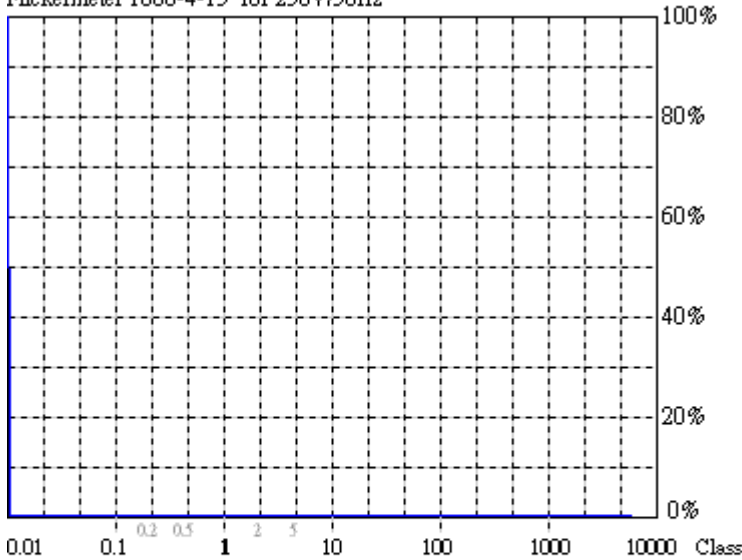

Actual Flicker (Fli): 0.00
Short-term Flicker (Pst): 0.07
 Limit (Pst): 1.00
Long-term Flicker (Plt): 0.50
 Limit (Plt): 0.65
Maximum Relative Volt. Change (dmax): 0.00%
 Limit (dmax): 4.00%
Relative Steady-state Voltage Change (dc): 0.01%
 Limit (dc): 3.30%
Maximum Interval exceeding 3.30% (dt): 0.00ms
 Limit (dt>Lim): 500ms

Flicker Emission - IEC 61000-3-3 , EN 61000-3-3

U_{rms} = 230.1 V P = 4.418 W
 I_{rms} = 0.073 A pf = 0.262

2016/4/1 下午 12:52:

Range: 10 A
 V_{nom}: 230 V
 TestTime: 120 min (10000%)

Test completed, Result: PASSED

BAR-1000 BNC-Header

Full Bar : Actual Values
 Empty Bar : Maximum Values
 Circles : Average Values
 Blue : Current , Green : Voltage , Red : Failed

Urms = 230.1V Freq = 50.000 Range: 10 A
 Irms = 0.073A Ipk = 0.269A cf = 3.667
 P = 4.418W S = 16.85VA pf = 0.262

Test - Time : 12 x 10min = 120min (10000 %)

LIN (Line Impedance Network) : L: 0.24ohm +j0.15ohm N: 0.16ohm +j0.10ohm

Limits : Plt : 0.65 Pst : 1.00
 dmax : 4.00 % dc : 3.30 %
 dtLim: 3.30 % dt>Lim: 500ms

Test completed, Result: PASSED

7.7. Test Photograph

Test Mode : Mode 1: PC Printing (110W)

Description : Voltage Fluctuation and Flicker Test Setup



Test Mode : Mode 2: LAN Printing (110W)

Description : Voltage Fluctuation and Flicker Test Setup



Test Mode : Mode 3: Document Printing (110W)
Description : Voltage Fluctuation and Flicker Test Setup



Test Mode : Mode 4: WiFi Printing (110W)
Description : Voltage Fluctuation and Flicker Test Setup



Test Mode : Mode 5: PC Printing (72W)

Description : Voltage Fluctuation and Flicker Test Setup



Test Mode : Mode 6: LAN Printing (72W)

Description : Voltage Fluctuation and Flicker Test Setup



Test Mode : Mode 7: Document Printing (72W)

Description : Voltage Fluctuation and Flicker Test Setup



Test Mode : Mode 8: WiFi Printing (72W)

Description : Voltage Fluctuation and Flicker Test Setup



8. Electrostatic Discharge

8.1. Test Specification

According to Standard : IEC 61000-4-2

8.2. Test Setup

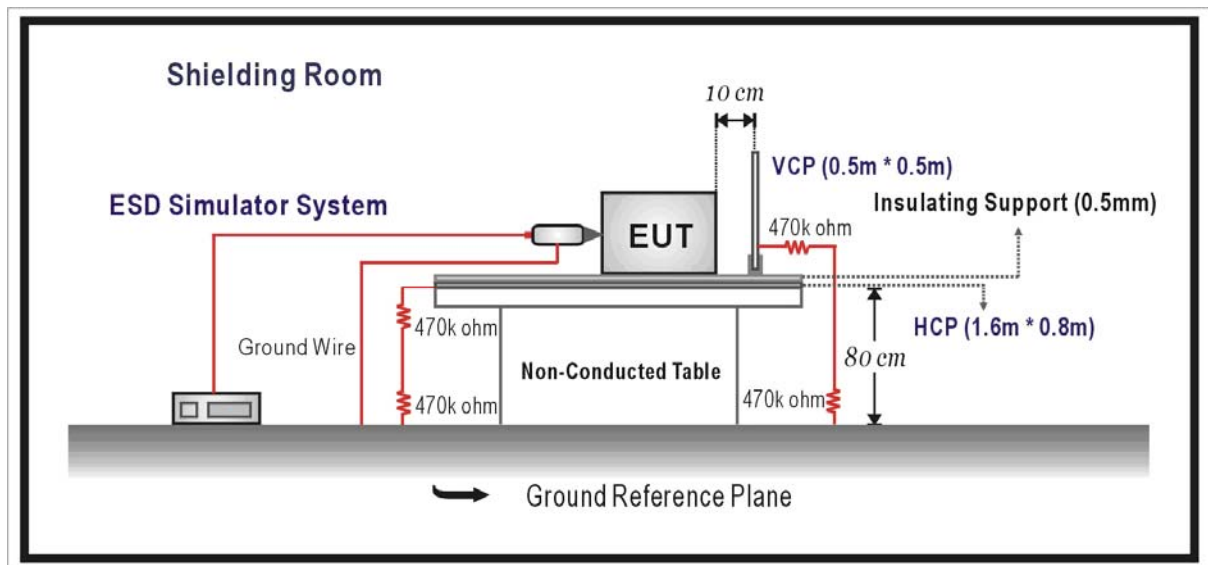

8.3. Limit

Item	Environmental Phenomena	Units	Test Specification	Performance Criteria
Enclosure Port				
	Electrostatic Discharge	kV(Charge Voltage)	±8 Air Discharge ±4 Contact Discharge	B

8.4. Test Procedure

Direct application of discharges to the EUT:

Contact discharge was applied only to conductive surfaces of the EUT.

Air discharges were applied only to non-conductive surfaces of the EUT.

During the test, it was performed with single discharges. For the single discharge time between successive single discharges will be keep longer 1 second. It was at least ten single discharges with positive and negative at the same selected point.

The selected point, which was performed with electrostatic discharge, was marked on the red label of the EUT.

Indirect application of discharges to the EUT:

Vertical Coupling Plane (VCP):

The coupling plane, of dimensions 0.5m x 0.5m, is placed parallel to, and positioned at a distance 0.1m from, the EUT, with the Discharge Electrode touching the coupling plane.

The four faces of the EUT will be performed with electrostatic discharge. It was at least ten single discharges with positive and negative at the same selected point.

Horizontal Coupling Plane (HCP):

The coupling plane is placed under to the EUT. The generator shall be positioned vertically at a distance of 0.1m from the EUT, with the Discharge Electrode touching the coupling plane.

The four faces of the EUT will be performed with electrostatic discharge. It was at least ten single discharges with positive and negative at the same selected point.

8.5. Deviation from Test Standard

No deviation.

8.6. Test Result

Product	Printer		
Test Item	Electrostatic Discharge		
Test Mode	Mode 1: PC Printing (110W)		
Date of Test	2015/12/15	Test Site	SR1

Item	Amount of Discharge	Voltage kV	Required Criteria	Complied To Criteria (A,B,C)	Results
Air Discharge	10	+8	B	A	Pass
	10	-8	B	A	Pass
Contact Discharge	25	+4	B	A	Pass
	25	-4	B	A	Pass
Indirect Discharge (HCP)	25	+4	B	A	Pass
	25	-4	B	A	Pass
Indirect Discharge (VCP Front)	25	+4	B	A	Pass
	25	-4	B	A	Pass
Indirect Discharge (VCP Left)	25	+4	B	A	Pass
	25	-4	B	A	Pass
Indirect Discharge (VCP Back)	25	+4	B	A	Pass
	25	-4	B	A	Pass
Indirect Discharge (VCP Right)	25	+4	B	A	Pass
	25	-4	B	A	Pass

NR: No Requirement

- Meet criteria A: Operate as intended during and after the test
- Meet criteria B: Operate as intended after the test
- Meet criteria C: Loss/Error of function
- Additional Information
 - EUT stopped operation and could / could not be reset by operator at ____ kV.
 - No false alarms or other malfunctions were observed during or after the test.

Remark:

1. The Contact discharges were applied-at least total 200 discharges at a minimum of four test points.
2. The testing performed is from lowest level up to the highest level as required by standard, but only highest level is shown on the report.

Product	Printer		
Test Item	Electrostatic Discharge		
Test Mode	Mode 2: LAN Printing (110W)		
Date of Test	2015/12/15	Test Site	SR1

Item	Amount of Discharge	Voltage kV	Required Criteria	Complied To Criteria (A,B,C)	Results
Air Discharge	10	+8	B	A	Pass
	10	-8	B	A	Pass
Contact Discharge	25	+4	B	A	Pass
	25	-4	B	A	Pass
Indirect Discharge (HCP)	25	+4	B	A	Pass
	25	-4	B	A	Pass
Indirect Discharge (VCP Front)	25	+4	B	A	Pass
	25	-4	B	A	Pass
Indirect Discharge (VCP Left)	25	+4	B	A	Pass
	25	-4	B	A	Pass
Indirect Discharge (VCP Back)	25	+4	B	A	Pass
	25	-4	B	A	Pass
Indirect Discharge (VCP Right)	25	+4	B	A	Pass
	25	-4	B	A	Pass

NR: No Requirement

- Meet criteria A: Operate as intended during and after the test
- Meet criteria B: Operate as intended after the test
- Meet criteria C: Loss/Error of function
- Additional Information
 - EUT stopped operation and could / could not be reset by operator at ____ kV.
 - No false alarms or other malfunctions were observed during or after the test.

Remark:

1. The Contact discharges were applied-at least total 200 discharges at a minimum of four test points.
2. The testing performed is from lowest level up to the highest level as required by standard, but only highest level is shown on the report.

Product	Printer		
Test Item	Electrostatic Discharge		
Test Mode	Mode 3: Document Printing (110W)		
Date of Test	2015/12/15	Test Site	SR1

Item	Amount of Discharge	Voltage kV	Required Criteria	Complied To Criteria (A,B,C)	Results
Air Discharge	10	+8	B	A	Pass
	10	-8	B	A	Pass
Contact Discharge	25	+4	B	A	Pass
	25	-4	B	A	Pass
Indirect Discharge (HCP)	25	+4	B	A	Pass
	25	-4	B	A	Pass
Indirect Discharge (VCP Front)	25	+4	B	A	Pass
	25	-4	B	A	Pass
Indirect Discharge (VCP Left)	25	+4	B	A	Pass
	25	-4	B	A	Pass
Indirect Discharge (VCP Back)	25	+4	B	A	Pass
	25	-4	B	A	Pass
Indirect Discharge (VCP Right)	25	+4	B	A	Pass
	25	-4	B	A	Pass

NR: No Requirement

- Meet criteria A: Operate as intended during and after the test
- Meet criteria B: Operate as intended after the test
- Meet criteria C: Loss/Error of function
- Additional Information
 - EUT stopped operation and could / could not be reset by operator at ____ kV.
 - No false alarms or other malfunctions were observed during or after the test.

Remark:

1. The Contact discharges were applied-at least total 200 discharges at a minimum of four test points.
2. The testing performed is from lowest level up to the highest level as required by standard, but only highest level is shown on the report.

Product	Printer		
Test Item	Electrostatic Discharge		
Test Mode	Mode 4: WiFi Printing (110W)		
Date of Test	2016/04/11	Test Site	SR1

Item	Amount of Discharge	Voltage kV	Required Criteria	Complied To Criteria (A,B,C)	Results
Air Discharge	10	+8	B	A	Pass
	10	-8	B	A	Pass
Contact Discharge	25	+4	B	A	Pass
	25	-4	B	A	Pass
Indirect Discharge (HCP)	25	+4	B	A	Pass
	25	-4	B	A	Pass
Indirect Discharge (VCP Front)	25	+4	B	A	Pass
	25	-4	B	A	Pass
Indirect Discharge (VCP Left)	25	+4	B	A	Pass
	25	-4	B	A	Pass
Indirect Discharge (VCP Back)	25	+4	B	A	Pass
	25	-4	B	A	Pass
Indirect Discharge (VCP Right)	25	+4	B	A	Pass
	25	-4	B	A	Pass

NR: No Requirement

- Meet criteria A: Operate as intended during and after the test
- Meet criteria B: Operate as intended after the test
- Meet criteria C: Loss/Error of function
- Additional Information
 - EUT stopped operation and could / could not be reset by operator at ____ kV.
 - No false alarms or other malfunctions were observed during or after the test.

Remark:

1. The Contact discharges were applied-at least total 200 discharges at a minimum of four test points.
2. The testing performed is from lowest level up to the highest level as required by standard, but only highest level is shown on the report.

Product	Printer		
Test Item	Electrostatic Discharge		
Test Mode	Mode 5: PC Printing (72W)		
Date of Test	2015/12/15	Test Site	SR1

Item	Amount of Discharge	Voltage kV	Required Criteria	Complied To Criteria (A,B,C)	Results
Air Discharge	10	+8	B	A	Pass
	10	-8	B	A	Pass
Contact Discharge	25	+4	B	A	Pass
	25	-4	B	A	Pass
Indirect Discharge (HCP)	25	+4	B	A	Pass
	25	-4	B	A	Pass
Indirect Discharge (VCP Front)	25	+4	B	A	Pass
	25	-4	B	A	Pass
Indirect Discharge (VCP Left)	25	+4	B	A	Pass
	25	-4	B	A	Pass
Indirect Discharge (VCP Back)	25	+4	B	A	Pass
	25	-4	B	A	Pass
Indirect Discharge (VCP Right)	25	+4	B	A	Pass
	25	-4	B	A	Pass

NR: No Requirement

- Meet criteria A: Operate as intended during and after the test
- Meet criteria B: Operate as intended after the test
- Meet criteria C: Loss/Error of function
- Additional Information
 - EUT stopped operation and could / could not be reset by operator at ____ kV.
 - No false alarms or other malfunctions were observed during or after the test.

Remark:

1. The Contact discharges were applied-at least total 200 discharges at a minimum of four test points.
2. The testing performed is from lowest level up to the highest level as required by standard, but only highest level is shown on the report.

Product	Printer		
Test Item	Electrostatic Discharge		
Test Mode	Mode 6: LAN Printing (72W)		
Date of Test	2015/12/15	Test Site	SR1

Item	Amount of Discharge	Voltage kV	Required Criteria	Complied To Criteria (A,B,C)	Results
Air Discharge	10	+8	B	A	Pass
	10	-8	B	A	Pass
Contact Discharge	25	+4	B	A	Pass
	25	-4	B	A	Pass
Indirect Discharge (HCP)	25	+4	B	A	Pass
	25	-4	B	A	Pass
Indirect Discharge (VCP Front)	25	+4	B	A	Pass
	25	-4	B	A	Pass
Indirect Discharge (VCP Left)	25	+4	B	A	Pass
	25	-4	B	A	Pass
Indirect Discharge (VCP Back)	25	+4	B	A	Pass
	25	-4	B	A	Pass
Indirect Discharge (VCP Right)	25	+4	B	A	Pass
	25	-4	B	A	Pass

NR: No Requirement

- Meet criteria A: Operate as intended during and after the test
- Meet criteria B: Operate as intended after the test
- Meet criteria C: Loss/Error of function
- Additional Information
 - EUT stopped operation and could / could not be reset by operator at ____ kV.
 - No false alarms or other malfunctions were observed during or after the test.

Remark:

1. The Contact discharges were applied-at least total 200 discharges at a minimum of four test points.
2. The testing performed is from lowest level up to the highest level as required by standard, but only highest level is shown on the report.

Product	Printer		
Test Item	Electrostatic Discharge		
Test Mode	Mode 7: Document Printing (72W)		
Date of Test	2015/12/15	Test Site	SR1

Item	Amount of Discharge	Voltage kV	Required Criteria	Complied To Criteria (A,B,C)	Results
Air Discharge	10	+8	B	A	Pass
	10	-8	B	A	Pass
Contact Discharge	25	+4	B	A	Pass
	25	-4	B	A	Pass
Indirect Discharge (HCP)	25	+4	B	A	Pass
	25	-4	B	A	Pass
Indirect Discharge (VCP Front)	25	+4	B	A	Pass
	25	-4	B	A	Pass
Indirect Discharge (VCP Left)	25	+4	B	A	Pass
	25	-4	B	A	Pass
Indirect Discharge (VCP Back)	25	+4	B	A	Pass
	25	-4	B	A	Pass
Indirect Discharge (VCP Right)	25	+4	B	A	Pass
	25	-4	B	A	Pass

NR: No Requirement

- Meet criteria A: Operate as intended during and after the test
- Meet criteria B: Operate as intended after the test
- Meet criteria C: Loss/Error of function
- Additional Information
 - EUT stopped operation and could / could not be reset by operator at ____ kV.
 - No false alarms or other malfunctions were observed during or after the test.

Remark:

1. The Contact discharges were applied-at least total 200 discharges at a minimum of four test points.
2. The testing performed is from lowest level up to the highest level as required by standard, but only highest level is shown on the report.

Product	Printer		
Test Item	Electrostatic Discharge		
Test Mode	Mode 8: WiFi Printing (72W)		
Date of Test	2016/04/11	Test Site	SR1

Item	Amount of Discharge	Voltage kV	Required Criteria	Complied To Criteria (A,B,C)	Results
Air Discharge	10	+8	B	A	Pass
	10	-8	B	A	Pass
Contact Discharge	25	+4	B	A	Pass
	25	-4	B	A	Pass
Indirect Discharge (HCP)	25	+4	B	A	Pass
	25	-4	B	A	Pass
Indirect Discharge (VCP Front)	25	+4	B	A	Pass
	25	-4	B	A	Pass
Indirect Discharge (VCP Left)	25	+4	B	A	Pass
	25	-4	B	A	Pass
Indirect Discharge (VCP Back)	25	+4	B	A	Pass
	25	-4	B	A	Pass
Indirect Discharge (VCP Right)	25	+4	B	A	Pass
	25	-4	B	A	Pass

NR: No Requirement

- Meet criteria A: Operate as intended during and after the test
- Meet criteria B: Operate as intended after the test
- Meet criteria C: Loss/Error of function
- Additional Information
 - EUT stopped operation and could / could not be reset by operator at ____ kV.
 - No false alarms or other malfunctions were observed during or after the test.

Remark:

1. The Contact discharges were applied-at least total 200 discharges at a minimum of four test points.
2. The testing performed is from lowest level up to the highest level as required by standard, but only highest level is shown on the report.

8.7. Test Photograph

Test Mode : Mode 1: PC Printing (110W)

Description : Electrostatic Discharge (ESD) Test Setup



Test Mode : Mode 2: LAN Printing (110W)

Description : Electrostatic Discharge (ESD) Test Setup



Test Mode : Mode 3: Document Printing (110W)

Description : Electrostatic Discharge (ESD) Test Setup



Test Mode : Mode 4: WiFi Printing (110W)

Description : Electrostatic Discharge (ESD) Test Setup



Test Mode : Mode 5: PC Printing (72W)

Description : Electrostatic Discharge (ESD) Test Setup



Test Mode : Mode 6: LAN Printing (72W)

Description : Electrostatic Discharge (ESD) Test Setup



Test Mode : Mode 7: Document Printing (72W)

Description : Electrostatic Discharge (ESD) Test Setup



Test Mode : Mode 8: WiFi Printing (72W)

Description : Electrostatic Discharge (ESD) Test Setup



9. Radiated Susceptibility

9.1. Test Specification

According to Standard : IEC 61000-4-3

9.2. Test Setup

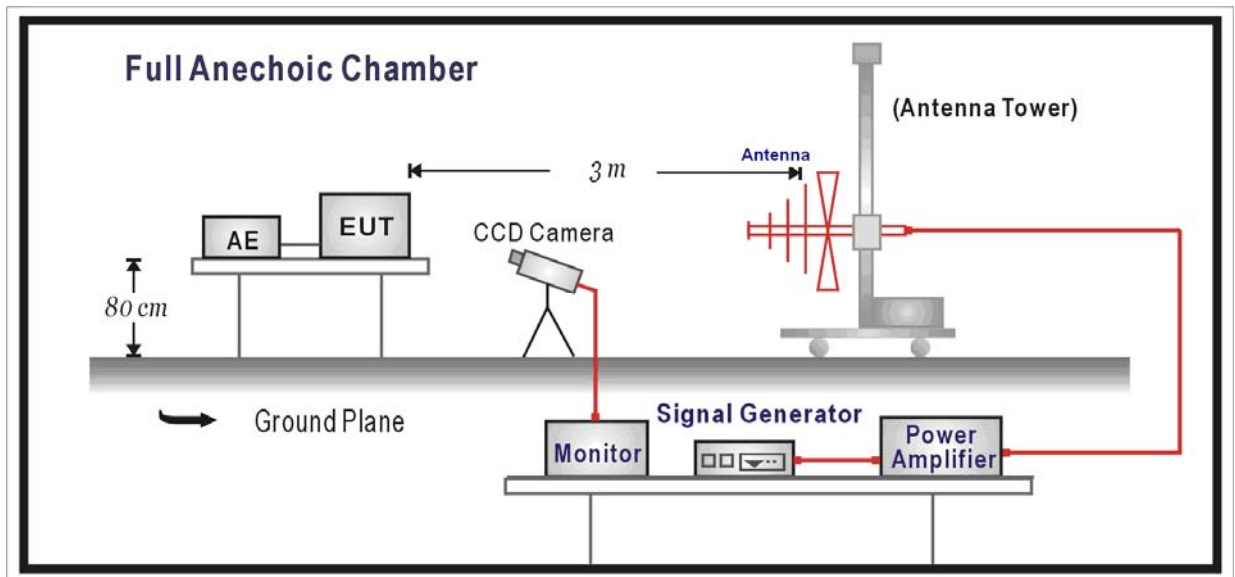

9.3. Limit

Item	Environmental Phenomena	Units	Test Specification	Performance Criteria
Enclosure Port				
	Radio-Frequency Electromagnetic Field Amplitude Modulated	MHz V/m(Un-modulated, rms) % AM (1kHz)	80-1000 3 80	A

9.4. Test Procedure

The EUT and load, which are placed on a table that is 0.8 meter above ground, are placed with one coincident with the calibration plane such that the distance from antenna to the EUT was 3 meters.

Both horizontal and vertical polarization of the antenna and four sides of the EUT are set on measurement.

In order to judge the EUT performance, a CCD camera is used to monitor EUT screen.

All the scanning conditions are as follows:

Condition of Test	Remarks
1. Field Strength	3 V/m Level 2
2. Radiated Signal	AM 80% Modulated with 1kHz
3. Scanning Frequency	80MHz - 1000MHz
4. Dwell Time	3 Seconds
5. Frequency step size Δf :	1%

9.5. Deviation from Test Standard

No deviation.

9.6. Test Result

Product	Printer		
Test Item	Radiated susceptibility		
Test Mode	Mode 1: PC Printing (110W)		
Date of Test	2015/12/09	Test Site	CB3

Frequency (MHz)	Position (Angle)	Polarity (H or V)	Field Strength (V/m)	Required Criteria	Complied To Criteria (A,B,C)	Results
80-1000	0	H	3	A	A	Pass
80-1000	0	V	3	A	A	Pass
80-1000	90	H	3	A	A	Pass
80-1000	90	V	3	A	A	Pass
80-1000	180	H	3	A	A	Pass
80-1000	180	V	3	A	A	Pass
80-1000	270	H	3	A	A	Pass
80-1000	270	V	3	A	A	Pass

- Meet criteria A : Operate as intended during and after the test
 Meet criteria B : Operate as intended after the test
 Meet criteria C : Loss/Error of function
 Additional Information
 EUT stopped operation and could / could not be reset by operator at _____ V/m at frequency _____MHz.
 No false alarms or other malfunctions were observed during or after the test. The acceptance criteria were met, and the EUT passed the test.

Product	Printer		
Test Item	Radiated susceptibility		
Test Mode	Mode 2: LAN Printing (110W)		
Date of Test	2015/12/09	Test Site	CB3

Frequency (MHz)	Position (Angle)	Polarity (H or V)	Field Strength (V/m)	Required Criteria	Complied To Criteria (A,B,C)	Results
80-1000	0	H	3	A	A	Pass
80-1000	0	V	3	A	A	Pass
80-1000	90	H	3	A	A	Pass
80-1000	90	V	3	A	A	Pass
80-1000	180	H	3	A	A	Pass
80-1000	180	V	3	A	A	Pass
80-1000	270	H	3	A	A	Pass
80-1000	270	V	3	A	A	Pass

- Meet criteria A : Operate as intended during and after the test
- Meet criteria B : Operate as intended after the test
- Meet criteria C : Loss/Error of function
- Additional Information
 - EUT stopped operation and could / could not be reset by operator at _____ V/m at frequency _____MHz.
 - No false alarms or other malfunctions were observed during or after the test. The acceptance criteria were met, and the EUT passed the test.

Product	Printer		
Test Item	Radiated susceptibility		
Test Mode	Mode 3: Document Printing (110W)		
Date of Test	2015/12/09	Test Site	CB3

Frequency (MHz)	Position (Angle)	Polarity (H or V)	Field Strength (V/m)	Required Criteria	Complied To Criteria (A,B,C)	Results
80-1000	0	H	3	A	A	Pass
80-1000	0	V	3	A	A	Pass
80-1000	90	H	3	A	A	Pass
80-1000	90	V	3	A	A	Pass
80-1000	180	H	3	A	A	Pass
80-1000	180	V	3	A	A	Pass
80-1000	270	H	3	A	A	Pass
80-1000	270	V	3	A	A	Pass

- Meet criteria A : Operate as intended during and after the test
- Meet criteria B : Operate as intended after the test
- Meet criteria C : Loss/Error of function
- Additional Information
 - EUT stopped operation and could / could not be reset by operator at _____ V/m at frequency _____MHz.
 - No false alarms or other malfunctions were observed during or after the test. The acceptance criteria were met, and the EUT passed the test.

Product	Printer		
Test Item	Radiated susceptibility		
Test Mode	Mode 4: WiFi Printing (110W)		
Date of Test	2016/04/11	Test Site	CB3

Frequency (MHz)	Position (Angle)	Polarity (H or V)	Field Strength (V/m)	Required Criteria	Complied To Criteria (A,B,C)	Results
80-1000	0	H	3	A	A	Pass
80-1000	0	V	3	A	A	Pass
80-1000	90	H	3	A	A	Pass
80-1000	90	V	3	A	A	Pass
80-1000	180	H	3	A	A	Pass
80-1000	180	V	3	A	A	Pass
80-1000	270	H	3	A	A	Pass
80-1000	270	V	3	A	A	Pass

- Meet criteria A : Operate as intended during and after the test
- Meet criteria B : Operate as intended after the test
- Meet criteria C : Loss/Error of function
- Additional Information
 - EUT stopped operation and could / could not be reset by operator at _____ V/m at frequency _____MHz.
 - No false alarms or other malfunctions were observed during or after the test. The acceptance criteria were met, and the EUT passed the test.

Product	Printer		
Test Item	Radiated susceptibility		
Test Mode	Mode 5: PC Printing (72W)		
Date of Test	2015/12/09	Test Site	CB3

Frequency (MHz)	Position (Angle)	Polarity (H or V)	Field Strength (V/m)	Required Criteria	Complied To Criteria (A,B,C)	Results
80-1000	0	H	3	A	A	Pass
80-1000	0	V	3	A	A	Pass
80-1000	90	H	3	A	A	Pass
80-1000	90	V	3	A	A	Pass
80-1000	180	H	3	A	A	Pass
80-1000	180	V	3	A	A	Pass
80-1000	270	H	3	A	A	Pass
80-1000	270	V	3	A	A	Pass

- Meet criteria A : Operate as intended during and after the test
 Meet criteria B : Operate as intended after the test
 Meet criteria C : Loss/Error of function
 Additional Information
 EUT stopped operation and could / could not be reset by operator at _____ V/m at frequency _____MHz.
 No false alarms or other malfunctions were observed during or after the test. The acceptance criteria were met, and the EUT passed the test.

Product	Printer		
Test Item	Radiated susceptibility		
Test Mode	Mode 6: LAN Printing (72W)		
Date of Test	2015/12/09	Test Site	CB3

Frequency (MHz)	Position (Angle)	Polarity (H or V)	Field Strength (V/m)	Required Criteria	Complied To Criteria (A,B,C)	Results
80-1000	0	H	3	A	A	Pass
80-1000	0	V	3	A	A	Pass
80-1000	90	H	3	A	A	Pass
80-1000	90	V	3	A	A	Pass
80-1000	180	H	3	A	A	Pass
80-1000	180	V	3	A	A	Pass
80-1000	270	H	3	A	A	Pass
80-1000	270	V	3	A	A	Pass

- Meet criteria A : Operate as intended during and after the test
 Meet criteria B : Operate as intended after the test
 Meet criteria C : Loss/Error of function
 Additional Information
 EUT stopped operation and could / could not be reset by operator at _____ V/m at frequency _____MHz.
 No false alarms or other malfunctions were observed during or after the test. The acceptance criteria were met, and the EUT passed the test.

Product	Printer		
Test Item	Radiated susceptibility		
Test Mode	Mode 7: Document Printing (72W)		
Date of Test	2015/12/09	Test Site	CB3

Frequency (MHz)	Position (Angle)	Polarity (H or V)	Field Strength (V/m)	Required Criteria	Complied To Criteria (A,B,C)	Results
80-1000	0	H	3	A	A	Pass
80-1000	0	V	3	A	A	Pass
80-1000	90	H	3	A	A	Pass
80-1000	90	V	3	A	A	Pass
80-1000	180	H	3	A	A	Pass
80-1000	180	V	3	A	A	Pass
80-1000	270	H	3	A	A	Pass
80-1000	270	V	3	A	A	Pass

- Meet criteria A : Operate as intended during and after the test
 Meet criteria B : Operate as intended after the test
 Meet criteria C : Loss/Error of function
 Additional Information
 EUT stopped operation and could / could not be reset by operator at _____ V/m at frequency _____MHz.
 No false alarms or other malfunctions were observed during or after the test. The acceptance criteria were met, and the EUT passed the test.

Product	Printer		
Test Item	Radiated susceptibility		
Test Mode	Mode 8: WiFi Printing (72W)		
Date of Test	2016/04/11	Test Site	CB3

Frequency (MHz)	Position (Angle)	Polarity (H or V)	Field Strength (V/m)	Required Criteria	Complied To Criteria (A,B,C)	Results
80-1000	0	H	3	A	A	Pass
80-1000	0	V	3	A	A	Pass
80-1000	90	H	3	A	A	Pass
80-1000	90	V	3	A	A	Pass
80-1000	180	H	3	A	A	Pass
80-1000	180	V	3	A	A	Pass
80-1000	270	H	3	A	A	Pass
80-1000	270	V	3	A	A	Pass

- Meet criteria A : Operate as intended during and after the test
 Meet criteria B : Operate as intended after the test
 Meet criteria C : Loss/Error of function
 Additional Information
 EUT stopped operation and could / could not be reset by operator at _____ V/m at frequency _____MHz.
 No false alarms or other malfunctions were observed during or after the test. The acceptance criteria were met, and the EUT passed the test.

9.7. Test Photograph

Test Mode : Mode 1: PC Printing (110W)

Description : Radiated Susceptibility (RS) Test Setup



Test Mode : Mode 2: LAN Printing (110W)

Description : Radiated Susceptibility (RS) Test Setup

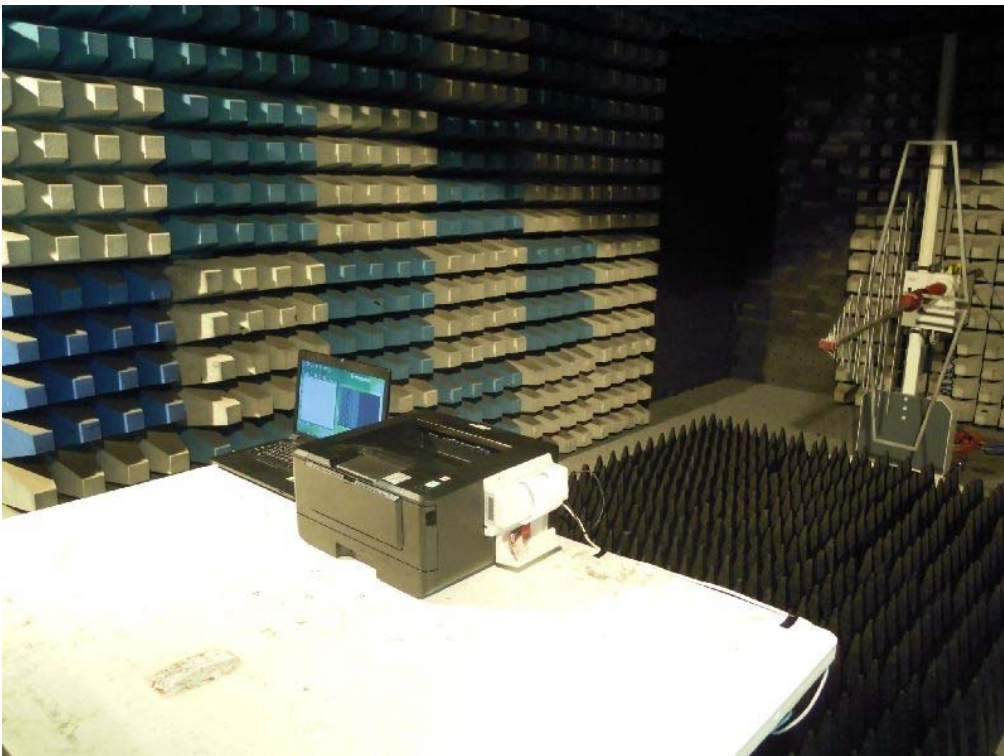

Test Mode : Mode 3: Document Printing (110W)

Description : Radiated Susceptibility (RS) Test Setup

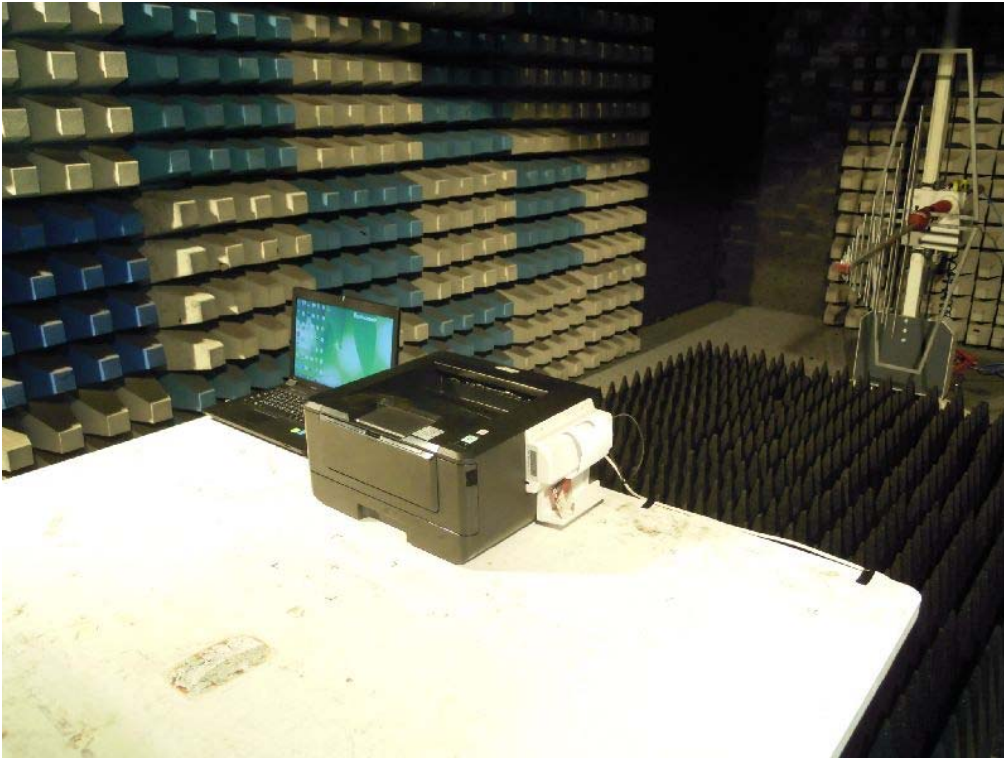

Test Mode : Mode 4: WiFi Printing (110W)

Description : Radiated Susceptibility (RS) Test Setup



Test Mode : Mode 5: PC Printing (72W)

Description : Radiated Susceptibility (RS) Test Setup

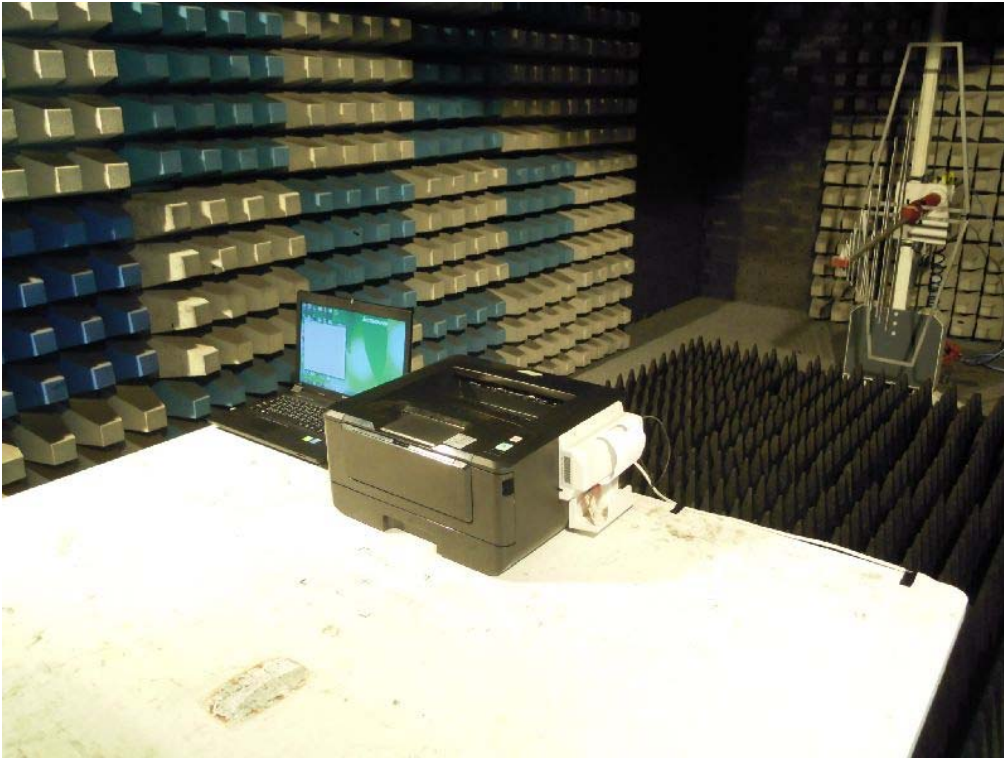

Test Mode : Mode 6: LAN Printing (72W)

Description : Radiated Susceptibility (RS) Test Setup

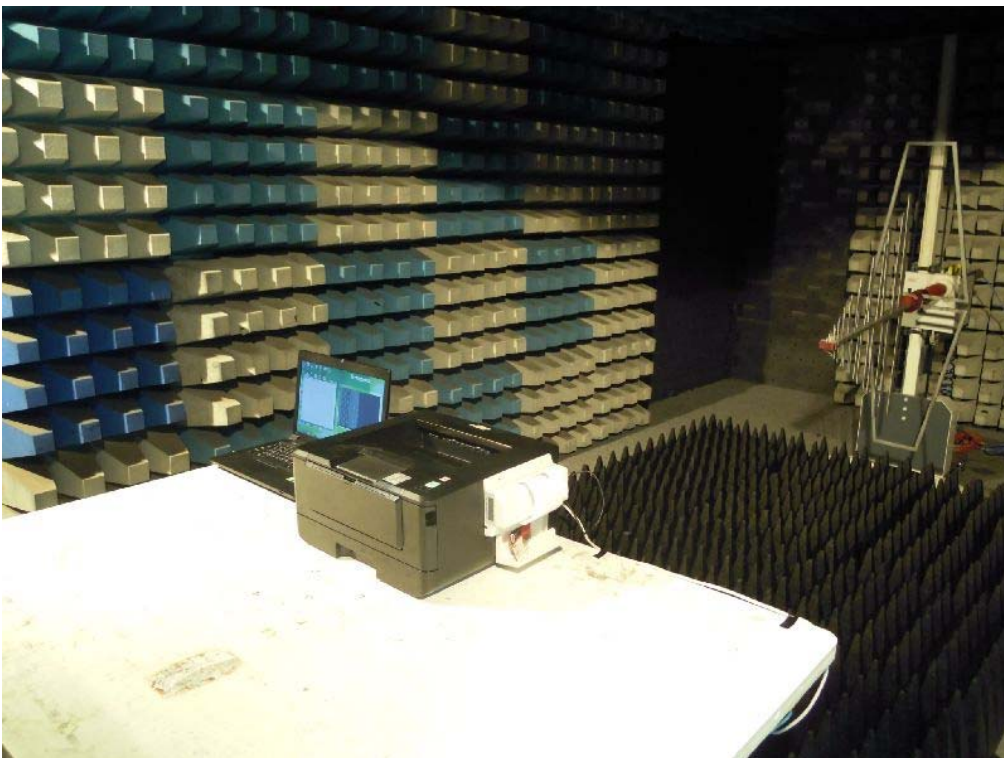

Test Mode : Mode 7: Document Printing (72W)

Description : Radiated Susceptibility (RS) Test Setup

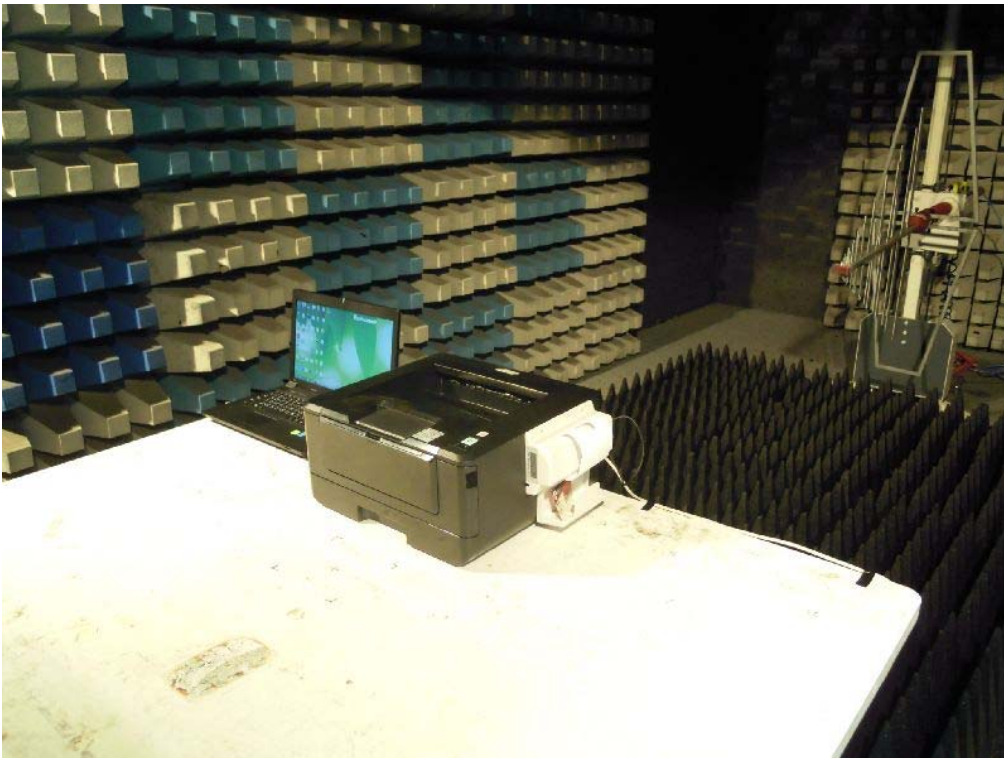

Test Mode : Mode 8: WiFi Printing (72W)

Description : Radiated Susceptibility (RS) Test Setup



10. Electrical Fast Transient/Burst

10.1. Test Specification

According to Standard : IEC 61000-4-4

10.2. Test Setup

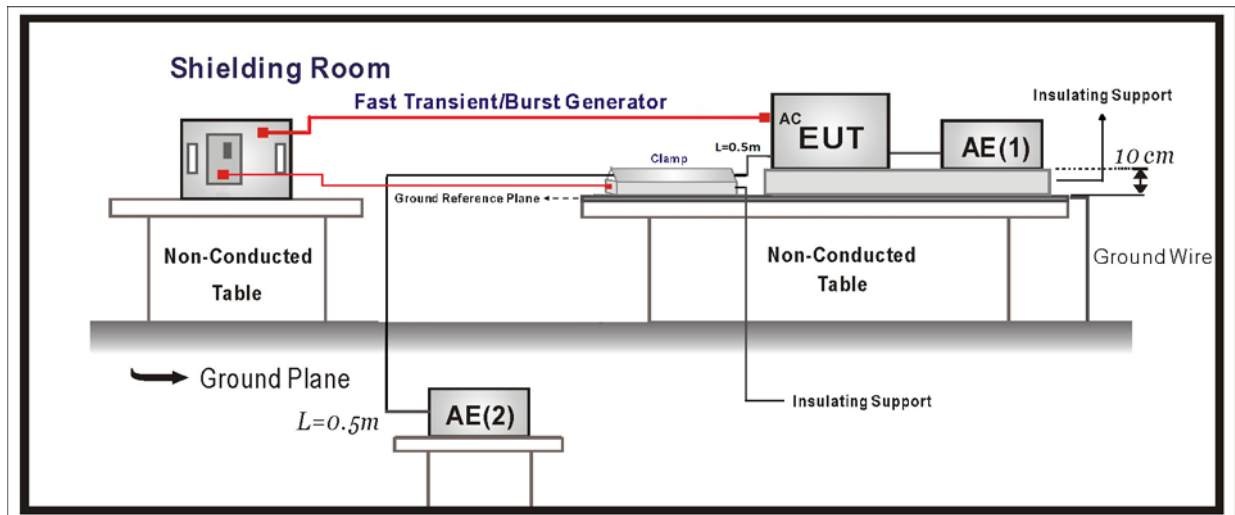

10.3. Limit

Item	Environmental Phenomena	Units	Test Specification	Performance Criteria
I/O and communication ports				
	Fast Transients Common Mode	kV (Peak) Tr/Th ns Rep. Frequency kHz	+0.5 5/50 5	B
Input DC Power Ports				
	Fast Transients Common Mode	kV (Peak) Tr/Th ns Rep. Frequency kHz	+0.5 5/50 5	B
Input AC Power Ports				
	Fast Transients Common Mode	kV (Peak) Tr/Th ns Rep. Frequency kHz	+1 5/50 5	B

Note:

1) For xDSL equipment, the repetition frequency for EFT testing shall be 100 kHz.

10.4. Test Procedure

The EUT is placed on a table that is 0.8 meter height. A ground reference plane is placed on the table, and uses a 0.1m insulation between the EUT and ground reference plane.

The minimum area of the ground reference plane is 1m*1m, and 0.65mm thick min, and projected beyond the EUT by at least 0.1m on all sides.

Test on I/O and communication ports:

The EFT interference signal is through a coupling clamp device couples to the signal and control lines of the EUT with burst noise for 1 minute.

Test on power supply ports:

The EUT is connected to the power mains through a coupling device that directly couples the EFT/B interference signal.

Each of the Line and Neutral conductors is impressed with burst noise for 1 minute.

The length of the signal and power lines between the coupling device and the EUT is 0.5m.

10.5. Deviation from Test Standard

No deviation.

10.6. Test Result

Product	Printer		
Test Item	Electrical fast transient/burst		
Test Mode	Mode 1: PC Printing (110W)		
Date of Test	2015/12/08	Test Site	SR1

Inject Line	Polarity	Voltage kV	Inject Time (Second)	Inject Method	Required Criteria	Complied to Criteria	Result
L	±	1	60	Direct	B	A	Pass
N	±	1	60	Direct	B	A	Pass
PE	±	1	60	Direct	B	A	Pass
L+N	±	1	60	Direct	B	A	Pass
L+PE	±	1	60	Direct	B	A	Pass
N+PE	±	1	60	Direct	B	A	Pass
L+N+PE	±	1	60	Direct	B	A	Pass

- Meet criteria A : Operate as intended during and after the test
- Meet criteria B : Operate as intended after the test
- Meet criteria C : Loss/Error of function
- Additional Information
 - EUT stopped operation and could / could not be reset by operator at _____ kV of Line _____.
 - No false alarms or other malfunctions were observed during or after the test.

Product	Printer		
Test Item	Electrical fast transient/burst		
Test Mode	Mode 2: LAN Printing (110W)		
Date of Test	2015/12/08	Test Site	SR1

Inject Line	Polarity	Voltage kV	Inject Time (Second)	Inject Method	Required Criteria	Complied to Criteria	Result
L	±	1	60	Direct	B	A	Pass
N	±	1	60	Direct	B	A	Pass
PE	±	1	60	Direct	B	A	Pass
L+N	±	1	60	Direct	B	A	Pass
L+PE	±	1	60	Direct	B	A	Pass
N+PE	±	1	60	Direct	B	A	Pass
L+N+PE	±	1	60	Direct	B	A	Pass
LAN Cable	±	0.5	60	Clamp	B	A	Pass

- Meet criteria A : Operate as intended during and after the test
- Meet criteria B : Operate as intended after the test
- Meet criteria C : Loss/Error of function
- Additional Information
 - EUT stopped operation and could / could not be reset by operator at _____ kV of Line _____.
 - No false alarms or other malfunctions were observed during or after the test.

Product	Printer		
Test Item	Electrical fast transient/burst		
Test Mode	Mode 3: Document Printing (110W)		
Date of Test	2015/12/08	Test Site	SR1

Inject Line	Polarity	Voltage kV	Inject Time (Second)	Inject Method	Required Criteria	Complied to Criteria	Result
L	±	1	60	Direct	B	A	Pass
N	±	1	60	Direct	B	A	Pass
PE	±	1	60	Direct	B	A	Pass
L+N	±	1	60	Direct	B	A	Pass
L+PE	±	1	60	Direct	B	A	Pass
N+PE	±	1	60	Direct	B	A	Pass
L+N+PE	±	1	60	Direct	B	A	Pass

- Meet criteria A : Operate as intended during and after the test
 Meet criteria B : Operate as intended after the test
 Meet criteria C : Loss/Error of function
 Additional Information
 EUT stopped operation and could / could not be reset by operator at _____ kV of
Line _____.
 No false alarms or other malfunctions were observed during or after the test.

Product	Printer		
Test Item	Electrical fast transient/burst		
Test Mode	Mode 4: WiFi Printing (110W)		
Date of Test	2016/04/08	Test Site	SR1

Inject Line	Polarity	Voltage kV	Inject Time (Second)	Inject Method	Required Criteria	Complied to Criteria	Result
L	±	1	60	Direct	B	A	Pass
N	±	1	60	Direct	B	A	Pass
PE	±	1	60	Direct	B	A	Pass
L+N	±	1	60	Direct	B	A	Pass
L+PE	±	1	60	Direct	B	A	Pass
N+PE	±	1	60	Direct	B	A	Pass
L+N+PE	±	1	60	Direct	B	A	Pass

- Meet criteria A : Operate as intended during and after the test
 Meet criteria B : Operate as intended after the test
 Meet criteria C : Loss/Error of function
 Additional Information
 EUT stopped operation and could / could not be reset by operator at _____ kV of Line _____.
 No false alarms or other malfunctions were observed during or after the test.

Product	Printer		
Test Item	Electrical fast transient/burst		
Test Mode	Mode 5: PC Printing (72W)		
Date of Test	2015/12/08	Test Site	SR1

Inject Line	Polarity	Voltage kV	Inject Time (Second)	Inject Method	Required Criteria	Complied to Criteria	Result
L	±	1	60	Direct	B	A	Pass
N	±	1	60	Direct	B	A	Pass
PE	±	1	60	Direct	B	A	Pass
L+N	±	1	60	Direct	B	A	Pass
L+PE	±	1	60	Direct	B	A	Pass
N+PE	±	1	60	Direct	B	A	Pass
L+N+PE	±	1	60	Direct	B	A	Pass

- Meet criteria A : Operate as intended during and after the test
- Meet criteria B : Operate as intended after the test
- Meet criteria C : Loss/Error of function
- Additional Information
 - EUT stopped operation and could / could not be reset by operator at _____ kV of Line _____.
 - No false alarms or other malfunctions were observed during or after the test.

Product	Printer		
Test Item	Electrical fast transient/burst		
Test Mode	Mode 6: LAN Printing (72W)		
Date of Test	2015/12/08	Test Site	SR1

Inject Line	Polarity	Voltage kV	Inject Time (Second)	Inject Method	Required Criteria	Complied to Criteria	Result
L	±	1	60	Direct	B	A	Pass
N	±	1	60	Direct	B	A	Pass
PE	±	1	60	Direct	B	A	Pass
L+N	±	1	60	Direct	B	A	Pass
L+PE	±	1	60	Direct	B	A	Pass
N+PE	±	1	60	Direct	B	A	Pass
L+N+PE	±	1	60	Direct	B	A	Pass
LAN Cable	±	0.5	60	Clamp	B	A	Pass

- Meet criteria A : Operate as intended during and after the test
- Meet criteria B : Operate as intended after the test
- Meet criteria C : Loss/Error of function
- Additional Information
 - EUT stopped operation and could / could not be reset by operator at _____ kV of Line _____.
 - No false alarms or other malfunctions were observed during or after the test.

Product	Printer		
Test Item	Electrical fast transient/burst		
Test Mode	Mode 7: Document Printing (72W)		
Date of Test	2015/12/08	Test Site	SR1

Inject Line	Polarity	Voltage kV	Inject Time (Second)	Inject Method	Required Criteria	Complied to Criteria	Result
L	±	1	60	Direct	B	A	Pass
N	±	1	60	Direct	B	A	Pass
PE	±	1	60	Direct	B	A	Pass
L+N	±	1	60	Direct	B	A	Pass
L+PE	±	1	60	Direct	B	A	Pass
N+PE	±	1	60	Direct	B	A	Pass
L+N+PE	±	1	60	Direct	B	A	Pass

- Meet criteria A : Operate as intended during and after the test
- Meet criteria B : Operate as intended after the test
- Meet criteria C : Loss/Error of function
- Additional Information
 - EUT stopped operation and could / could not be reset by operator at _____ kV of Line _____.
 - No false alarms or other malfunctions were observed during or after the test.

Product	Printer		
Test Item	Electrical fast transient/burst		
Test Mode	Mode 8: WiFi Printing (72W)		
Date of Test	2016/04/08	Test Site	SR1

Inject Line	Polarity	Voltage kV	Inject Time (Second)	Inject Method	Required Criteria	Complied to Criteria	Result
L	±	1	60	Direct	B	A	Pass
N	±	1	60	Direct	B	A	Pass
PE	±	1	60	Direct	B	A	Pass
L+N	±	1	60	Direct	B	A	Pass
L+PE	±	1	60	Direct	B	A	Pass
N+PE	±	1	60	Direct	B	A	Pass
L+N+PE	±	1	60	Direct	B	A	Pass

- Meet criteria A : Operate as intended during and after the test
- Meet criteria B : Operate as intended after the test
- Meet criteria C : Loss/Error of function
- Additional Information
 - EUT stopped operation and could / could not be reset by operator at _____ kV of Line _____.
 - No false alarms or other malfunctions were observed during or after the test.

10.7. Test Photograph

Test Mode : Mode 1: PC Printing (110W)

Description : Electrical Fast Transient/Burst (EFT/B) Test Setup



Test Mode : Mode 2: LAN Printing (110W)

Description : Electrical Fast Transient/Burst (EFT/B) Test Setup



Test Mode : Mode 2: LAN Printing (110W)

Description : Electrical Fast Transient/Burst (EFT/B) Test Setup-Clamp (LAN Cable)



Test Mode : Mode 3: Document Printing (110W)

Description : Electrical Fast Transient/Burst (EFT/B) Test Setup



Test Mode : Mode 4: WiFi Printing (110W)

Description : Electrical Fast Transient/Burst (EFT/B) Test Setup



Test Mode : Mode 5: PC Printing (72W)

Description : Electrical Fast Transient/Burst (EFT/B) Test Setup



Test Mode : Mode 6: LAN Printing (72W)

Description : Electrical Fast Transient/Burst (EFT/B) Test Setup



Test Mode : Mode 6: LAN Printing (72W)

Description : Electrical Fast Transient/Burst (EFT/B) Test Setup-Clamp (LAN Cable)



Test Mode : Mode 7: Document Printing (72W)

Description : Electrical Fast Transient/Burst (EFT/B) Test Setup



Test Mode : Mode 8: WiFi Printing (72W)

Description : Electrical Fast Transient/Burst (EFT/B) Test Setup



11. Surge

11.1. Test Specification

According to Standard : IEC 61000-4-5

11.2. Test Setup

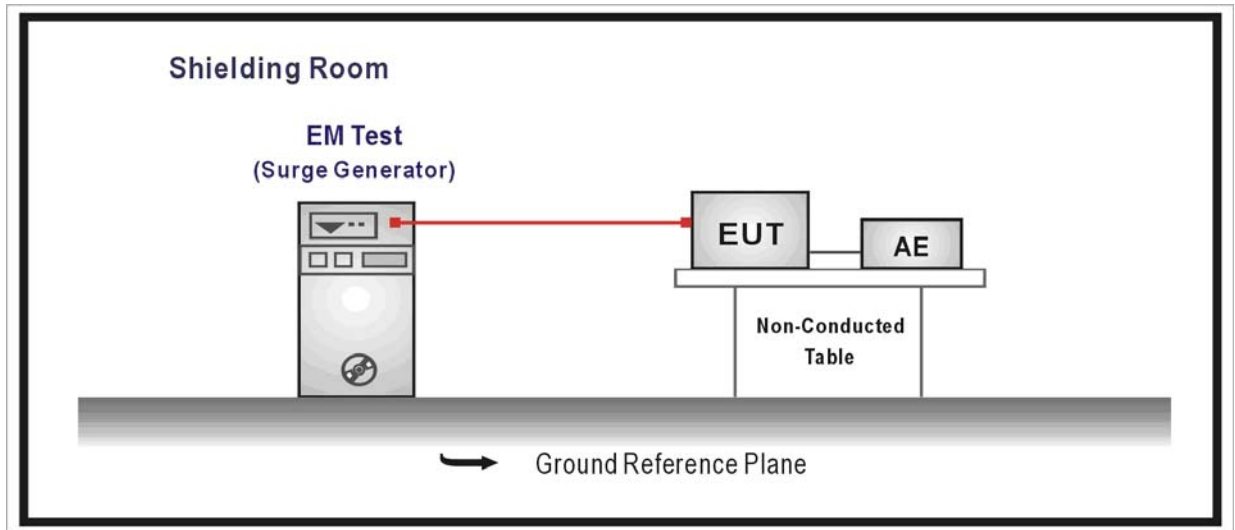

11.3. Limit

Item	Environmental Phenomena	Units	Test Specification	Performance Criteria
Signal Ports and Telecommunication Ports (See 1) and 2) and 3) and 4))				
Surges Line to Ground		Tr/Th us kV	10/700 ± 1	C
Input DC Power Ports				
Surges Line to Ground		Tr/Th us kV	1.2/50 (8/20) ± 0.5	B
AC Input and AC Output Power Ports				
Surges Line to Line Line to Ground		Tr/Th us kV kV	1.2/50 (8/20) ± 1 ± 2	B

Notes:

- 1) Applicable only to ports which according to the manufacturer's may directly to outdoor Cables.
- 2) Where normal functioning cannot be achieved because of the impact of the CDN on the EUT, no immunity test shall be required.
- 3) For ports where primary protection is intended, surges are applied at voltages up to 4 kV with the primary protectors fitted. Otherwise the 1 kV test level is applied without primary protection in place.
- 4) Where the coupling network for the 10/700 μ s waveform affects the functioning of high speed data ports, the test shall be carried out using a 1,2/50 (8/20) μ s waveform and appropriate coupling network.

11.4. Test Procedure

The EUT and its load are placed on a table that is 0.8 meter above a metal ground plane measured 1m*1m min. and 0.65mm thick min. And projected beyond the EUT by at least 0.1m on all sides. The length of power cord between the coupling device and the EUT shall be 2m or less.

For Input and Output AC Power or DC Input and DC Output Power Ports:

The EUT is connected to the power mains through a coupling device that directly couples the Surge interference signal.

The surge noise shall be applied synchronized to the voltage phase at 0° , 90° , 180° , 270° and the peak value of the a.c. voltage wave. (Positive and negative)

Each of Line-Earth and Line-Line is impressed with a sequence of five surge voltages with interval of 1 min.

11.5. Deviation from Test Standard

No deviation.

11.6. Test Result

Product	Printer		
Test Item	Surge		
Test Mode	Mode 1: PC Printing (110W)		
Date of Test	2015/12/16	Test Site	SR1

Inject Line	Polarity	Angle	Voltage kV	Time Interval (Second)	Inject Method	Required Criteria	Complied to Criteria	Result
L-N	±	0	1	60	Direct	B	A	Pass
L-N	±	90	1	60	Direct	B	A	Pass
L-N	±	180	1	60	Direct	B	A	Pass
L-N	±	270	1	60	Direct	B	A	Pass
N-PE	±	0	2	60	Direct	B	A	Pass
N-PE	±	90	2	60	Direct	B	A	Pass
N-PE	±	180	2	60	Direct	B	A	Pass
N-PE	±	270	2	60	Direct	B	A	Pass
L-PE	±	0	2	60	Direct	B	A	Pass
L-PE	±	90	2	60	Direct	B	A	Pass
L-PE	±	180	2	60	Direct	B	A	Pass
L-PE	±	270	2	60	Direct	B	A	Pass

- Meet criteria A : Operate as intended during and after the test
 Meet criteria B : Operate as intended after the test
 Meet criteria C : Loss/Error of function
 Additional Information
 EUT stopped operation and could / could not be reset by operator at _____ kV of Line _____.
 No false alarms or other malfunctions were observed during or after the test.

Product	Printer		
Test Item	Surge		
Test Mode	Mode 2: LAN Printing (110W)		
Date of Test	2015/12/16	Test Site	SR1

Inject Line	Polarity	Angle	Voltage kV	Time Interval (Second)	Inject Method	Required Criteria	Complied to Criteria	Result
L-N	±	0	1	60	Direct	B	A	Pass
L-N	±	90	1	60	Direct	B	A	Pass
L-N	±	180	1	60	Direct	B	A	Pass
L-N	±	270	1	60	Direct	B	A	Pass
N-PE	±	0	2	60	Direct	B	A	Pass
N-PE	±	90	2	60	Direct	B	A	Pass
N-PE	±	180	2	60	Direct	B	A	Pass
N-PE	±	270	2	60	Direct	B	A	Pass
L-PE	±	0	2	60	Direct	B	A	Pass
L-PE	±	90	2	60	Direct	B	A	Pass
L-PE	±	180	2	60	Direct	B	A	Pass
L-PE	±	270	2	60	Direct	B	A	Pass
LAN Cable	±	--	1	60	CDN	C	A	Pass

- Meet criteria A : Operate as intended during and after the test
- Meet criteria B : Operate as intended after the test
- Meet criteria C : Loss/Error of function
- Additional Information
 - EUT stopped operation and could / could not be reset by operator at _____ kV of Line _____.
 - No false alarms or other malfunctions were observed during or after the test.

Product	Printer		
Test Item	Surge		
Test Mode	Mode 3: Document Printing (110W)		
Date of Test	2015/12/16	Test Site	SR1

Inject Line	Polarity	Angle	Voltage kV	Time Interval (Second)	Inject Method	Required Criteria	Complied to Criteria	Result
L-N	±	0	1	60	Direct	B	A	Pass
L-N	±	90	1	60	Direct	B	A	Pass
L-N	±	180	1	60	Direct	B	A	Pass
L-N	±	270	1	60	Direct	B	A	Pass
N-PE	±	0	2	60	Direct	B	A	Pass
N-PE	±	90	2	60	Direct	B	A	Pass
N-PE	±	180	2	60	Direct	B	A	Pass
N-PE	±	270	2	60	Direct	B	A	Pass
L-PE	±	0	2	60	Direct	B	A	Pass
L-PE	±	90	2	60	Direct	B	A	Pass
L-PE	±	180	2	60	Direct	B	A	Pass
L-PE	±	270	2	60	Direct	B	A	Pass

- Meet criteria A : Operate as intended during and after the test
 Meet criteria B : Operate as intended after the test
 Meet criteria C : Loss/Error of function
 Additional Information
 EUT stopped operation and could / could not be reset by operator at _____ kV of Line _____.
 No false alarms or other malfunctions were observed during or after the test.

Product	Printer		
Test Item	Surge		
Test Mode	Mode 4: WiFi Printing (110W)		
Date of Test	2016/04/08	Test Site	SR1

Inject Line	Polarity	Angle	Voltage kV	Time Interval (Second)	Inject Method	Required Criteria	Complied to Criteria	Result
L-N	±	0	1	60	Direct	B	A	Pass
L-N	±	90	1	60	Direct	B	A	Pass
L-N	±	180	1	60	Direct	B	A	Pass
L-N	±	270	1	60	Direct	B	A	Pass
N-PE	±	0	2	60	Direct	B	A	Pass
N-PE	±	90	2	60	Direct	B	A	Pass
N-PE	±	180	2	60	Direct	B	A	Pass
N-PE	±	270	2	60	Direct	B	A	Pass
L-PE	±	0	2	60	Direct	B	A	Pass
L-PE	±	90	2	60	Direct	B	A	Pass
L-PE	±	180	2	60	Direct	B	A	Pass
L-PE	±	270	2	60	Direct	B	A	Pass

- Meet criteria A : Operate as intended during and after the test
- Meet criteria B : Operate as intended after the test
- Meet criteria C : Loss/Error of function
- Additional Information
 - EUT stopped operation and could / could not be reset by operator at _____ kV of Line _____.
 - No false alarms or other malfunctions were observed during or after the test.

Product	Printer		
Test Item	Surge		
Test Mode	Mode 5: PC Printing (72W)		
Date of Test	2015/12/16	Test Site	SR1

Inject Line	Polarity	Angle	Voltage kV	Time Interval (Second)	Inject Method	Required Criteria	Complied to Criteria	Result
L-N	±	0	1	60	Direct	B	A	Pass
L-N	±	90	1	60	Direct	B	A	Pass
L-N	±	180	1	60	Direct	B	A	Pass
L-N	±	270	1	60	Direct	B	A	Pass
N-PE	±	0	2	60	Direct	B	A	Pass
N-PE	±	90	2	60	Direct	B	A	Pass
N-PE	±	180	2	60	Direct	B	A	Pass
N-PE	±	270	2	60	Direct	B	A	Pass
L-PE	±	0	2	60	Direct	B	A	Pass
L-PE	±	90	2	60	Direct	B	A	Pass
L-PE	±	180	2	60	Direct	B	A	Pass
L-PE	±	270	2	60	Direct	B	A	Pass

- Meet criteria A : Operate as intended during and after the test
- Meet criteria B : Operate as intended after the test
- Meet criteria C : Loss/Error of function
- Additional Information
 - EUT stopped operation and could / could not be reset by operator at _____ kV of Line _____.
 - No false alarms or other malfunctions were observed during or after the test.

Product	Printer		
Test Item	Surge		
Test Mode	Mode 6: LAN Printing (72W)		
Date of Test	2015/12/16	Test Site	SR1

Inject Line	Polarity	Angle	Voltage kV	Time Interval (Second)	Inject Method	Required Criteria	Complied to Criteria	Result
L-N	±	0	1	60	Direct	B	A	Pass
L-N	±	90	1	60	Direct	B	A	Pass
L-N	±	180	1	60	Direct	B	A	Pass
L-N	±	270	1	60	Direct	B	A	Pass
N-PE	±	0	2	60	Direct	B	A	Pass
N-PE	±	90	2	60	Direct	B	A	Pass
N-PE	±	180	2	60	Direct	B	A	Pass
N-PE	±	270	2	60	Direct	B	A	Pass
L-PE	±	0	2	60	Direct	B	A	Pass
L-PE	±	90	2	60	Direct	B	A	Pass
L-PE	±	180	2	60	Direct	B	A	Pass
L-PE	±	270	2	60	Direct	B	A	Pass
LAN Cable	±	--	1	60	CDN	C	A	Pass

- Meet criteria A : Operate as intended during and after the test
- Meet criteria B : Operate as intended after the test
- Meet criteria C : Loss/Error of function
- Additional Information
 - EUT stopped operation and could / could not be reset by operator at _____ kV of Line _____.
 - No false alarms or other malfunctions were observed during or after the test.

Product	Printer		
Test Item	Surge		
Test Mode	Mode 7: Document Printing (72W)		
Date of Test	2015/12/16	Test Site	SR1

Inject Line	Polarity	Angle	Voltage kV	Time Interval (Second)	Inject Method	Required Criteria	Complied to Criteria	Result
L-N	±	0	1	60	Direct	B	A	Pass
L-N	±	90	1	60	Direct	B	A	Pass
L-N	±	180	1	60	Direct	B	A	Pass
L-N	±	270	1	60	Direct	B	A	Pass
N-PE	±	0	2	60	Direct	B	A	Pass
N-PE	±	90	2	60	Direct	B	A	Pass
N-PE	±	180	2	60	Direct	B	A	Pass
N-PE	±	270	2	60	Direct	B	A	Pass
L-PE	±	0	2	60	Direct	B	A	Pass
L-PE	±	90	2	60	Direct	B	A	Pass
L-PE	±	180	2	60	Direct	B	A	Pass
L-PE	±	270	2	60	Direct	B	A	Pass

- Meet criteria A : Operate as intended during and after the test
- Meet criteria B : Operate as intended after the test
- Meet criteria C : Loss/Error of function
- Additional Information
 - EUT stopped operation and could / could not be reset by operator at _____ kV of Line _____.
 - No false alarms or other malfunctions were observed during or after the test.

Remark:

1. The testing performed is from lowest level up to the highest level as required by standard, but only highest level is shown on the report.

Product	Printer		
Test Item	Surge		
Test Mode	Mode 8: WiFi Printing (72W)		
Date of Test	2016/04/08	Test Site	SR1

Inject Line	Polarity	Angle	Voltage kV	Time Interval (Second)	Inject Method	Required Criteria	Complied to Criteria	Result
L-N	±	0	1	60	Direct	B	A	Pass
L-N	±	90	1	60	Direct	B	A	Pass
L-N	±	180	1	60	Direct	B	A	Pass
L-N	±	270	1	60	Direct	B	A	Pass
N-PE	±	0	2	60	Direct	B	A	Pass
N-PE	±	90	2	60	Direct	B	A	Pass
N-PE	±	180	2	60	Direct	B	A	Pass
N-PE	±	270	2	60	Direct	B	A	Pass
L-PE	±	0	2	60	Direct	B	A	Pass
L-PE	±	90	2	60	Direct	B	A	Pass
L-PE	±	180	2	60	Direct	B	A	Pass
L-PE	±	270	2	60	Direct	B	A	Pass

- Meet criteria A : Operate as intended during and after the test
 Meet criteria B : Operate as intended after the test
 Meet criteria C : Loss/Error of function
 Additional Information
 EUT stopped operation and could / could not be reset by operator at _____ kV of Line _____.
 No false alarms or other malfunctions were observed during or after the test.

Remark:

- The testing performed is from lowest level up to the highest level as required by standard, but only highest level is shown on the report.

11.7. Test Photograph

Test Mode : Mode 1: PC Printing (110W)

Description : Surge Test Setup



Test Mode : Mode 2: LAN Printing (110W)

Description : Surge Test Setup



Test Mode : Mode 2: LAN Printing (110W)

Description : Surge Test Setup-CDN (LAN Cable)



Test Mode : Mode 3: Document Printing (110W)

Description : Surge Test Setup



Test Mode : Mode 4: WiFi Printing (110W)

Description : Surge Test Setup

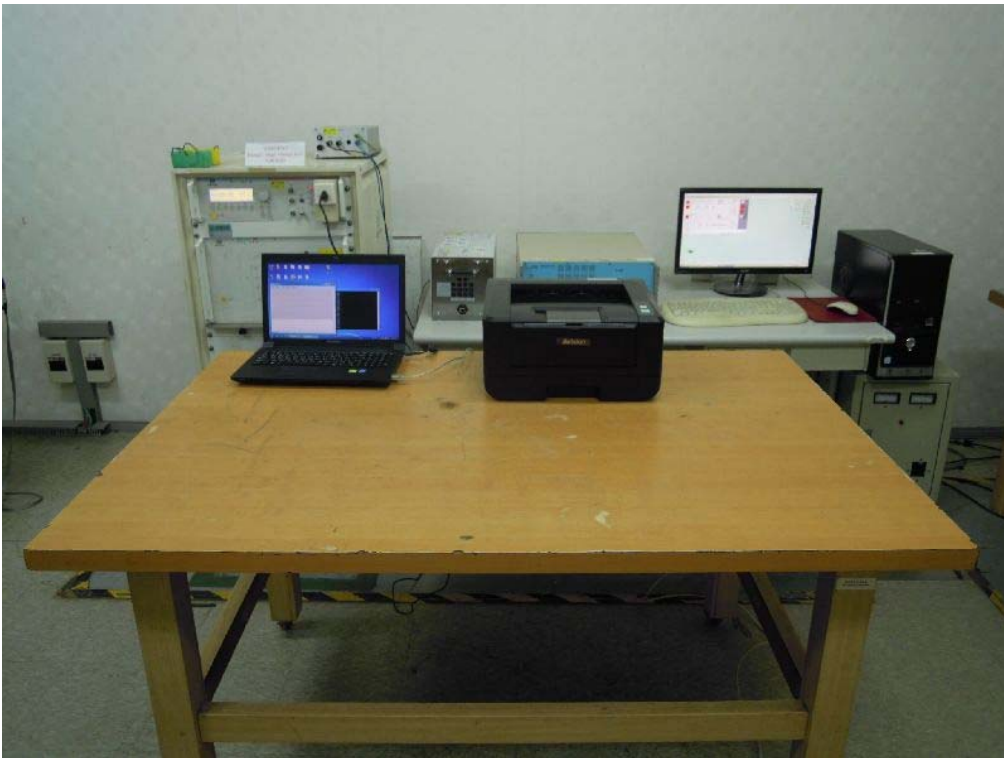

Test Mode : Mode 5: PC Printing (72W)

Description : Surge Test Setup



Test Mode : Mode 6: LAN Printing (72W)

Description : Surge Test Setup



Test Mode : Mode 6: LAN Printing (72W)

Description : Surge Test Setup-CDN (LAN Cable)



Test Mode : Mode 7: Document Printing (72W)

Description : Surge Test Setup



Test Mode : Mode 8: WiFi Printing (72W)

Description : Surge Test Setup



12. Conducted Susceptibility

12.1. Test Specification

According to Standard : IEC 61000-4-6

12.2. Test Setup

CDN Test Mode

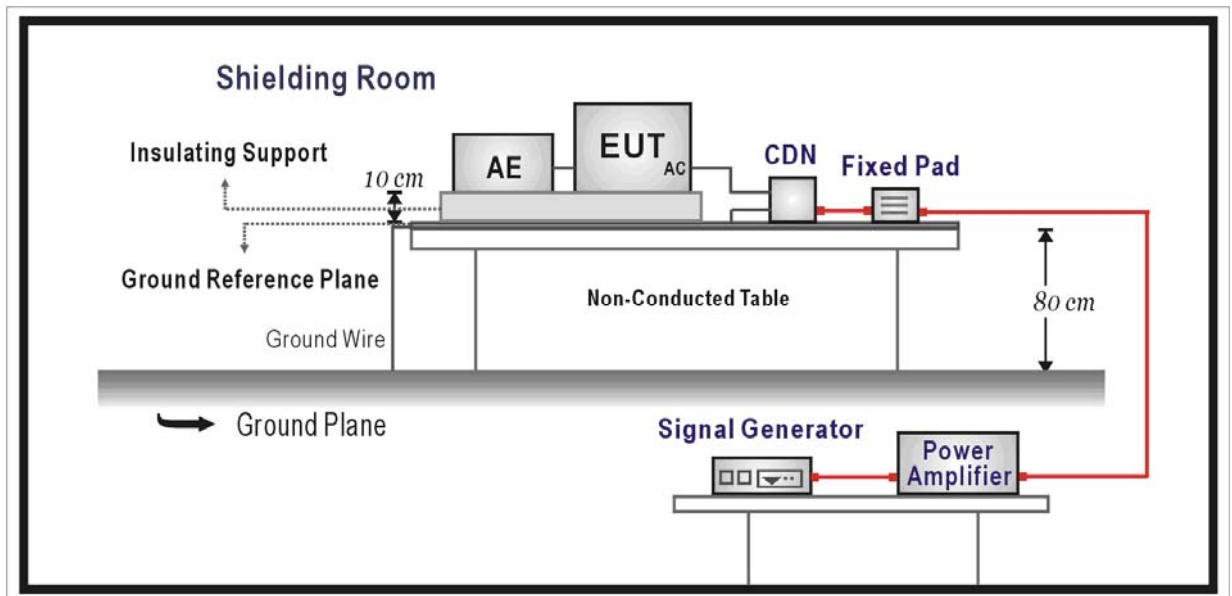

EM Clamp Test Mode

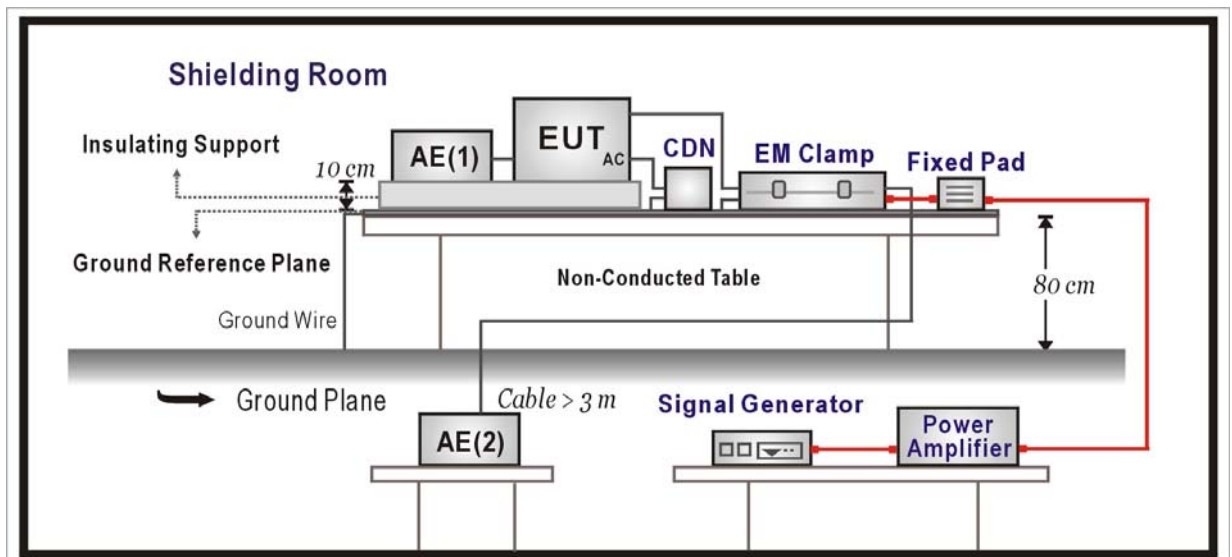

12.3. Limit

Item	Environmental Phenomena	Units	Test Specification	Performance Criteria
Signal Ports and Telecommunication Ports				
	Radio-Frequency Continuous Conducted	MHz V (rms, Un-modulated) % AM (1kHz)	0.15-80 3 80	A
Input DC Power Ports				
	Radio-Frequency Continuous Conducted	MHz V (rms, Un-modulated) % AM (1kHz)	0.15-80 3 80	A
Input AC Power Ports				
	Radio-Frequency Continuous Conducted	MHz V (rms, Un-modulated) % AM (1kHz)	0.15-80 3 80	A

12.4. Test Procedure

The EUT are placed on a table that is 0.8 meter height, and a Ground reference plane on the table, EUT are placed upon table and use a 10cm insulation between the EUT and Ground reference plane.

For Signal Ports and Telecommunication Ports

The disturbance signal is through a coupling and decoupling networks (CDN) or EM-clamp device couples to the signal and Telecommunication lines of the EUT.

For Input DC and AC Power Ports

The EUT is connected to the power mains through a coupling and decoupling networks for power supply lines. And directly couples the disturbances signal into EUT.

Used CDN-M2 for two wires or CDN-M3 for three wires.

All the scanning conditions are as follows:

Condition of Test	Remarks
1. Field Strength	3V Level 2
2. Radiated Signal	AM 80% Modulated with 1kHz
3. Scanning Frequency	0.15MHz – 80MHz
4 Dwell Time	3 Seconds
5. Frequency step size Δf :	1%

12.5. Deviation from Test Standard

No deviation.

12.6. Test Result

Product	Printer		
Test Item	Conducted susceptibility		
Test Mode	Mode 1: PC Printing (110W)		
Date of Test	2015/12/08	Test Site	SR4

Frequency Range (MHz)	Voltage Applied (V)	Inject Method	Tested Port of EUT	Required Criteria	Performance Criteria Complied To	Result
0.15~80	3	CDN	AC IN	A	A	Pass

- Meet criteria A : Operate as intended during and after the test
- Meet criteria B : Operate as intended after the test
- Meet criteria C : Loss/Error of function
- Additional Information
 - EUT stopped operation and could / could not be reset by operator at ____ dBuV(V) at frequency ____MHz.
 - No false alarms or other malfunctions were observed during or after the test. The acceptance criteria were met, and the EUT passed the test.

Product	Printer		
Test Item	Conducted susceptibility		
Test Mode	Mode 2: LAN Printing (110W)		
Date of Test	2015/12/08	Test Site	SR4

Frequency Range (MHz)	Voltage Applied (V)	Inject Method	Tested Port of EUT	Required Criteria	Performance Criteria Complied To	Result
0.15~80	3	CDN	AC IN	A	A	Pass
0.15~80	3	CDN	LAN Cable	A	A	Pass

- Meet criteria A : Operate as intended during and after the test
- Meet criteria B : Operate as intended after the test
- Meet criteria C : Loss/Error of function
- Additional Information
 - EUT stopped operation and could / could not be reset by operator at _____ dBuV(V) at frequency _____MHz.
 - No false alarms or other malfunctions were observed during or after the test. The acceptance criteria were met, and the EUT passed the test.

Product	Printer		
Test Item	Conducted susceptibility		
Test Mode	Mode 3: Document Printing (110W)		
Date of Test	2015/12/08	Test Site	SR4

Frequency Range (MHz)	Voltage Applied (V)	Inject Method	Tested Port of EUT	Required Criteria	Performance Criteria Complied To	Result
0.15~80	3	CDN	AC IN	A	A	Pass

- Meet criteria A : Operate as intended during and after the test
- Meet criteria B : Operate as intended after the test
- Meet criteria C : Loss/Error of function
- Additional Information
 - EUT stopped operation and could / could not be reset by operator at _____ dBuV(V) at frequency _____MHz.
 - No false alarms or other malfunctions were observed during or after the test. The acceptance criteria were met, and the EUT passed the test.

Product	Printer		
Test Item	Conducted susceptibility		
Test Mode	Mode 4: WiFi Printing (110W)		
Date of Test	2016/04/08	Test Site	SR4

Frequency Range (MHz)	Voltage Applied (V)	Inject Method	Tested Port of EUT	Required Criteria	Performance Criteria Complied To	Result
0.15~80	3	CDN	AC IN	A	A	Pass

- Meet criteria A : Operate as intended during and after the test
- Meet criteria B : Operate as intended after the test
- Meet criteria C : Loss/Error of function
- Additional Information
 - EUT stopped operation and could / could not be reset by operator at _____ dBuV(V) at frequency _____MHz.
 - No false alarms or other malfunctions were observed during or after the test. The acceptance criteria were met, and the EUT passed the test.

Product	Printer		
Test Item	Conducted susceptibility		
Test Mode	Mode 5: PC Printing (72W)		
Date of Test	2015/12/08	Test Site	SR4

Frequency Range (MHz)	Voltage Applied (V)	Inject Method	Tested Port of EUT	Required Criteria	Performance Criteria Complied To	Result
0.15~80	3	CDN	AC IN	A	A	Pass

- Meet criteria A : Operate as intended during and after the test
- Meet criteria B : Operate as intended after the test
- Meet criteria C : Loss/Error of function
- Additional Information
 - EUT stopped operation and could / could not be reset by operator at _____ dBuV(V) at frequency _____MHz.
 - No false alarms or other malfunctions were observed during or after the test. The acceptance criteria were met, and the EUT passed the test.

Product	Printer		
Test Item	Conducted susceptibility		
Test Mode	Mode 6: LAN Printing (72W)		
Date of Test	2015/12/08	Test Site	SR4

Frequency Range (MHz)	Voltage Applied (V)	Inject Method	Tested Port of EUT	Required Criteria	Performance Criteria Complied To	Result
0.15~80	3	CDN	AC IN	A	A	Pass
0.15~80	3	CDN	LAN Cable	A	A	Pass

- Meet criteria A : Operate as intended during and after the test
- Meet criteria B : Operate as intended after the test
- Meet criteria C : Loss/Error of function
- Additional Information
 - EUT stopped operation and could / could not be reset by operator at _____ dBuV(V) at frequency _____MHz.
 - No false alarms or other malfunctions were observed during or after the test. The acceptance criteria were met, and the EUT passed the test.

Product	Printer		
Test Item	Conducted susceptibility		
Test Mode	Mode 7: Document Printing (72W)		
Date of Test	2015/12/08	Test Site	SR4

Frequency Range (MHz)	Voltage Applied (V)	Inject Method	Tested Port of EUT	Required Criteria	Performance Criteria Complied To	Result
0.15~80	3	CDN	AC IN	A	A	Pass

- Meet criteria A : Operate as intended during and after the test
- Meet criteria B : Operate as intended after the test
- Meet criteria C : Loss/Error of function
- Additional Information
 - EUT stopped operation and could / could not be reset by operator at _____ dBuV(V) at frequency _____MHz.
 - No false alarms or other malfunctions were observed during or after the test. The acceptance criteria were met, and the EUT passed the test.

Product	Printer		
Test Item	Conducted susceptibility		
Test Mode	Mode 8: WiFi Printing (72W)		
Date of Test	2016/04/08	Test Site	SR4

Frequency Range (MHz)	Voltage Applied (V)	Inject Method	Tested Port of EUT	Required Criteria	Performance Criteria Complied To	Result
0.15~80	3	CDN	AC IN	A	A	Pass

- Meet criteria A : Operate as intended during and after the test
- Meet criteria B : Operate as intended after the test
- Meet criteria C : Loss/Error of function
- Additional Information
 - EUT stopped operation and could / could not be reset by operator at _____ dBuV(V) at frequency _____MHz.
 - No false alarms or other malfunctions were observed during or after the test. The acceptance criteria were met, and the EUT passed the test.

12.7. Test Photograph

Test Mode : Mode 1: PC Printing (110W)

Description : Conducted Susceptibility (CS) Test Setup



Test Mode : Mode 2: LAN Printing (110W)

Description : Conducted Susceptibility (CS) Test Setup

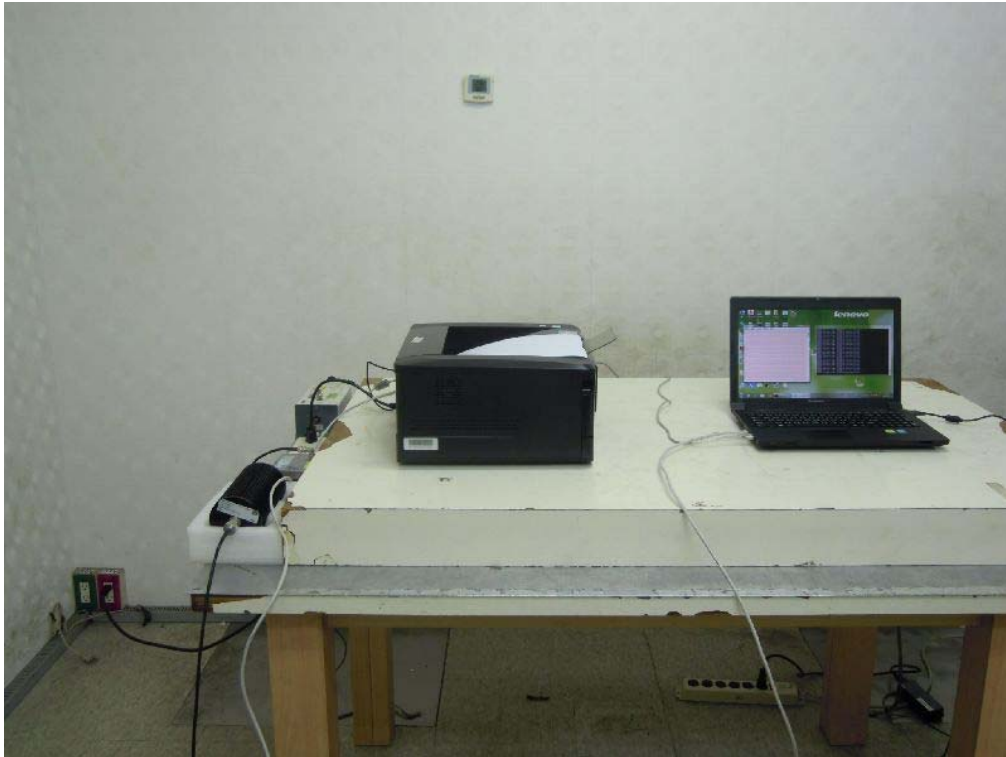

Test Mode : Mode 2: LAN Printing (110W)

Description : Conducted Susceptibility (CS) Test Setup-CDN (LAN Cable)

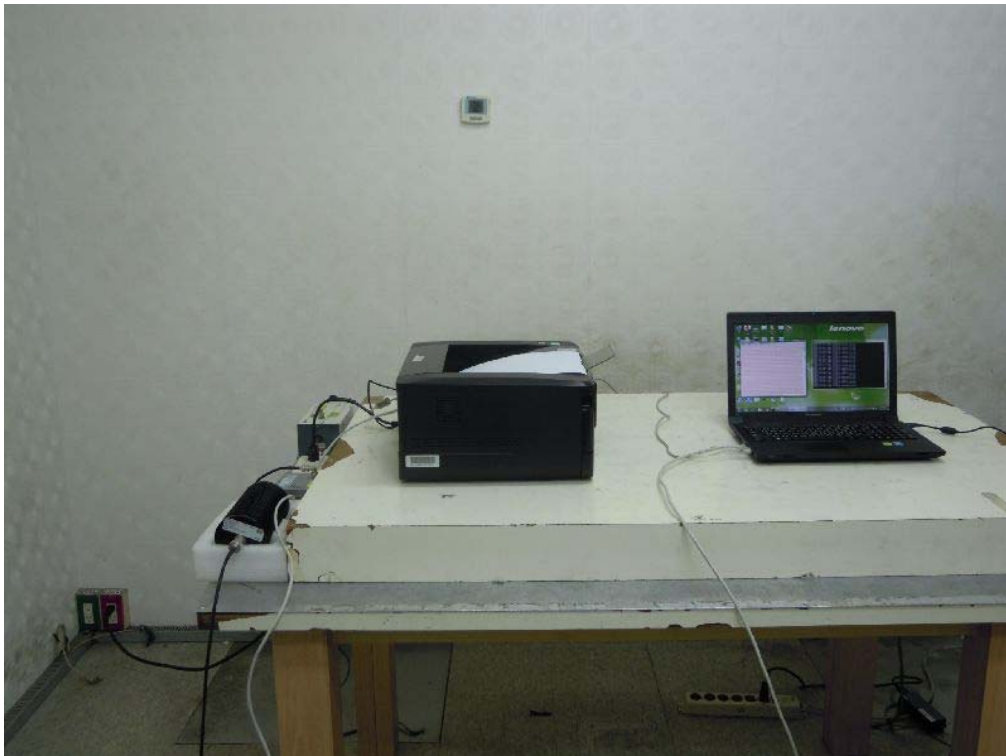

Test Mode : Mode 3: Document Printing (110W)

Description : Conducted Susceptibility (CS) Test Setup



Test Mode : Mode 4: WiFi Printing (110W)

Description : Conducted Susceptibility (CS) Test Setup



Test Mode : Mode 5: PC Printing (72W)

Description : Conducted Susceptibility (CS) Test Setup



Test Mode : Mode 6: LAN Printing (72W)

Description : Conducted Susceptibility (CS) Test Setup

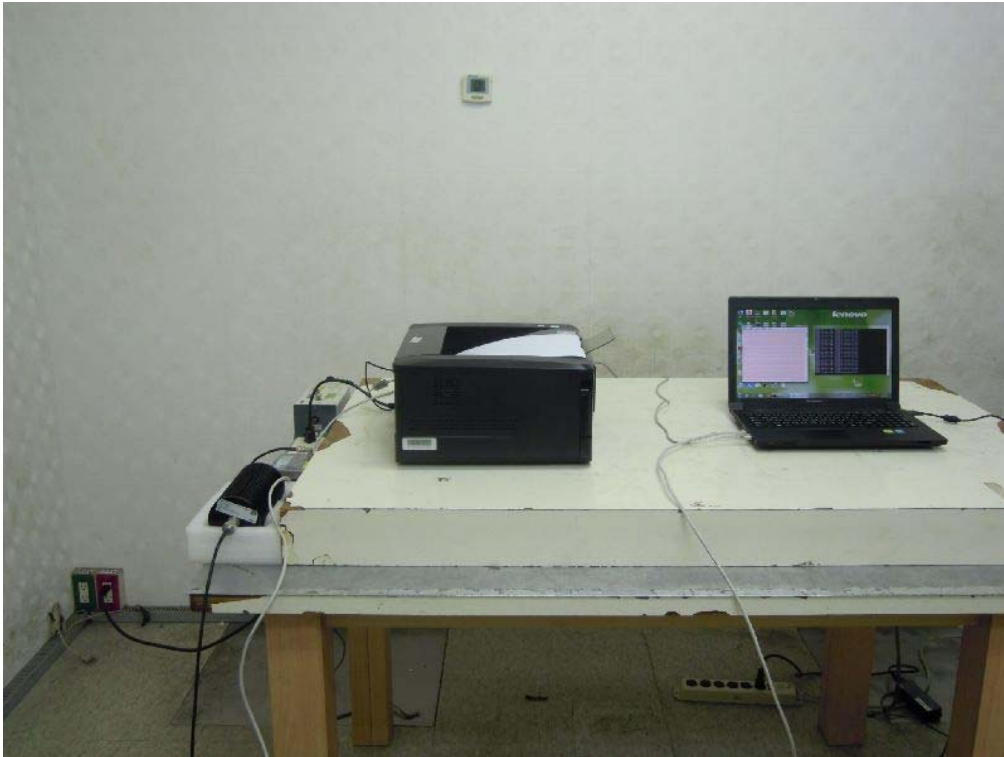

Test Mode : Mode 6: LAN Printing (72W)

Description : Conducted Susceptibility (CS) Test Setup-CDN (LAN Cable)

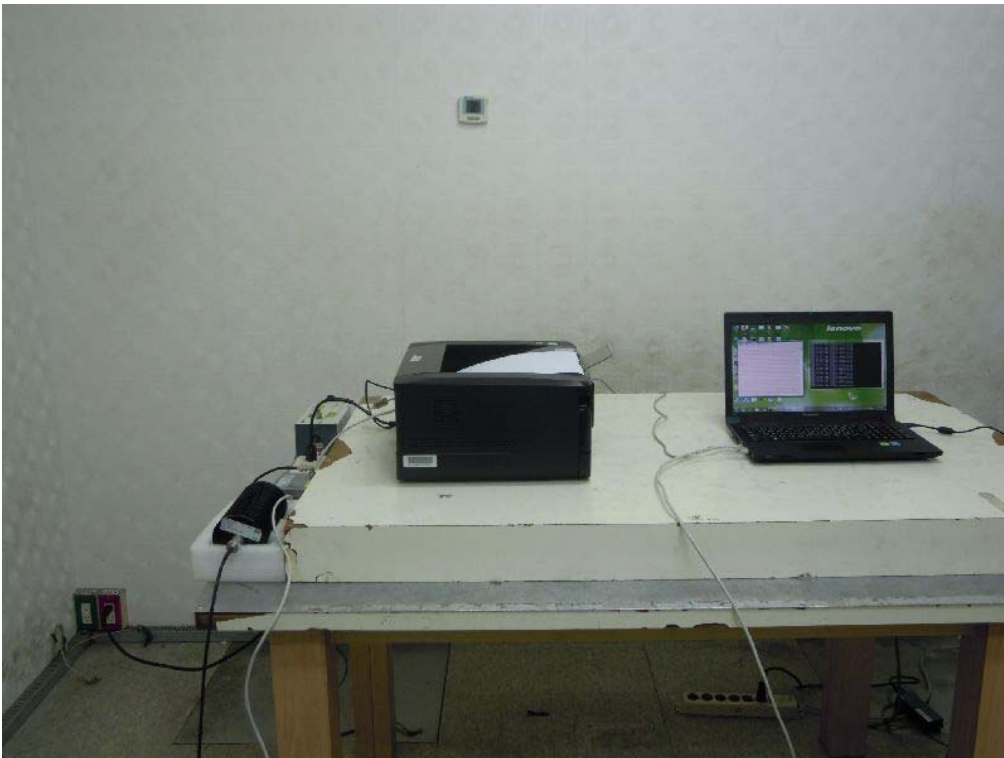

Test Mode : Mode 7: Document Printing (72W)

Description : Conducted Susceptibility (CS) Test Setup



Test Mode : Mode 8: WiFi Printing (72W)

Description : Conducted Susceptibility (CS) Test Setup



13. Power Frequency Magnetic Field

13.1. Test Specification

According to Standard : IEC 61000-4-8

13.2. Test Setup

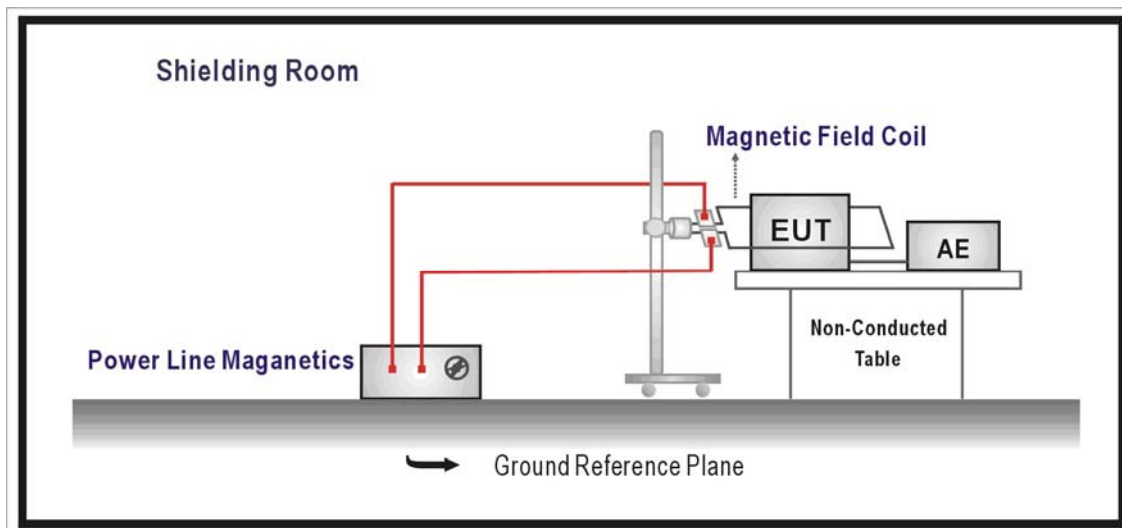

13.3. Limit

Item	Environmental Phenomena	Units	Test Specification	Performance Criteria
Enclosure Port				
	Power-Frequency Magnetic Field	Hz A/m (r.m.s.)	50 1	A

13.4. Test Procedure

The EUT and its load are placed on a table which is 0.8 meter above a metal ground plane measured at least 1m*1m min. The test magnetic field shall be placed at central of the induction coil.

The test magnetic Field shall be applied 1 minute by the immersion method to the EUT. And the induction coil shall be rotated by 90° in order to expose the EUT to the test field with different orientation (X, Y, Z Orientations).

13.5. Deviation from Test Standard

No deviation.

13.6. Test Result

Product	Printer		
Test Item	Power frequency magnetic field		
Test Mode	Mode 1: PC Printing (110W)		
Date of Test	2015/12/08	Test Site	SR1

Polarization	Frequency (Hz)	Magnetic Strength (A/m)	Required Performance Criteria	Performance Criteria Complied To	Test Result
X Orientation	50	1	A	A	Pass
Y Orientation	50	1	A	A	Pass
Z Orientation	50	1	A	A	Pass

- Meet criteria A : Operate as intended during and after the test
- Meet criteria B : Operate as intended after the test
- Meet criteria C : Loss/Error of function
- Additional Information
 - EUT stopped operation and could / could not be reset by operator at _____ A/m.
 - No false alarms or other malfunctions were observed during or after the test. The acceptance criteria were met, and the EUT passed the test.

Product	Printer		
Test Item	Power frequency magnetic field		
Test Mode	Mode 2: LAN Printing (110W)		
Date of Test	2015/12/08	Test Site	SR1

Polarization	Frequency (Hz)	Magnetic Strength (A/m)	Required Performance Criteria	Performance Criteria Complied To	Test Result
X Orientation	50	1	A	A	Pass
Y Orientation	50	1	A	A	Pass
Z Orientation	50	1	A	A	Pass

- Meet criteria A : Operate as intended during and after the test
- Meet criteria B : Operate as intended after the test
- Meet criteria C : Loss/Error of function
- Additional Information
 - EUT stopped operation and could / could not be reset by operator at _____ A/m.
 - No false alarms or other malfunctions were observed during or after the test. The acceptance criteria were met, and the EUT passed the test.

Product	Printer		
Test Item	Power frequency magnetic field		
Test Mode	Mode 3: Document Printing (110W)		
Date of Test	2015/12/08	Test Site	SR1

Polarization	Frequency (Hz)	Magnetic Strength (A/m)	Required Performance Criteria	Performance Criteria Complied To	Test Result
X Orientation	50	1	A	A	Pass
Y Orientation	50	1	A	A	Pass
Z Orientation	50	1	A	A	Pass

- Meet criteria A : Operate as intended during and after the test
- Meet criteria B : Operate as intended after the test
- Meet criteria C : Loss/Error of function
- Additional Information
 - EUT stopped operation and could / could not be reset by operator at _____ A/m.
 - No false alarms or other malfunctions were observed during or after the test. The acceptance criteria were met, and the EUT passed the test.

Product	Printer		
Test Item	Power frequency magnetic field		
Test Mode	Mode 4: WiFi Printing (110W)		
Date of Test	2016/04/11	Test Site	SR1

Polarization	Frequency (Hz)	Magnetic Strength (A/m)	Required Performance Criteria	Performance Criteria Complied To	Test Result
X Orientation	50	1	A	A	Pass
Y Orientation	50	1	A	A	Pass
Z Orientation	50	1	A	A	Pass

- Meet criteria A : Operate as intended during and after the test
- Meet criteria B : Operate as intended after the test
- Meet criteria C : Loss/Error of function
- Additional Information
 - EUT stopped operation and could / could not be reset by operator at _____ A/m.
 - No false alarms or other malfunctions were observed during or after the test. The acceptance criteria were met, and the EUT passed the test.

Product	Printer		
Test Item	Power frequency magnetic field		
Test Mode	Mode 5: PC Printing (72W)		
Date of Test	2015/12/08	Test Site	SR1

Polarization	Frequency (Hz)	Magnetic Strength (A/m)	Required Performance Criteria	Performance Criteria Complied To	Test Result
X Orientation	50	1	A	A	Pass
Y Orientation	50	1	A	A	Pass
Z Orientation	50	1	A	A	Pass

- Meet criteria A : Operate as intended during and after the test
- Meet criteria B : Operate as intended after the test
- Meet criteria C : Loss/Error of function
- Additional Information
 - EUT stopped operation and could / could not be reset by operator at _____ A/m.
 - No false alarms or other malfunctions were observed during or after the test. The acceptance criteria were met, and the EUT passed the test.

Product	Printer		
Test Item	Power frequency magnetic field		
Test Mode	Mode 6: LAN Printing (72W)		
Date of Test	2015/12/08	Test Site	SR1

Polarization	Frequency (Hz)	Magnetic Strength (A/m)	Required Performance Criteria	Performance Criteria Complied To	Test Result
X Orientation	50	1	A	A	Pass
Y Orientation	50	1	A	A	Pass
Z Orientation	50	1	A	A	Pass

- Meet criteria A : Operate as intended during and after the test
- Meet criteria B : Operate as intended after the test
- Meet criteria C : Loss/Error of function
- Additional Information
 - EUT stopped operation and could / could not be reset by operator at _____ A/m.
 - No false alarms or other malfunctions were observed during or after the test. The acceptance criteria were met, and the EUT passed the test.

Product	Printer		
Test Item	Power frequency magnetic field		
Test Mode	Mode 7: Document Printing (72W)		
Date of Test	2015/12/08	Test Site	SR1

Polarization	Frequency (Hz)	Magnetic Strength (A/m)	Required Performance Criteria	Performance Criteria Complied To	Test Result
X Orientation	50	1	A	A	Pass
Y Orientation	50	1	A	A	Pass
Z Orientation	50	1	A	A	Pass

- Meet criteria A : Operate as intended during and after the test
- Meet criteria B : Operate as intended after the test
- Meet criteria C : Loss/Error of function
- Additional Information
 - EUT stopped operation and could / could not be reset by operator at _____ A/m.
 - No false alarms or other malfunctions were observed during or after the test. The acceptance criteria were met, and the EUT passed the test.

Product	Printer		
Test Item	Power frequency magnetic field		
Test Mode	Mode 8: WiFi Printing (72W)		
Date of Test	2016/04/08	Test Site	SR1

Polarization	Frequency (Hz)	Magnetic Strength (A/m)	Required Performance Criteria	Performance Criteria Complied To	Test Result
X Orientation	50	1	A	A	Pass
Y Orientation	50	1	A	A	Pass
Z Orientation	50	1	A	A	Pass

- Meet criteria A : Operate as intended during and after the test
- Meet criteria B : Operate as intended after the test
- Meet criteria C : Loss/Error of function
- Additional Information
 - EUT stopped operation and could / could not be reset by operator at _____ A/m.
 - No false alarms or other malfunctions were observed during or after the test. The acceptance criteria were met, and the EUT passed the test.

13.7. Test Photograph

Test Mode : Mode 1: PC Printing (110W)

Description : Power Frequency Magnetic Field Test Setup



Test Mode : Mode 2: LAN Printing (110W)

Description : Power Frequency Magnetic Field Test Setup



Test Mode : Mode 3: Document Printing (110W)

Description : Power Frequency Magnetic Field Test Setup



Test Mode : Mode 4: WiFi Printing (110W)

Description : Power Frequency Magnetic Field Test Setup

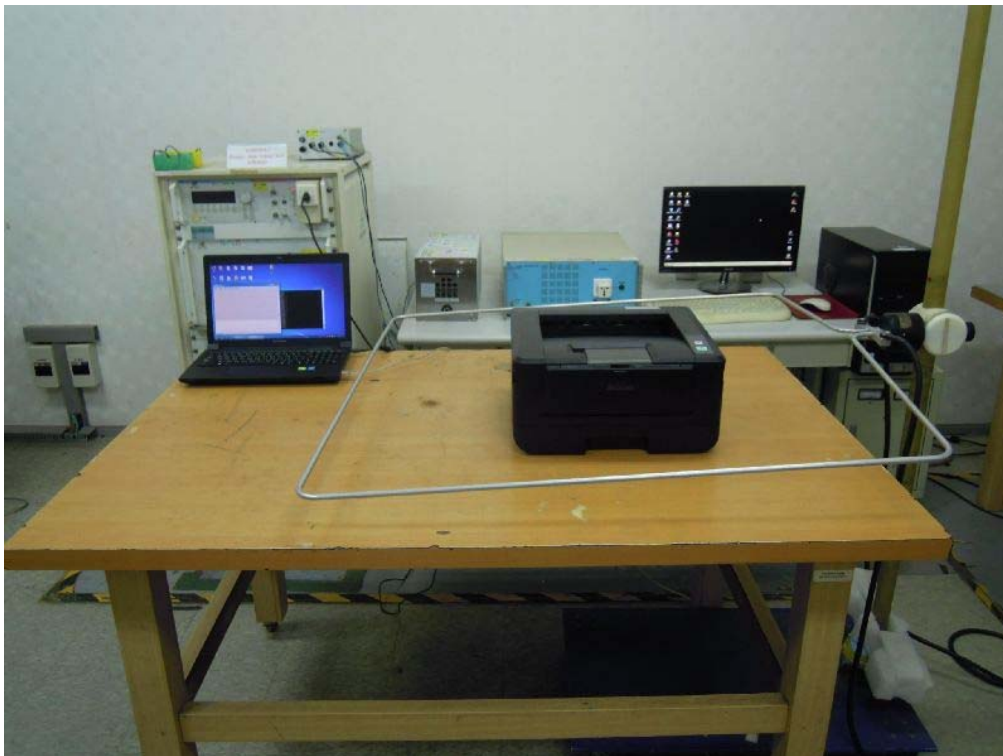

Test Mode : Mode 5: PC Printing (72W)

Description : Power Frequency Magnetic Field Test Setup



Test Mode : Mode 6: LAN Printing (72W)

Description : Power Frequency Magnetic Field Test Setup



Test Mode : Mode 7: Document Printing (72W)

Description : Power Frequency Magnetic Field Test Setup



Test Mode : Mode 8: WiFi Printing (72W)

Description : Power Frequency Magnetic Field Test Setup



14. Voltage Dips and Interruption

14.1. Test Specification

According to Standard : IEC 61000-4-11

14.2. Test Setup

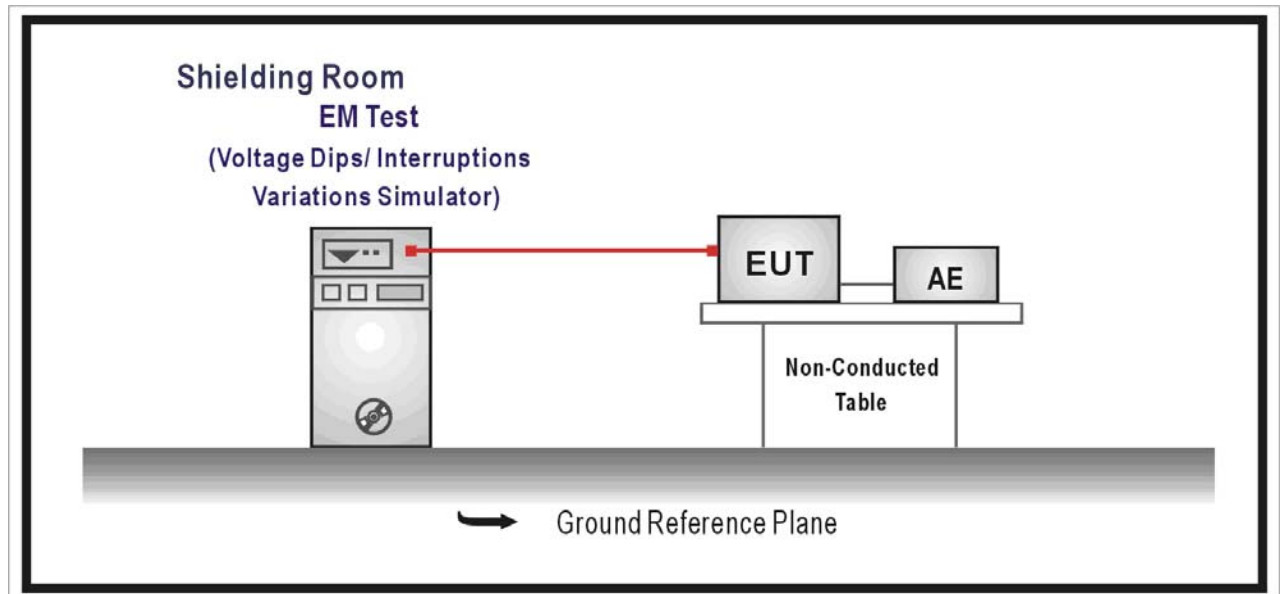

14.3. Limit

Item	Environmental Phenomena	Units	Test Specification	Performance Criteria
Input AC Power Ports				
	Voltage Dips	% Reduction	30	C
		Period	25	
	Voltage Interruptions	% Reduction	>95	B
		Period	0.5	
	Voltage Interruptions	% Reduction	>95	C
		Period	250	

14.4. Test Procedure

The EUT and its load are placed on a table which is 0.8 meter above a metal ground plane measured 1m*1m min. And 0.65mm thick min. And projected beyond the EUT by at least 0.1m on all sides. The power cord shall be used the shortest power cord as specified by the manufacturer.

For Voltage Dips/ Interruptions test:

The selection of test voltage is based on the rated power range. If the operation range is large than 20% of lower power range, both end of specified voltage shall be tested.

Otherwise, the typical voltage specification is selected as test voltage.

The EUT is connected to the power mains through a coupling device that directly couples to the Voltage Dips and Interruption Generator.

The EUT shall be tested for 30% voltage dip of supplied voltage and duration 25 Periods, for 95% voltage dip of supplied voltage and duration 0.5 Periods with a sequence of three voltage dips with intervals of 10 seconds, and for 95% voltage interruption of supplied voltage and duration 250 Periods with a sequence of three voltage interruptions with intervals of 10 seconds.

Voltage phase shifting are shall occur at 0° , 45° , 90° , 135° , 180° , 225° , 270° , 315° of the voltage.

14.5. Deviation from Test Standard

No deviation.

14.6. Test Result

Product	Printer		
Test Item	Voltage dips and interruption		
Test Mode	Mode 1: PC Printing (110W)		
Date of Test	2015/12/16	Test Site	SR1

Voltage Dips and Interruption Reduction(%)	Angle	Test Duration (Periods)	Required Performance Criteria	Performance Criteria Complied To	Test Result
30	0	25	C	A	Pass
30	45	25	C	A	Pass
30	90	25	C	A	Pass
30	135	25	C	A	Pass
30	180	25	C	A	Pass
30	225	25	C	A	Pass
30	270	25	C	A	Pass
30	315	25	C	A	Pass
>95	0	0.5	B	A	Pass
>95	45	0.5	B	A	Pass
>95	90	0.5	B	A	Pass
>95	135	0.5	B	A	Pass
>95	180	0.5	B	A	Pass
>95	225	0.5	B	A	Pass
>95	270	0.5	B	A	Pass
>95	315	0.5	B	A	Pass
>95	0	250	C	C	Pass
>95	45	250	C	C	Pass
>95	90	250	C	C	Pass
>95	135	250	C	C	Pass
>95	180	250	C	C	Pass
>95	225	250	C	C	Pass
>95	270	250	C	C	Pass
>95	315	250	C	C	Pass

- Meet criteria A : Operate as intended during and after the test
- Meet criteria B : Operate as intended after the test
- Meet criteria C : Loss/Error of function
- Additional Information
 - The nominal voltage of EUT is 230V.
 - EUT stopped operation and could / could not be reset by operator at _____.
 - No false alarms or other malfunctions were observed during or after the test. The acceptance criteria were met, and the EUT passed the test.

Product	Printer		
Test Item	Voltage dips and interruption		
Test Mode	Mode 2: LAN Printing (110W)		
Date of Test	2015/12/16	Test Site	SR1

Voltage Dips and Interruption Reduction(%)	Angle	Test Duration (Periods)	Required Performance Criteria	Performance Criteria Complied To	Test Result
30	0	25	C	A	Pass
30	45	25	C	A	Pass
30	90	25	C	A	Pass
30	135	25	C	A	Pass
30	180	25	C	A	Pass
30	225	25	C	A	Pass
30	270	25	C	A	Pass
30	315	25	C	A	Pass
>95	0	0.5	B	A	Pass
>95	45	0.5	B	A	Pass
>95	90	0.5	B	A	Pass
>95	135	0.5	B	A	Pass
>95	180	0.5	B	A	Pass
>95	225	0.5	B	A	Pass
>95	270	0.5	B	A	Pass
>95	315	0.5	B	A	Pass
>95	0	250	C	C	Pass
>95	45	250	C	C	Pass
>95	90	250	C	C	Pass
>95	135	250	C	C	Pass
>95	180	250	C	C	Pass
>95	225	250	C	C	Pass
>95	270	250	C	C	Pass
>95	315	250	C	C	Pass

- Meet criteria A : Operate as intended during and after the test
- Meet criteria B : Operate as intended after the test
- Meet criteria C : Loss/Error of function
- Additional Information
 - The nominal voltage of EUT is 230V.
 - EUT stopped operation and could / could not be reset by operator at _____.
 - No false alarms or other malfunctions were observed during or after the test. The acceptance criteria were met, and the EUT passed the test.

Product	Printer		
Test Item	Voltage dips and interruption		
Test Mode	Mode 3: Document Printing (110W)		
Date of Test	2015/12/16	Test Site	SR1

Voltage Dips and Interruption Reduction(%)	Angle	Test Duration (Periods)	Required Performance Criteria	Performance Criteria Complied To	Test Result
30	0	25	C	A	Pass
30	45	25	C	A	Pass
30	90	25	C	A	Pass
30	135	25	C	A	Pass
30	180	25	C	A	Pass
30	225	25	C	A	Pass
30	270	25	C	A	Pass
30	315	25	C	A	Pass
>95	0	0.5	B	A	Pass
>95	45	0.5	B	A	Pass
>95	90	0.5	B	A	Pass
>95	135	0.5	B	A	Pass
>95	180	0.5	B	A	Pass
>95	225	0.5	B	A	Pass
>95	270	0.5	B	A	Pass
>95	315	0.5	B	A	Pass
>95	0	250	C	C	Pass
>95	45	250	C	C	Pass
>95	90	250	C	C	Pass
>95	135	250	C	C	Pass
>95	180	250	C	C	Pass
>95	225	250	C	C	Pass
>95	270	250	C	C	Pass
>95	315	250	C	C	Pass

- Meet criteria A : Operate as intended during and after the test
 Meet criteria B : Operate as intended after the test
 Meet criteria C : Loss/Error of function
 Additional Information
 The nominal voltage of EUT is 230V.
 EUT stopped operation and could / could not be reset by operator at _____.
 No false alarms or other malfunctions were observed during or after the test. The acceptance criteria were met, and the EUT passed the test.

Product	Printer		
Test Item	Voltage dips and interruption		
Test Mode	Mode 4: WiFi Printing (110W)		
Date of Test	2016/04/11	Test Site	SR1

Voltage Dips and Interruption Reduction(%)	Angle	Test Duration (Periods)	Required Performance Criteria	Performance Criteria Complied To	Test Result
30	0	25	C	A	Pass
30	45	25	C	A	Pass
30	90	25	C	A	Pass
30	135	25	C	A	Pass
30	180	25	C	A	Pass
30	225	25	C	A	Pass
30	270	25	C	A	Pass
30	315	25	C	A	Pass
>95	0	0.5	B	A	Pass
>95	45	0.5	B	A	Pass
>95	90	0.5	B	A	Pass
>95	135	0.5	B	A	Pass
>95	180	0.5	B	A	Pass
>95	225	0.5	B	A	Pass
>95	270	0.5	B	A	Pass
>95	315	0.5	B	A	Pass
>95	0	250	C	C	Pass
>95	45	250	C	C	Pass
>95	90	250	C	C	Pass
>95	135	250	C	C	Pass
>95	180	250	C	C	Pass
>95	225	250	C	C	Pass
>95	270	250	C	C	Pass
>95	315	250	C	C	Pass

- Meet criteria A : Operate as intended during and after the test
- Meet criteria B : Operate as intended after the test
- Meet criteria C : Loss/Error of function
- Additional Information
 - The nominal voltage of EUT is 230V.
 - EUT stopped operation and could / could not be reset by operator at _____.
 - No false alarms or other malfunctions were observed during or after the test. The acceptance criteria were met, and the EUT passed the test.

Product	Printer		
Test Item	Voltage dips and interruption		
Test Mode	Mode 5: PC Printing (72W)		
Date of Test	2015/12/16	Test Site	SR1

Voltage Dips and Interruption Reduction(%)	Angle	Test Duration (Periods)	Required Performance Criteria	Performance Criteria Complied To	Test Result
30	0	25	C	A	Pass
30	45	25	C	A	Pass
30	90	25	C	A	Pass
30	135	25	C	A	Pass
30	180	25	C	A	Pass
30	225	25	C	A	Pass
30	270	25	C	A	Pass
30	315	25	C	A	Pass
>95	0	0.5	B	A	Pass
>95	45	0.5	B	A	Pass
>95	90	0.5	B	A	Pass
>95	135	0.5	B	A	Pass
>95	180	0.5	B	A	Pass
>95	225	0.5	B	A	Pass
>95	270	0.5	B	A	Pass
>95	315	0.5	B	A	Pass
>95	0	250	C	C	Pass
>95	45	250	C	C	Pass
>95	90	250	C	C	Pass
>95	135	250	C	C	Pass
>95	180	250	C	C	Pass
>95	225	250	C	C	Pass
>95	270	250	C	C	Pass
>95	315	250	C	C	Pass

- Meet criteria A : Operate as intended during and after the test
- Meet criteria B : Operate as intended after the test
- Meet criteria C : Loss/Error of function
- Additional Information
 - The nominal voltage of EUT is 230V.
 - EUT stopped operation and could / could not be reset by operator at _____.
 - No false alarms or other malfunctions were observed during or after the test. The acceptance criteria were met, and the EUT passed the test.

Product	Printer		
Test Item	Voltage dips and interruption		
Test Mode	Mode 6: LAN Printing (72W)		
Date of Test	2015/12/16	Test Site	SR1

Voltage Dips and Interruption Reduction(%)	Angle	Test Duration (Periods)	Required Performance Criteria	Performance Criteria Complied To	Test Result
30	0	25	C	A	Pass
30	45	25	C	A	Pass
30	90	25	C	A	Pass
30	135	25	C	A	Pass
30	180	25	C	A	Pass
30	225	25	C	A	Pass
30	270	25	C	A	Pass
30	315	25	C	A	Pass
>95	0	0.5	B	A	Pass
>95	45	0.5	B	A	Pass
>95	90	0.5	B	A	Pass
>95	135	0.5	B	A	Pass
>95	180	0.5	B	A	Pass
>95	225	0.5	B	A	Pass
>95	270	0.5	B	A	Pass
>95	315	0.5	B	A	Pass
>95	0	250	C	C	Pass
>95	45	250	C	C	Pass
>95	90	250	C	C	Pass
>95	135	250	C	C	Pass
>95	180	250	C	C	Pass
>95	225	250	C	C	Pass
>95	270	250	C	C	Pass
>95	315	250	C	C	Pass

- Meet criteria A : Operate as intended during and after the test
- Meet criteria B : Operate as intended after the test
- Meet criteria C : Loss/Error of function
- Additional Information
 - The nominal voltage of EUT is 230V.
 - EUT stopped operation and could / could not be reset by operator at _____.
 - No false alarms or other malfunctions were observed during or after the test. The acceptance criteria were met, and the EUT passed the test.

Product	Printer		
Test Item	Voltage dips and interruption		
Test Mode	Mode 7: Document Printing (72W)		
Date of Test	2015/12/16	Test Site	SR1

Voltage Dips and Interruption Reduction(%)	Angle	Test Duration (Periods)	Required Performance Criteria	Performance Criteria Complied To	Test Result
30	0	25	C	A	Pass
30	45	25	C	A	Pass
30	90	25	C	A	Pass
30	135	25	C	A	Pass
30	180	25	C	A	Pass
30	225	25	C	A	Pass
30	270	25	C	A	Pass
30	315	25	C	A	Pass
>95	0	0.5	B	A	Pass
>95	45	0.5	B	A	Pass
>95	90	0.5	B	A	Pass
>95	135	0.5	B	A	Pass
>95	180	0.5	B	A	Pass
>95	225	0.5	B	A	Pass
>95	270	0.5	B	A	Pass
>95	315	0.5	B	A	Pass
>95	0	250	C	C	Pass
>95	45	250	C	C	Pass
>95	90	250	C	C	Pass
>95	135	250	C	C	Pass
>95	180	250	C	C	Pass
>95	225	250	C	C	Pass
>95	270	250	C	C	Pass
>95	315	250	C	C	Pass

- Meet criteria A : Operate as intended during and after the test
- Meet criteria B : Operate as intended after the test
- Meet criteria C : Loss/Error of function
- Additional Information
 - The nominal voltage of EUT is 230V.
 - EUT stopped operation and could / could not be reset by operator at _____.
 - No false alarms or other malfunctions were observed during or after the test. The acceptance criteria were met, and the EUT passed the test.

Product	Printer		
Test Item	Voltage dips and interruption		
Test Mode	Mode 8: WiFi Printing (72W)		
Date of Test	2016/04/11	Test Site	SR1

Voltage Dips and Interruption Reduction(%)	Angle	Test Duration (Periods)	Required Performance Criteria	Performance Criteria Complied To	Test Result
30	0	25	C	A	Pass
30	45	25	C	A	Pass
30	90	25	C	A	Pass
30	135	25	C	A	Pass
30	180	25	C	A	Pass
30	225	25	C	A	Pass
30	270	25	C	A	Pass
30	315	25	C	A	Pass
>95	0	0.5	B	A	Pass
>95	45	0.5	B	A	Pass
>95	90	0.5	B	A	Pass
>95	135	0.5	B	A	Pass
>95	180	0.5	B	A	Pass
>95	225	0.5	B	A	Pass
>95	270	0.5	B	A	Pass
>95	315	0.5	B	A	Pass
>95	0	250	C	C	Pass
>95	45	250	C	C	Pass
>95	90	250	C	C	Pass
>95	135	250	C	C	Pass
>95	180	250	C	C	Pass
>95	225	250	C	C	Pass
>95	270	250	C	C	Pass
>95	315	250	C	C	Pass

- Meet criteria A : Operate as intended during and after the test
- Meet criteria B : Operate as intended after the test
- Meet criteria C : Loss/Error of function
- Additional Information
 - The nominal voltage of EUT is 230V.
 - EUT stopped operation and could / could not be reset by operator at _____.
 - No false alarms or other malfunctions were observed during or after the test. The acceptance criteria were met, and the EUT passed the test.

14.7. Test Photograph

Test Mode : Mode 1: PC Printing (110W)

Description : Voltage Dips and Interruption Test Setup



Test Mode : Mode 2: LAN Printing (110W)

Description : Voltage Dips and Interruption Test Setup



Test Mode : Mode 3: Document Printing (110W)

Description : Voltage Dips and Interruption Test Setup



Test Mode : Mode 4: WiFi Printing (110W)

Description : Voltage Dips and Interruption Test Setup



Test Mode : Mode 5: PC Printing (72W)

Description : Voltage Dips and Interruption Test Setup



Test Mode : Mode 6: LAN Printing (72W)

Description : Voltage Dips and Interruption Test Setup



Test Mode : Mode 7: Document Printing (72W)

Description : Voltage Dips and Interruption Test Setup



Test Mode : Mode 8: WiFi Printing (72W)

Description : Voltage Dips and Interruption Test Setup



15. Attachment

➤ **EUT Photograph**

(1) EUT Photo



(2) EUT Photo

