



# Dell PowerEdge T330 Owner's Manual

Regulatory Model: E35S Series  
Regulatory Type: E35S001



# Notes, cautions, and warnings

-  **NOTE:** A NOTE indicates important information that helps you make better use of your computer.
-  **CAUTION:** A CAUTION indicates either potential damage to hardware or loss of data and tells you how to avoid the problem.
-  **WARNING:** A WARNING indicates a potential for property damage, personal injury, or death.

© 2016 Dell Inc. All rights reserved. This product is protected by U.S. and international copyright and intellectual property laws. Dell and the Dell logo are trademarks of Dell Inc. in the United States and/or other jurisdictions. All other marks and names mentioned herein may be trademarks of their respective companies.

2016 - 04

Rev. A01

# Contents

<b>1 About the Dell PowerEdge T330 system.....</b>	<b>9</b>
Supported configurations on Dell PowerEdge T330 system.....	9
Front panel features and indicators — tower mode.....	10
Front panel features and indicators — rack mode.....	15
LCD panel features.....	17
Home screen.....	18
Setup menu.....	18
View menu.....	19
Diagnostic indicators.....	19
Hot swappable hard drive indicator codes.....	21
Back panel features and indicators.....	22
NIC indicator codes.....	24
Redundant power supply unit indicator codes.....	24
Indicator codes for non-redundant power supply unit.....	26
Documentation matrix.....	27
Accessing system information by using QRL.....	28
<b>2 Performing initial system configuration .....</b>	<b>29</b>
Setting up your system.....	29
Setting up and configuring the iDRAC IP address .....	29
Logging in to iDRAC.....	30
Methods of installing the operating system.....	30
Managing your system remotely.....	30
Downloading drivers and firmware.....	30
<b>3 Pre-operating system management applications.....</b>	<b>32</b>
Navigation keys.....	32
System Setup.....	32
Entering System Setup.....	33
System Setup details.....	33
System BIOS Settings details.....	33
System Information details.....	34
Memory Settings details.....	34
Processor Settings details.....	35
SATA Settings details.....	36
Boot Settings details.....	38
Network Settings screen details.....	38
Integrated Devices details.....	39

Serial Communication details.....	40
System Profile Settings details.....	41
System Security Settings details.....	42
Miscellaneous Settings details.....	43
About Boot Manager.....	44
Viewing Boot Manager.....	44
Boot Manager main menu.....	44
About Dell Lifecycle Controller.....	45
Changing the boot order.....	45
Choosing the system boot mode.....	45
Creating a system or setup password.....	46
Using your system password to secure your system.....	46
Deleting or changing system and setup password.....	47
Operating with a setup password enabled.....	47
Embedded system management.....	47
iDRAC Settings utility.....	48
Entering the iDRAC Settings utility.....	48
Changing the thermal settings.....	48

## **4 Installing and removing system components.....49**

Safety instructions.....	49
Before working inside your system.....	49
After working inside your system.....	50
Recommended tools.....	50
Front bezel (optional).....	50
Installing the optional front bezel.....	50
Removing the optional front bezel.....	51
System feet.....	51
Removing the system feet.....	51
Installing the system feet.....	52
Caster wheels (optional)—tower mode.....	53
Installing caster wheels.....	53
Removing caster wheels.....	54
System cover.....	55
Removing the system cover.....	55
Installing the system cover.....	56
Inside the system.....	57
Optical drives and tape drives (optional).....	57
Removing the optional optical drive or tape drive.....	58
Installing the optical drive or tape drive.....	61
Cooling shroud.....	61
Removing the cooling shroud.....	61

Installing the cooling shroud.....	62
Intrusion switch.....	63
Removing the intrusion switch.....	63
Installing the intrusion switch.....	64
Hard drives.....	65
Supported hard drive configurations.....	65
Removing a 3.5-inch hot swappable hard drive carrier blank.....	66
Installing a 3.5-inch hot swappable hard drive carrier blank.....	66
Removing a hot swappable hard drive carrier.....	67
Removing a hot swappable hard drive from a hard drive carrier.....	68
Installing a hot swappable hard drive into a hot swappable hard drive carrier.....	69
Installing a hot swappable hard drive carrier.....	70
Installing a 2.5-inch hot swappable hard drive into a 3.5-inch hard drive adapter.....	71
Installing a 3.5-inch hard drive adapter into the 3.5-inch hot swappable hard drive carrier.....	72
Removing a 3.5-inch hard drive adapter from a 3.5-inch hot swappable hard drive carrier.....	73
Removing a 2.5-inch hot swappable hard drive from a 3.5-inch hard drive adapter.....	73
Hard drive backplane.....	73
Removing the hard drive backplane .....	74
Installing the hard drive backplane.....	78
Four-slot hard drive blank.....	78
Removing a four-slot hard drive blank.....	78
Installing a four-slot hard drive blank.....	79
System memory.....	80
General memory module installation guidelines.....	81
Sample memory configurations.....	82
Removing memory modules.....	83
Installing memory modules.....	84
Cooling fans.....	85
Removing the internal cooling fan.....	86
Installing the internal cooling fan.....	87
Internal USB memory key (optional).....	88
Replacing the optional internal USB memory key.....	88
Expansion cards.....	89
Expansion card installation guidelines.....	89
Removing an expansion card.....	90
Installing an expansion card.....	92
iDRAC port card (optional).....	93
Removing the optional iDRAC port card.....	93
Installing the optional iDRAC port card.....	95
Replacing an optional SD vFlash card.....	95
Internal dual SD module (optional).....	96
Removing an optional internal SD card.....	96

Installing an optional internal SD card.....	97
Removing the optional internal dual SD module .....	97
Installing the optional internal dual SD module .....	99
Heat sink and processor.....	99
Removing the heat sink.....	100
Removing the processor.....	101
Installing the processor.....	104
Installing the heat sink.....	106
Power supply units.....	108
Redundant AC power supply unit.....	108
Non-redundant AC power supply unit.....	113
Power interposer board.....	115
Removing the power interposer board.....	115
Installing the power interposer board.....	116
System battery.....	117
Replacing the system battery.....	117
Control panel assembly.....	119
Removing the control panel assembly.....	119
Installing the control panel assembly.....	121
Removing the control panel assembly cover.....	122
Installing the control panel assembly cover.....	123
Removing the control panel board.....	124
Installing the control panel board.....	125
Removing the LCD module.....	126
Installing the LCD module.....	127
Removing the optional VGA module.....	128
Installing the optional VGA module.....	129
System board.....	129
Removing the system board.....	129
Installing the system board.....	133
Restoring the Service Tag by using the Easy Restore feature.....	134
Entering the system Service Tag by using System Setup.....	134
Trusted Platform Module.....	135
Installing the Trusted Platform Module.....	135
Initializing the TPM for BitLocker users.....	136
Initializing the TPM for TXT users.....	136
System top cover.....	137
Removing the system top cover.....	137
Installing the system top cover.....	138
<b>5 Converting the system from tower mode to rack mode.....</b>	<b>139</b>
Safety instructions.....	139

Preparing a system for conversion from tower mode to rack mode.....	139
<b>6 Troubleshooting your system.....</b>	<b>142</b>
Safety first — for you and your system.....	142
Troubleshooting system startup failure.....	142
Troubleshooting external connections.....	142
Troubleshooting the video subsystem.....	142
Troubleshooting a USB device.....	143
Troubleshooting iDRAC Direct (USB XML configuration).....	143
Troubleshooting iDRAC Direct (Laptop connection).....	144
Troubleshooting a serial I/O device.....	144
Troubleshooting a NIC.....	144
Troubleshooting a wet system.....	145
Troubleshooting a damaged system.....	146
Troubleshooting the system battery.....	146
Troubleshooting power supply units.....	147
Troubleshooting power source problems.....	147
Power supply unit problems.....	147
Troubleshooting cooling problems.....	148
Troubleshooting cooling fans.....	148
Troubleshooting system memory.....	149
Troubleshooting an internal USB key.....	150
Troubleshooting an SD card.....	150
Troubleshooting an optical drive.....	151
Troubleshooting a tape backup unit.....	152
Troubleshooting a hard drive.....	152
Troubleshooting a storage controller.....	153
Troubleshooting expansion cards.....	154
Troubleshooting processors.....	154
<b>7 Using system diagnostics.....</b>	<b>156</b>
Dell Embedded System Diagnostics.....	156
When to use the Embedded System Diagnostics.....	156
Running the Embedded System Diagnostics from Boot Manager.....	156
Running the Embedded System Diagnostics from the Dell Lifecycle Controller.....	156
System diagnostics controls.....	157
<b>8 Jumpers and connectors.....</b>	<b>158</b>
System board jumpers and connectors.....	158
System board jumper settings.....	159
Disabling a forgotten password.....	160

<b>9 Technical specifications.....</b>	<b>161</b>
Dimensions and weight.....	161
Processor specifications.....	161
Expansion bus specifications.....	161
Memory specifications.....	161
Power specifications.....	162
Storage controller specifications.....	162
Drive specifications.....	163
Connectors specifications.....	163
Video specifications.....	164
Expanded operating temperature.....	164
Environmental specifications.....	165
<b>10 Getting help.....</b>	<b>167</b>
Contacting Dell.....	167
Locating Service Tag of your system.....	167
Accessing system information by using QRL.....	167



# About the Dell PowerEdge T330 system

The Dell PowerEdge T330 system is a rackable tower server that supports one processor based on the Intel E5-1200 v5 processor family, up to four DIMMs, and storage capacity of up to eight hard drives/solid state drives.

## Supported configurations on Dell PowerEdge T330 system

**Table 1. Supported configurations on Dell PowerEdge T330 system**

<b>PowerEdge T330 System</b>	<b>Configurations</b>
Four hard drive systems	Up to four 3.5-inch (2.5-inch with adapter) hot swappable hard drives with redundant or non-redundant power supply unit (PSU)
Eight hard drive systems	Up to eight 3.5-inch (2.5-inch with adapter) hot swappable hard drives with redundant or non-redundant PSU

## Front panel features and indicators — tower mode

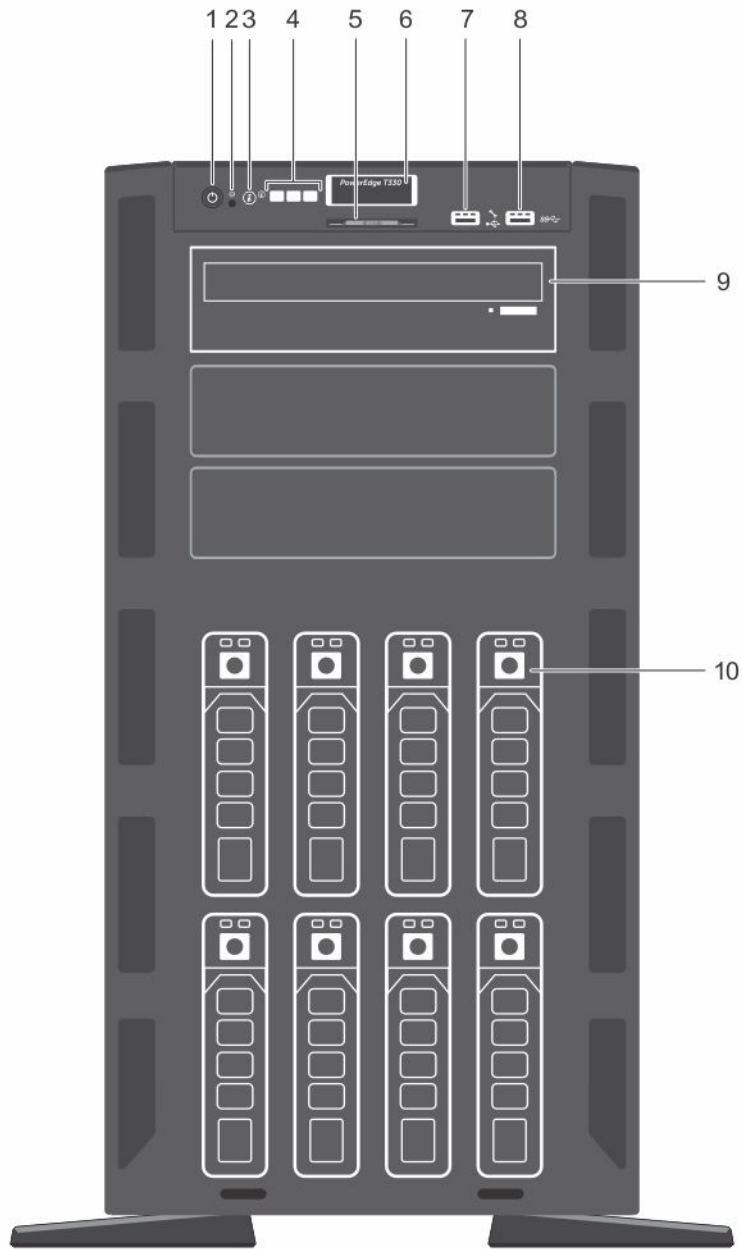





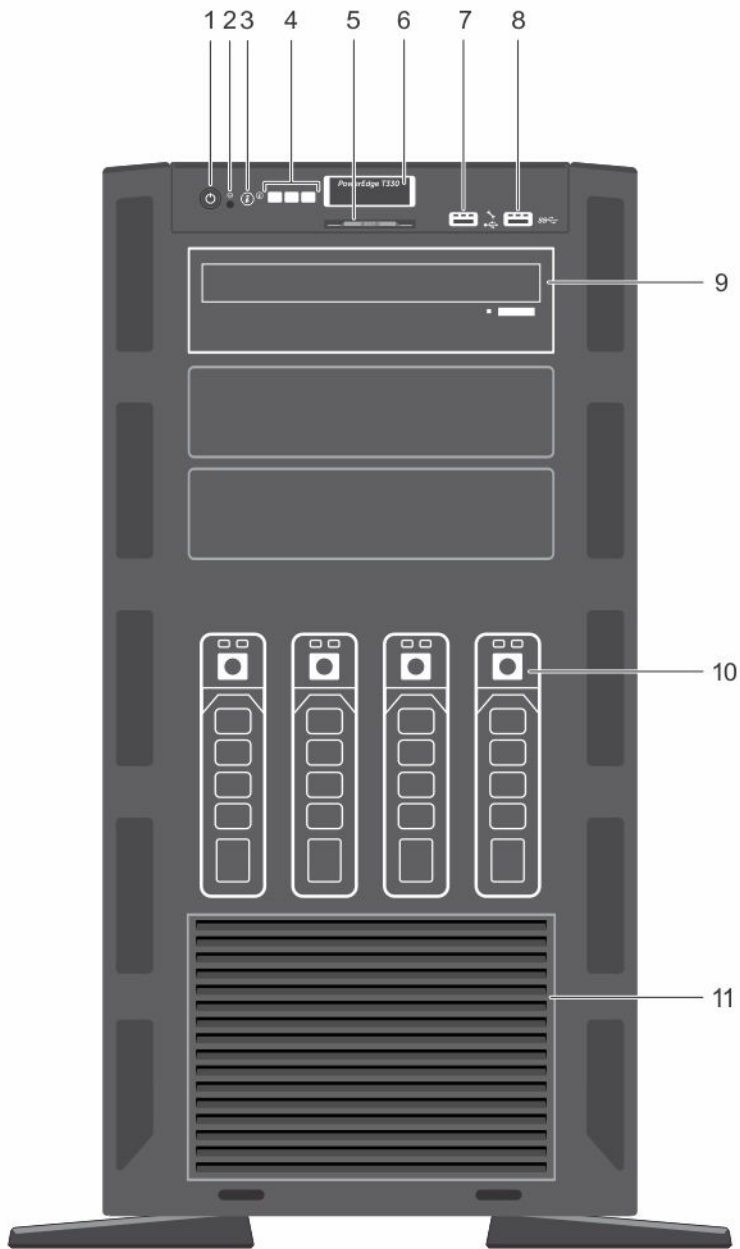

Figure 1. Front panel features and indicators — eight 3.5-inch hot swappable hard drive chassis

**Table 2. Front panel features and indicators — eight 3.5-inch hot swappable hard drive chassis**

Item	Indicator, button, or connector	Icon	Description
1	Power-on indicator, power button		<p>Enables you to know the power status of the system. The power-on indicator glows when the system power is on. The power button controls the power supply output to the system.</p> <p> <b>NOTE:</b> On ACPI-compliant operating systems, turning off the system using the power button causes the system to perform a graceful shutdown before power to the system is turned off.</p>
2	NMI button		<p>Enables you to troubleshoot software and device driver errors when running certain operating systems. This button can be pressed using the end of a paper clip.</p> <p>Use this button only if directed to do so by qualified support personnel or by the operating system documentation.</p>
3	System identification button		<p>Enables you to locate a particular system within a rack. The identification buttons are located on the front and back panels. When one of these buttons is pressed, the LCD panel on the front and the system status indicator on the back flash until one of the buttons is pressed again.</p> <p>Press the system identification button to turn the system ID on or off.</p> <p>If the system stops responding during POST, press and hold the system ID button for more than five seconds to enter BIOS progress mode.</p> <p>To reset iDRAC (if not disabled in F2 iDRAC setup) press and hold the system ID button for more than 15 seconds.</p>
4	LCD menu buttons		Enable you to navigate the control panel LCD menu.
5	Information tag		Contains system information such as service tag, NIC, MAC address, and so on for your reference. The information tag is a slide-out label panel.
6	LCD panel		Displays system ID, status information, and system error messages. See <a href="#">LCD panel features</a> .
7	USB management port/iDRAC Direct port		Functions as a regular USB port or provides access to the iDRAC Direct features. For more information, see the iDRAC Guide at <a href="http://Dell.com/idracmanuals">Dell.com/idracmanuals</a> .





Item	Indicator, button, or connector	Icon	Description
			This port is USB 2.0-compliant
8	USB connector		Enables you to connect USB devices to the system. This port is USB 3.0-compliant.
9	Optical drive or tape drives		Enables you to install an optical drive or tape drives. For more information about supported optical drives and tape drives, see <a href="#">Optical drives and tape drives (optional)</a> .
10	Hard drives		Enables you to install up to eight 3.5-inch (2.5-inch with adapter) hot swappable hard drives/SSDs.



**Figure 2. Front panel features and indicators — four 3.5-inch hot swappable hard drive chassis**

**Table 3. Front panel features and indicators — four 3.5-inch hot swappable hard drive chassis**

Item	Indicator, button, or connector	Icon	Description
1	Power-on indicator, power button		Enables you to know the power status of the system. The power-on indicator glows when the system power is on. The power button controls the power supply output to the system.

Item	Indicator, button, or connector	Icon	Description
			 <b>NOTE:</b> On ACPI-compliant operating systems, turning off the system using the power button causes the system to perform a graceful shutdown before power to the system is turned off.
2	NMI button		<p>Enables you to troubleshoot software and device driver errors when running certain operating systems. This button can be pressed using the end of a paper clip.</p> <p>Use this button only if directed to do so by qualified support personnel or by the operating system documentation.</p>
3	System identification button		<p>Enables you to locate a particular system within a rack. The identification buttons are located on the front and back panels. When one of these buttons is pressed, the LCD panel on the front and the system status indicator on the back flash until one of the buttons is pressed again.</p> <p>Press the system identification button to turn the system ID on or off.</p> <p>If the system stops responding during POST, press and hold the system ID button for more than five seconds to enter BIOS progress mode.</p> <p>To reset iDRAC (if not disabled in F2 iDRAC setup) press and hold the system ID button for more than 15 seconds.</p>
4	LCD menu buttons		Enables you to navigate the control panel LCD menu.
5	Information tag		Contains system information such as service tag, NIC, MAC address, and so on for your reference. The information tag is a slide-out label panel.
6	LCD panel		Displays system ID, status information, and system error messages. See <a href="#">LCD panel features</a> .
7	USB management port/ iDRAC Direct port		<p>Functions as a regular USB port or provides access to the iDRAC Direct features. For more information, see the iDRAC Guide at <b>Dell.com/idracmanuals</b>.</p> <p>This port is USB 2.0-compliant</p>
8	USB connector		Enables you to connect USB devices to the system. This port is USB 3.0-compliant.

Item	Indicator, button, or connector	Icon	Description
9	Optical drive or tape drives		Enables you to install an optical drive or tape drives. For more information about supported optical drives and tape drives, see <a href="#">Optical drives and tape drives (optional)</a> .
10	Hard drives		Enables you to install up to four 3.5-inch (2.5-inch with adapter) hot swappable hard drives/SSDs.
11	Four-slot hard drive blank		Supported on systems with an x8 hard drive backplane configured for software RAID support. These systems support only four hard drives, and the remaining hard drive slots are preinstalled with the four-slot hard drive blank, and cannot be upgraded for additional storage.

## Front panel features and indicators – rack mode

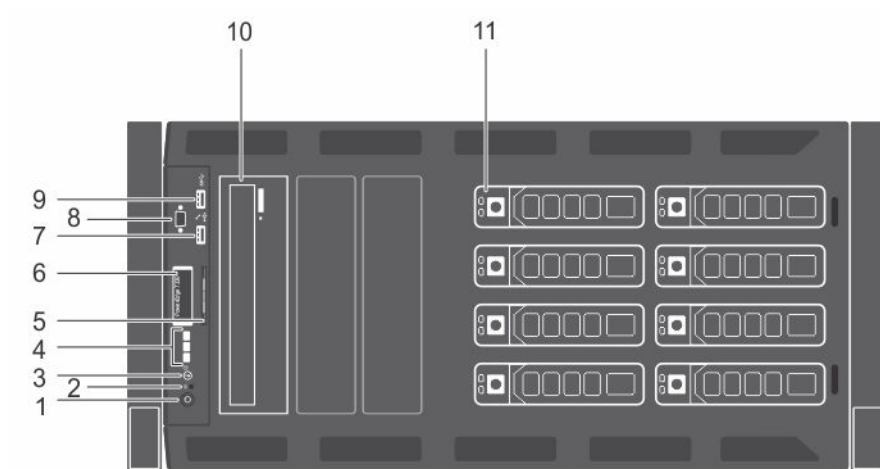









Figure 3. Front panel features and indicators – rack mode

Table 4. Front panel features and indicators – rack mode

Item	Indicator, button, or connector	Icon	Description
1	Power-on indicator, power button		Enables you to know the power status of the system. The power-on indicator glows when the system power is on. The power button controls the power supply output to the system.

Item	Indicator, button, or connector	Icon	Description
			 <b>NOTE:</b> On ACPI-compliant operating systems, turning off the system using the power button causes the system to perform a graceful shutdown before power to the system is turned off.
2	NMI button		<p>Enables you to troubleshoot software and device driver errors when running certain operating systems. This button can be pressed using the end of a paper clip.</p> <p>Use this button only if directed to do so by qualified support personnel or by the operating system documentation.</p>
3	System identification button		<p>Enables you to locate a particular system within a rack. The identification buttons are located on the front and back panels. When one of these buttons is pressed, the LCD panel on the front and the system status indicator on the back flash until one of the buttons is pressed again.</p> <p>Press the system identification button to turn the system ID on or off</p> <p>If the system stops responding during POST, press and hold the system ID button for more than five seconds to enter BIOS progress mode.</p> <p>To reset iDRAC (if not disabled in F2 iDRAC setup) press and hold the system ID button for more than 15 seconds.</p>
4	LCD menu buttons		Enable you to navigate the control panel LCD menu.
5	Information tag		Contains system information such as service tag, NIC, MAC address, and so on for your reference. The information tag is a slide-out label panel.
6	LCD panel		Displays system ID, status information, and system error messages. See <a href="#">LCD panel features</a> .
7	USB management port/ iDRAC Direct port		<p>Functions as a regular USB port or provides access to the iDRAC Direct features. For more information, see the iDRAC Guide at <a href="http://Dell.com/idracmanuals">Dell.com/idracmanuals</a>.</p> <p>This port is USB 2.0-compliant</p>
8	Video connector		Enables you to connect a display to the system.



Item	Indicator, button, or connector	Icon	Description
			 <b>NOTE:</b> The video connector is available only in the rack-mode configuration of your system. For information on converting your system from tower to the rack mode, see <a href="#">Preparing a system for conversion from tower mode to rack mode</a> .
9	USB connector		Enables you to connect USB devices to the system. This port is USB 3.0-compliant.
10	Optical drive or tape drives		Enables you to install an optical drive or tape drives. For more information about supported optical drives and tape drives, see <a href="#">Optical drives and tape drives (optional)</a> .
11	Hard drives		Enables you to install up to eight 3.5-inch (2.5 inch with adapter) hot swappable hard drives or four 3.5-inch (2.5 inch with adapter) hot swappable hard drives.

## LCD panel features

The system's LCD panel provides system information and status and error messages to indicate if the system is operating correctly or if the system needs attention. For more information about the error messages, see the *Dell Event and Error Messages Reference Guide* at [Dell.com/openmanagemanuals](http://Dell.com/openmanagemanuals) > **OpenManage software**.

- The LCD backlight turns blue during normal operating conditions and turns amber to indicate an error condition.
- The LCD backlight is turned off when the system is in standby mode and can be turned on by pressing either the Select, Left, or Right button on the LCD panel.
- The LCD backlight remains OFF if LCD messaging is turned off through the iDRAC utility, the LCD panel, or other tools.

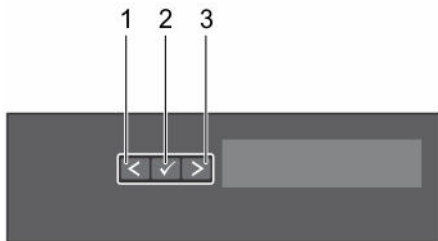

**Figure 4. LCD panel Features**



1. Left
2. Select
3. Right

Button	Description
Left	Moves the cursor back in one-step increments.
Select	Selects the menu item highlighted by the cursor.
Right	Moves the cursor forward in one-step increments. During message scrolling: <ul style="list-style-type: none"> <li>• Press once to increase scrolling speed</li> <li>• Press again to stop</li> <li>• Press again to return to the default scrolling speed</li> <li>• Press again to repeat the cycle</li> </ul>

## Home screen

The Home screen displays user-configurable information about the system. This screen is displayed during normal system operation when there are no status messages or errors. When the system is in standby mode, the LCD backlight turns off after five minutes of inactivity if there are no error messages. Press one of the three navigation buttons (Select, Left, or Right) to view the Home screen.

To navigate to the **Home** screen from another menu, complete the following steps:

1. Press and hold the up arrow  until the **Home** icon  is displayed.
2. Select the **Home** icon.
3. On the **Home** screen, press the **Select** button to enter the main menu.

## Setup menu

 **NOTE:** When you select an option in the Setup menu, you must confirm the option before proceeding to the next action.

Option	Description
iDRAC	Select <b>DHCP</b> or <b>Static IP</b> to configure the network mode. If <b>Static IP</b> is selected, the available fields are <b>IP</b> , <b>Subnet (Sub)</b> , and <b>Gateway (Gtw)</b> . Select <b>Setup DNS</b> to enable DNS and to view domain addresses. Two separate DNS entries are available.
Set error	Select <b>SEL</b> to view LCD error messages in a format that matches the IPMI description in the SEL. This enables you to match an LCD message with an SEL entry.  Select <b>Simple</b> to view LCD error messages in a simplified user-friendly description. For more information about error messages, see the <i>Dell Event and Error Messages Reference Guide</i> at <a href="http://Dell.com/openmanagemanuals">Dell.com/openmanagemanuals</a> > <b>OpenManage software</b> .
Set home	Select the default information to be displayed on the <b>Home</b> screen. See View menu section for the options and option items that can be set as the default on the <b>Home</b> screen.

## View menu

 **NOTE:** When you select an option in the View menu, you must confirm the option before proceeding to the next action.

Option	Description
iDRAC IP	Displays the <b>IPv4</b> or <b>IPv6</b> addresses for iDRAC8. Addresses include <b>DNS (Primary and Secondary)</b> , <b>Gateway, IP</b> , and <b>Subnet</b> (IPv6 does not have Subnet).
MAC	Displays the MAC addresses for <b>iDRAC</b> , <b>iSCSI</b> , or <b>Network</b> devices.
Name	Displays the name of the <b>Host</b> , <b>Model</b> , or <b>User String</b> for the system.
Number	Displays the <b>Asset tag</b> or the <b>Service tag</b> for the system.
Power	Displays the power output of the system in BTU/hr or Watts. The display format can be configured in the <b>Set home</b> submenu of the <b>Setup</b> menu.
Temperature	Displays the temperature of the system in Celsius or Fahrenheit. The display format can be configured in the <b>Set home</b> submenu of the <b>Setup</b> menu.



## Diagnostic indicators





The diagnostic indicators on the system front panel display system status during system startup.

 **NOTE:** The diagnostic indicators are not present if the system is equipped with an LCD display.

 **NOTE:** No diagnostic indicators are lit when the system is turned off. To start the system, plug it into a working power source and press the power button.

**Table 5. Diagnostic indicators**

Icon	Description	Condition	Corrective action
	Health indicator	<p>The indicator turns solid blue if the system is in good health.</p> <p>The indicator flashes amber:</p> <ul style="list-style-type: none"> <li>• When the system is turned on.</li> <li>• When the system is in standby.</li> <li>• If any error condition exists. For example, a failed fan, PSU, or a hard drive.</li> </ul>	<p>None required.</p> <p>Check the System Event Log or system messages for the specific issue. For more information about error messages, see the <i>Dell Event and Error Messages Reference Guide</i> at <a href="http://Dell.com/openmanagemanuals">Dell.com/openmanagemanuals</a> &gt; <b>OpenManage software</b>.</p> <p>The POST process is interrupted without any video output due to invalid memory configurations. See the Getting help section.</p>
	Hard drive indicator	The indicator flashes amber if there is a hard drive error.	Check the System Event Log to determine the hard drive that has an error. Run the appropriate Online Diagnostics test. Restart the system and run embedded diagnostics (ePSA). If the hard drives are configured in a

Icon	Description	Condition	Corrective action
			RAID array, restart the system and enter the host adapter configuration utility program.
	Electrical indicator	The indicator flashes amber if the system experiences an electrical error (for example, voltage out of range, or a failed power supply unit (PSU) or voltage regulator).	Check the System Event Log or system messages for the specific issue. If it is due to a problem with the PSU, check the LED on the PSU. Reseat the PSU. If the problem persists, see the Getting help section.
	Temperature indicator	The indicator flashes amber if the system experiences a thermal error (for example, the ambient temperature is out of range or fan failure).	Ensure that none of the following conditions exist: <ul style="list-style-type: none"> <li>• A cooling fan has been removed or has failed.</li> <li>• System cover, cooling shroud, EMI filler panel, memory module blank, or back filler bracket is removed.</li> <li>• Ambient temperature is too high.</li> <li>• External airflow is obstructed.</li> </ul> See the Getting help section.
	Memory indicator	The indicator flashes amber if a memory error occurs.	Check the system event log or system messages for the location of the failed memory. Reseat the memory module. If the problem persists, see the Getting help section.
	PCIe indicator	The indicator flashes amber if a PCIe card experiences an error.	Restart the system. Update any required drivers for the PCIe card. Reinstall the card. If the problem persists, see the Getting help section.

## Hot swappable hard drive indicator codes

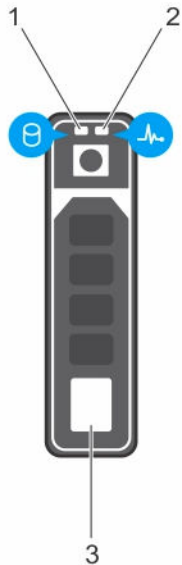

**Figure 5. Hot swappable hard drive indicators**

1. hard drive activity indicator
2. hard drive status indicator
3. hard drive

**NOTE:** If the hard drive is in Advanced Host Controller Interface (AHCI) mode, the status indicator (on the right side) does not function and remains OFF.

**Table 6. Hot swappable hard drive indicators**

Drive-status indicator pattern (RAID only)	Condition
Flashes green two times per second	Identifying drive or preparing for removal.
OFF	Drive ready for insertion or removal.
	<b>NOTE:</b> The drive status indicator remains OFF until all hard drives are initialized after the system is turned on. Drives are not ready for insertion or removal during this time.
Flashes green, amber, and turns off	Predicted drive failure
Flashes amber four times per second	Drive failed
Flashes green slowly	Drive rebuilding
Turns green	Drive online
Flashes green three seconds, amber three seconds, and turns off six seconds	Rebuild stopped

## Back panel features and indicators

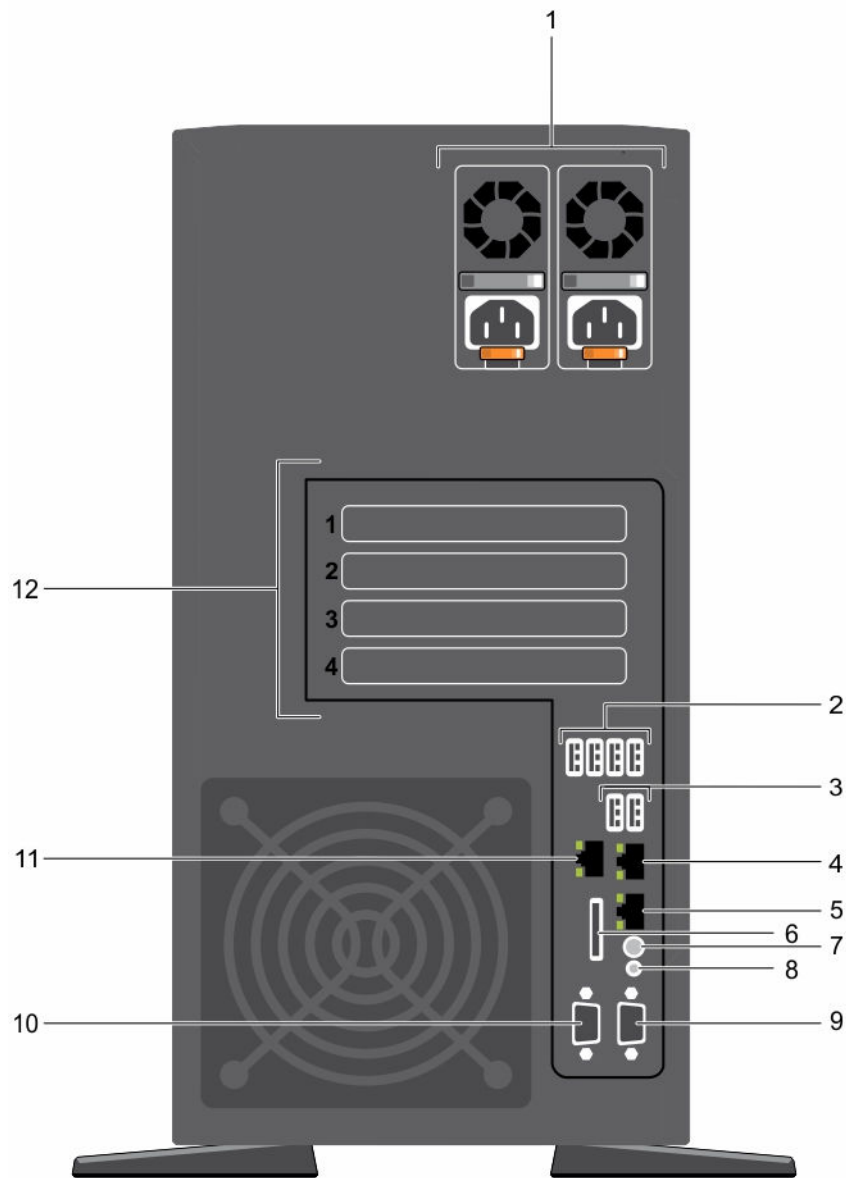









Figure 6. Back panel features and indicators

Table 7. Back panel features and indicators

Item	Indicator, button, or connector	Icon	Description
1	Power supply units (PSU1 and PSU2)		Enables you to install up to two 495 W redundant and 350 W non-redundant AC power supply units.

Item	Indicator, button, or connector	Icon	Description
			 <b>NOTE:</b> Non-redundant PSU is supported in systems with an x8 backplane.
2, 3	USB connectors (6)		Enables you to connect USB devices to the system. Four ports are USB 2.0-compliant and two ports are USB 3.0-compliant.
4, 5	Ethernet connectors (2)		Enable you to connect two integrated 10/100/1000 Mbps NIC connectors.
6	vFlash media card slot (optional)		Enables you to connect a vFlash media card.
7	System identification button		<p>Enables you to locate a particular system within a rack. The identification buttons are located on the front and back panels. When one of these buttons is pressed, the LCD panel on the front and the system status indicator on the back flash until one of the buttons is pressed again.</p> <p>Press the system identification button to turn the system ID on or off.</p> <p>If the system stops responding during POST, press and hold the system ID button for more than five seconds to enter the BIOS progress mode.</p> <p>To reset iDRAC (if not disabled in F2 iDRAC setup), press and hold for more than 15 seconds.</p>
8	System identification connector		Enables you to connect the optional system status indicator assembly through the optional cable management arm.
9	Video connector		Enables you to connect a VGA display to the system.
10	Serial connector		Enables you to connect a serial device to the system.
11	iDRAC port (optional)		Enables you to install a dedicated management port card.
12	PCIe expansion card slots (4)		Enables you to connect up to four full-height PCI expansion cards.







**Figure 8. AC PSU status indicator**

1. AC PSU status indicator/handle

**Table 9. AC PSU status indicator**

Convention	Power Indicator Pattern	Description
A	Green	A valid power source is connected to the PSU and the PSU is operational.
B	Flashing green	When the firmware of the PSU is being updated, the PSU handle flashes green.  <b>⚠ CAUTION: Do not disconnect the power cord or unplug the PSU when updating firmware. If firmware update is interrupted, the PSUs will not function. You must roll back the PSU firmware by using Dell Lifecycle Controller. See <i>Dell Lifecycle Controller User's Guide</i> at <a href="http://Dell.com/idracmanuals">Dell.com/idracmanuals</a>.</b>
C	Flashes green and turns off	When hot-adding a PSU, the PSU handle flashes green five times at 4 Hz rate and turns off. This indicates that there is a PSU mismatch with respect to efficiency, feature set, health status, and supported voltage. Replace the mismatch PSU with a PSU of matching capacity.  <b>⚠ CAUTION: For AC PSUs, use only PSUs with the Extended Power Performance (EPP) label on the back. Mixing PSUs from previous generations of PowerEdge servers can result in a PSU mismatch condition or failure to power on.</b>
D	Flashing amber	Indicates a problem with the PSU.

Convention	Power Indicator Pattern	Description
		<p>⚠ CAUTION: When correcting a PSU mismatch, replace only the PSU with the flashing indicator. Swapping the other PSU to make a matched pair can result in an error condition and unexpected system shutdown. To change from a High Output configuration to a Low Output configuration or vice versa, you must power down the system.</p> <p>⚠ CAUTION: AC PSUs support both 220 V and 110 V input voltages with the exception of Titanium PSUs, which support only 220 V. When two identical PSUs receive different input voltages, they can output different wattages, and trigger a mismatch.</p> <p>⚠ CAUTION: If two PSUs are used, they must be of the same type and have the same maximum output power.</p> <p>⚠ CAUTION: Combining AC and DC PSUs is not supported and triggers a mismatch.</p>
E	Not lit	Power is not connected.

## Indicator codes for non-redundant power supply unit

Press the self-diagnostic button to perform a quick health check on the non-redundant power supply unit (PSU) of the system.

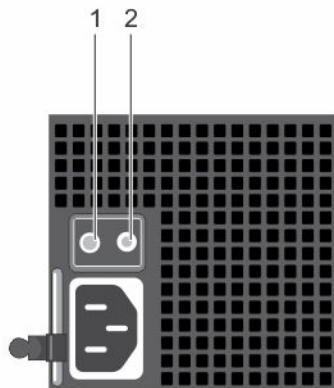

Figure 9. Non-redundant AC PSU status indicator and self-diagnostic button

1. self-diagnostic button
2. AC PSU status indicator

Table 10. Indicator codes for non-redundant power supply unit

Diagnostic Indicator Pattern	Description
Not lit	Power is not connected or PSU is faulty.
Green	A valid power source is connected to the PSU and the PSU is operational.

# Documentation matrix

The documentation matrix provides information on documents that you can refer to for setting up and managing your system.

**Table 11. Documentation matrix**

To...	See the...
Install your system into a rack	Rack documentation included with your rack solution
Set up your system and know the system technical specifications	<i>Getting Started With Your System</i> that shipped with your system or see <b>Dell.com/poweredgemanuals</b>
Install the operating system	Operating system documentation at <b>Dell.com/operatingsystemmanuals</b>
Get an overview of the Dell Systems Management offerings	<i>Dell OpenManage Systems Management Overview Guide</i> at <b>Dell.com/openmanagemanuals &gt; OpenManage software</b>
Configure and log in to iDRAC, set up managed and management system, know the iDRAC features, and troubleshoot by using iDRAC	<i>Integrated Dell Remote Access Controller User's Guide</i> at <b>Dell.com/idracmanuals</b>
Know about the RACADM subcommands and supported RACADM interfaces	<i>RACADM Command Line Reference Guide</i> for iDRAC at <b>Dell.com/idracmanuals</b>
Launch, enable, and disable Dell Lifecycle Controller, know the features, use and troubleshoot Dell Lifecycle Controller	<i>Dell Lifecycle Controller User's Guide</i> at <b>Dell.com/idracmanuals</b>
Use Dell Lifecycle Controller Remote Services	<i>Dell Lifecycle Controller Remote Services Quick Start Guide</i> at <b>Dell.com/idracmanuals</b>
Set up, use, and troubleshoot OpenManage Server Administrator	<i>Dell OpenManage Server Administrator User's Guide</i> at <b>Dell.com/openmanagemanuals &gt; OpenManage Server Administrator</b>
Install, use, and troubleshoot OpenManage Essentials	<i>Dell OpenManage Essentials User's Guide</i> at <b>Dell.com/openmanagemanuals &gt; OpenManage Essentials</b>
Know the features of the storage controller cards, deploy the cards, and manage the storage subsystem	Storage controller documentation at <b>Dell.com/storagecontrollermanuals</b>
Check the event and error messages generated by the system firmware and agents that monitor system components	<i>Dell Event and Error Messages Reference Guide</i> at <b>Dell.com/openmanagemanuals &gt; OpenManage software</b>

## Accessing system information by using QRL

You can use the Quick Resource Locator (QRL) to get immediate access to the information about your system.

### Prerequisites

Ensure that your smartphone or tablet has the QR code scanner installed.

### About this task

The QRL includes the following information about your system:

- How-to videos
- Reference materials, including the Owner's Manual, LCD diagnostics, and mechanical overview
- Your system service tag to quickly access your specific hardware configuration and warranty information
- A direct link to Dell to contact technical support and sales teams

### Steps

1. Go to **Dell.com/QRL** and navigate to your specific product or
2. Use your smartphone or tablet to scan the model-specific Quick Resource (QR) code located in the following image or on your Dell PowerEdge system:



# Performing initial system configuration

After you receive your system, you must set up your system, install the operating system if it is not pre-installed, and set up and configure the system iDRAC IP address.

## Setting up your system

1. Unpack the server.
2. Install the server into the rack. For more information about installing the server into the rack, see your system *Rack Installation Placemat* at [Dell.com/poweredgedmanuals](https://Dell.com/poweredgedmanuals). For tower systems that can be converted to the rack mode, see [Preparing a system for conversion from tower mode to rack mode](#).
3. Connect the peripherals to the system.
4. Connect the system to its electrical outlet.
5. Turn on the system by pressing the power button or using iDRAC.
6. Turn on the attached peripherals.

## Setting up and configuring the iDRAC IP address

You can set up the Integrated Dell Remote Access Controller (iDRAC) IP address by using one of the following interfaces:

- iDRAC Settings utility
- Dell Lifecycle Controller
- Dell OpenManage Deployment Toolkit
- Server LCD panel

You can use the default iDRAC IP address 192.168.0.120 to configure the initial network settings, including setting up DHCP or a static IP for iDRAC.

 **NOTE:** To access iDRAC, ensure that you install the iDRAC port card or connect the network cable to the Ethernet connector 1 on the system board.

You can configure iDRAC IP address by using the following interfaces:

 **NOTE:** Make sure that you change the default user name and password after setting up the iDRAC IP address.

- iDRAC web interface — For more information, see the Integrated Dell Remote Access Controller User's Guide.
- Remote Access Controller Admin (RACADM) — For more information, see the RACADM Command Line Interface Reference Guide and the Integrated Dell Remote Access Controller User's Guide.
- Remote Services that include Web Services Management (WS-Man) — For more information, see the Dell Lifecycle Controller Remote Services Quick Start Guide.

For more information about setting up and configuring iDRAC, see the Integrated Dell Remote Access Controller User's Guide at [Dell.com/idracmanuals](https://www.dell.com/support/manuals/iDRAC).

## Logging in to iDRAC

You can log in to iDRAC as an iDRAC local user, a Microsoft Active Directory user, or a Lightweight Directory Access Protocol (LDAP) user. You can also log in by using Single Sign-On or a Smart Card. The default user name is `root` and password is `calvin`. For more information about logging in to iDRAC and iDRAC licenses, see the *Integrated Dell Remote Access Controller User's Guide* available at [Dell.com/idracmanuals](https://www.dell.com/support/manuals/iDRAC).

You can also access iDRAC by using RACADM. For more information, see the *RACADM Command Line Interface Reference Guide* and the *Integrated Dell Remote Access Controller User's Guide* available at [Dell.com/idracmanuals](https://www.dell.com/support/manuals/iDRAC).

## Methods of installing the operating system

If the system is shipped without an operating system, install the supported OS on the system by using one of the following methods:

- Dell Systems Management Tools and Documentation media — see the operating system documentation available at [Dell.com/operatingsystemmanuals](https://www.dell.com/support/manuals/STMT).
- Dell Lifecycle Controller — see the Dell Lifecycle Controller documentation available at [Dell.com/idracmanuals](https://www.dell.com/support/manuals/DLC).
- Dell OpenManage Deployment Toolkit — see the Dell OpenManage documentation available at [Dell.com/openmanagemanuals](https://www.dell.com/support/manuals/DM) → **OpenManage software**.

For information about supported operating systems, see the operating systems support matrix available at [Dell.com/ossupport](https://www.dell.com/support/ossupport).

## Managing your system remotely

To perform out-of-band systems management by using iDRAC, you must configure iDRAC for remote accessibility, set up the management station and managed system, and configure the supported web browsers. For more information, see the *Integrated Dell Remote Access Controller User's Guide* at [Dell.com/idracmanuals](https://www.dell.com/support/manuals/iDRAC).

You can also remotely monitor and manage the server, using the Dell OpenManage Server Administrator (OMSA) software and OpenManage Essentials (OME) systems management console. For more information, see [Dell.com/openmanagemanuals](https://www.dell.com/support/manuals/OMSA).

## Downloading drivers and firmware

Dell recommends that you download and install the latest BIOS, drivers, and systems management firmware on your system.

### Prerequisites

Ensure that you clear the web browser cache.

## Steps

1. Go to **Dell.com/support/drivers**.
2. In the **Product Selection** section, enter the Service Tag of your system in the **Service Tag or Express Service Code** field.  
 **NOTE:** If you do not have the Service Tag, select **Automatically detect my Service Tag** to enable the system to automatically detect the service tag, or select your product from the **Product Selection** page.
3. Click **Get drivers and downloads**.  
The drivers that are applicable to your selection are displayed.
4. Download the drivers that you need to a USB drive, CD, or DVD.

# Pre-operating system management applications

You can manage basic settings and features of a system without booting to the operating system by using the system firmware.

## Navigation keys

The navigation keys can help you quickly access the pre-operating system management applications.

Key	Description
F2	Enables you to enter <b>System Setup</b> .
F10	Enables you to enter system services and starts <b>Lifecycle Controller</b> .
F11	Enables you to enter <b>Boot Manager</b> .
F12	Enables you to enter <b>PXE Boot</b> .
Page Up	Enables you to move to the previous screen.
Page Down	Enables you to move to the next screen.
Up arrow	Enables you to move to the previous field.
Down arrow	Enables you to move to the next field.
Enter	Enables you to type a value in the selected field (if applicable).
Spacebar	Enables you to expand or collapse a drop-down list, if applicable.
Tab	Enables you to move to the next menu item.
	 <b>NOTE:</b> This feature is applicable only for the standard graphic browser.
Esc	Enables you to move to the previous page until you view the main screen. Pressing Esc in the main screen exits <b>System BIOS, iDRAC Settings, Device Settings, or Service Tag Settings</b> , and proceeds with system boot.
F1	Displays the system setup help.

## System Setup

By using the **System Setup** screen, you can configure the BIOS settings, iDRAC settings, and device settings of your system.

 **NOTE:** Help text for the selected field is displayed in the graphical browser by default. To view the help text in the text browser, press F1.



You can access system setup by using two methods:

- Standard graphical browser—The browser is enabled by default.
- Text browser—The browser is enabled by using Console Redirection.

## Entering System Setup

1. Turn on, or restart your system.
2. Press F2 immediately after you see the following message:  
F2 = System Setup

If your operating system begins to load before you press F2, wait for the system to finish booting, and then restart your system and try again.

## System Setup details

The **System Setup Main Menu** screen details are explained as follows:

Option	Description
<b>System BIOS</b>	Enables you to configure BIOS settings.
<b>iDRAC Settings</b>	Enables you to configure iDRAC settings. The iDRAC settings utility is an interface to set up and configure the iDRAC parameters by using UEFI (Unified Extensible Firmware Interface). You can enable or disable various iDRAC parameters by using the iDRAC settings utility. For more information about this utility, see <i>Integrated Dell Remote Access Controller User's Guide</i> at <a href="http://Dell.com/idracmanuals">Dell.com/idracmanuals</a> .
<b>Device Settings</b>	Enables you to configure device settings.

## System BIOS Settings details

The **System BIOS Settings** screen details are explained as follows:

Option	Description
<b>System Information</b>	Specifies information about the system such as the system model name, BIOS version, and Service Tag.
<b>Memory Settings</b>	Specifies information and options related to the installed memory.
<b>Processor Settings</b>	Specifies information and options related to the processor such as speed and cache size.
<b>SATA Settings</b>	Specifies options to enable or disable the integrated SATA controller and ports.
<b>Boot Settings</b>	Specifies options to specify the boot mode (BIOS or UEFI). Enables you to modify UEFI and BIOS boot settings.
<b>Network Settings</b>	Specifies options to change the network settings.
<b>Integrated Devices</b>	Specifies options to manage integrated device controllers and ports and specify related features and options.

Option	Description
<b>Serial Communication</b>	Specifies options to manage the serial ports and specify related features and options.
<b>System Profile Settings</b>	Specifies options to change the processor power management settings, memory frequency, and so on.
<b>System Security</b>	Specifies options to configure the system security settings, such as system password, setup password, Trusted Platform Module (TPM) security. It also manages the power and NMI buttons on the system.
<b>Miscellaneous Settings</b>	Specifies options to change the system date, time, and so on.

## System Information details

The **System Information** screen details are explained as follows:

Option	Description
<b>System Model Name</b>	Specifies the system model name.
<b>System BIOS Version</b>	Specifies the BIOS version installed on the system.
<b>System Management Engine Version</b>	Specifies the current version of the Management Engine firmware.
<b>System Service Tag</b>	Specifies the system Service Tag.
<b>System Manufacturer</b>	Specifies the name of the system manufacturer.
<b>System Manufacturer Contact Information</b>	Specifies the contact information of the system manufacturer.
<b>System CPLD Version</b>	Specifies the current version of the system complex programmable logic device (CPLD) firmware.
<b>UEFI Compliance Version</b>	Specifies the UEFI compliance level of the system firmware.

## Memory Settings details



The **Memory Settings** screen details are explained as follows:

Option	Description
<b>System Memory Size</b>	Specifies the memory size in the system.
<b>System Memory Type</b>	Specifies the type of memory installed in the system.

Option	Description
<b>System Memory Speed</b>	Specifies the system memory speed.
<b>System Memory Voltage</b>	Specifies the system memory voltage.
<b>Video Memory</b>	Specifies the amount of video memory.
<b>System Memory Testing</b>	Specifies whether the system memory tests are run during system boot. Options are <b>Enabled</b> and <b>Disabled</b> . This option is set to <b>Disabled</b> by default.
<b>Memory Operating Mode</b>	Specifies the memory operating mode. The available option is <b>Optimizer Mode</b> .

## Processor Settings details

The **Processor Settings** screen details are explained as follows:

Option	Description
<b>Logical Processor</b>	Enables or disables the logical processors and displays the number of logical processors. If this option is set to <b>Enabled</b> , the BIOS displays all the logical processors. If this option is set to <b>Disabled</b> , the BIOS displays only one logical processor per core. This option is set to <b>Enabled</b> by default.
<b>QPI Speed</b>	Enables you to control QuickPath Interconnect data rate settings.
<b>Virtualization Technology</b>	Enables or disables the additional hardware capabilities provided for virtualization. This option is set to <b>Enabled</b> by default.
<b>Adjacent Cache Line Prefetch</b>	Optimizes the system for applications that need high utilization of sequential memory access. This option is set to <b>Enabled</b> by default. You can disable this option for applications that need high utilization of random memory access.
<b>Hardware Prefetcher</b>	Enables or disables the hardware prefetcher. This option is set to <b>Enabled</b> by default.
<b>DCU Streamer Prefetcher</b>	Enables or disables the Data Cache Unit (DCU) streamer prefetcher. This option is set to <b>Enabled</b> by default.
<b>DCU IP Prefetcher</b>	Enables or disables the Data Cache Unit (DCU) IP prefetcher. This option is set to <b>Enabled</b> by default.
<b>Configurable TDP</b>	Enables you to reconfigure the processor Thermal Design Power (TDP) levels during POST based on the power and thermal delivery capabilities of the system. TDP verifies the maximum heat the cooling system is needed to dissipate. This option is set to <b>Nominal</b> by default.   <b>NOTE:</b> This option is only available on certain stock keeping units (SKUs) of the processors.
<b>X2Apic Mode</b>	Enables or disables the X2Apic mode.
<b>Dell Controlled Turbo</b>	Controls the turbo engagement. Enable this option only when <b>System Profile</b> is set to <b>Performance</b> .   <b>NOTE:</b> Depending on the number of installed CPUs, there may be up to four processor listings.

Option	Description
<b>Number of Cores per Processor</b>	Controls the number of enabled cores in each processor. This option is set to <b>All</b> by default.
<b>Processor 64-bit Support</b>	Specifies if the processor(s) support 64-bit extensions.
<b>Processor Core Speed</b>	Specifies the maximum core frequency of the processor.
<b>Processor 1</b>	The following settings are displayed for each processor installed in the system:

Option	Description
<b>Family-Model-Stepping</b>	Specifies the family, model, and stepping of the processor as defined by Intel.
<b>Brand</b>	Specifies the brand name.
<b>Level 2 Cache</b>	Specifies the total L2 cache.
<b>Level 3 Cache</b>	Specifies the total L3 cache.
<b>Number of Cores</b>	Specifies the number of cores per processor.

## SATA Settings details

The **SATA Settings** screen details are explained as follows:

Option	Description
<b>Embedded SATA</b>	Enables the embedded SATA option to be set to <b>Off</b> , <b>AHCI</b> , or <b>RAID</b> modes. This option is set to <b>AHCI</b> by default.
<b>Security Freeze Lock</b>	Sends Security Freeze Lock command to the Embedded SATA drives during POST. This option is applicable only for AHCI mode.
<b>Write Cache</b>	Enables or disables the command for Embedded SATA drives during POST.
<b>Port A</b>	For <b>AHCI</b> or <b>RAID</b> mode, BIOS support is always enabled.

Option	Description
<b>Model</b>	Specifies the drive model of the selected device.
<b>Drive Type</b>	Specifies the type of drive attached to the SATA port.
<b>Capacity</b>	Specifies the total capacity of the hard drive. This field is undefined for removable media devices such as optical drives.

**Port B** For **AHCI** or **RAID** mode, BIOS support is always enabled.

Option	Description
<b>Model</b>	Specifies the drive model of the selected device.
<b>Drive Type</b>	Specifies the type of drive attached to the SATA port.

Option	Description
<b>Option</b>	<b>Description</b>
<b>Capacity</b>	Specifies the total capacity of the hard drive. This field is undefined for removable media devices such as optical drives.

**Port C** For **AHCI** or **RAID** mode, BIOS support is always enabled.

Option	Description
<b>Model</b>	Specifies the drive model of the selected device.
<b>Drive Type</b>	Specifies the type of drive attached to the SATA port.
<b>Capacity</b>	Specifies the total capacity of the hard drive. This field is undefined for removable media devices such as optical drives.

**Port D** For **AHCI** or **RAID** mode, BIOS support is always enabled.

Option	Description
<b>Model</b>	Specifies the drive model of the selected device.
<b>Drive Type</b>	Specifies the type of drive attached to the SATA port.
<b>Capacity</b>	Specifies the total capacity of the hard drive. This field is undefined for removable media devices such as optical drives.

**Port E** For **AHCI** or **RAID** mode, BIOS support is always enabled.





Option	Description
<b>Model</b>	Specifies the drive model of the selected device.
<b>Drive Type</b>	Specifies the type of drive attached to the SATA port.
<b>Capacity</b>	Specifies the total capacity of the hard drive. This field is undefined for removable media devices such as optical drives.

**Port F** For **AHCI** or **RAID** mode, BIOS support is always enabled.

Option	Description
<b>Model</b>	Specifies the drive model of the selected device.
<b>Drive Type</b>	Specifies the type of drive attached to the SATA port.
<b>Capacity</b>	Specifies the total capacity of the hard drive. This field is undefined for removable media devices such as optical drives.

## Boot Settings details

The **Boot Settings** screen details are explained as follows:

Option	Description
<b>Boot Mode</b>	<p>Enables you to set the boot mode of the system.</p> <p> <b>CAUTION: Switching the boot mode may prevent the system from booting if the operating system is not installed in the same boot mode.</b></p> <p>If the operating system supports UEFI, you can set this option to <b>UEFI</b>. Setting this field to <b>BIOS</b> allows compatibility with non-UEFI operating systems. This option is set to <b>BIOS</b> by default.</p> <p> <b>NOTE:</b> Setting this field to <b>UEFI</b> disables the <b>BIOS Boot Settings</b> menu. Setting this field to <b>BIOS</b> disables the <b>UEFI Boot Settings</b> menu.</p>
<b>Boot Sequence Retry</b>	<p>Enables or disables the Boot Sequence Retry feature. If this option is set to <b>Enabled</b> and the system fails to boot, the system reattempts the boot sequence after 30 seconds. This option is set to <b>Enabled</b> by default.</p>
<b>Hard-Disk Failover</b>	<p>Specifies the hard drive that is booted in the event of a hard drive failure. The devices are selected in the <b>Hard-Disk Drive Sequence</b> on the <b>Boot Option Setting</b> menu. When this option is set to <b>Disabled</b>, only the first hard drive in the list is attempted to boot. When this option is set to <b>Enabled</b>, all hard drives are attempted to boot in the order selected in the <b>Hard-Disk Drive Sequence</b>. This option is not enabled for UEFI Boot Mode.</p>
<b>Boot Option Settings</b>	<p>Configures the boot sequence and the boot devices.</p>
<b>BIOS Boot Settings</b>	<p>Enables or disables BIOS boot options.</p> <p> <b>NOTE:</b> This option is enabled only if the boot mode is BIOS.</p>
<b>UEFI Boot Settings</b>	<p>Enables or disables UEFI Boot options. The Boot options include <b>IPv4 PXE</b> and <b>IPv6 PXE</b>. This option is set to <b>IPv4</b> by default.</p> <p> <b>NOTE:</b> This option is enabled only if the boot mode is UEFI.</p>

## Network Settings screen details

The **Network Settings** screen details are explained as follows:

Option	Description
<b>PXE Device n (n = 1 to 4)</b>	<p>Enables or disables the device. When enabled, a UEFI boot option is created for the device.</p>
<b>PXE Device n Settings (n = 1 to 4)</b>	<p>Enables you to control the configuration of the PXE device.</p>

## UEFI iSCSI Settings screen details

You can use the iSCSI Settings screen to modify iSCSI device settings. The iSCSI Settings option is available only in the UEFI boot mode. BIOS does not control network settings in the BIOS boot mode. For BIOS boot mode, the option ROM of the network controller handles the network settings.



To view the **UEFI iSCSI Settings** screen, click **System Setup Main Menu** → **System BIOS** → **Network Settings** → **UEFI iSCSI Settings**.

The **UEFI iSCSI Settings** screen details are explained as follows:

Option	Description
<b>iSCSI Initiator Name</b>	Specifies the name of the iSCSI initiator (iqn format).
<b>iSCSI Device n (n = 1 to 4)</b>	Enables or disables the iSCSI device. When disabled, a UEFI boot option is created for the iSCSI device automatically.

## Integrated Devices details





The **Integrated Devices** screen details are explained as follows:

Option	Description
<b>User Accessible USB Ports</b>	<p>Enables or disables the USB ports. Selecting <b>Only Back Ports On</b> disables the front USB ports, selecting <b>All Ports Off</b> disables all USB ports. The USB keyboard and mouse operate during boot process in certain operating systems. After the boot process is complete, the USB keyboard and mouse do not work if the ports are disabled.</p> <p> <b>NOTE:</b> Selecting <b>Only Back Ports On</b> and <b>All Ports Off</b> disables the USB management port and also restricts access to iDRAC features.</p>
<b>Internal USB Port</b>	Enables or disables the internal USB port. This option is set to <b>Enabled</b> by default.
<b>Integrated Network Card 1</b>	Enables or disables the integrated network card.
<b>Embedded NIC1 and NIC2</b>	<p> <b>NOTE:</b> The Embedded NIC1 and NIC2 options are only available on systems that do not have <b>Integrated Network Card 1</b>.</p> <p>Enables or disables the Embedded NIC1 and NIC2 options. If set to <b>Disabled</b>, the NIC may still be available for shared network access by the embedded management controller. The embedded NIC1 and NIC2 options are only available on systems that do not have Network Daughter Cards (NDCs). The Embedded NIC1 and NIC2 option is mutually exclusive with the Integrated Network Card 1 option. Configure the Embedded NIC1 and NIC2 option by using the NIC management utilities of the system.</p>
<b>Embedded Video Controller</b>	Enables or disables the <b>Embedded Video Controller</b> option. This option is set to <b>Enabled</b> by default.
<b>Current State of Embedded Video Controller</b>	Displays the current state of the embedded video controller. The <b>Current State of Embedded Video Controller</b> option is a read-only field. If the Embedded Video Controller is the only display capability in the system (that is, no add-in graphics card is installed), then the Embedded Video Controller is automatically used as the primary display even if the <b>Embedded Video Controller</b> setting is set to <b>Disabled</b> .

Option	Description
<b>OS Watchdog Timer</b>	If your system stops responding, this watchdog timer aids in the recovery of your operating system. When this option is set to <b>Enabled</b> , the operating system initializes the timer. When this option is set to <b>Disabled</b> (the default), the timer does not have any effect on the system.
<b>Memory Mapped I/O above 4 GB</b>	Enables or disables the support for PCIe devices that need large amounts of memory. This option is set to <b>Enabled</b> by default.
<b>Slot Disablement</b>	Enables or disables the available PCIe slots on your system. The slot disablement feature controls the configuration of PCIe cards installed in the specified slot. Slots must be disabled only when the installed peripheral card prevents booting into the operating system or causes delays in system startup. If the slot is disabled, both the Option ROM and UEFI drivers are disabled.

## Serial Communication details

The **Serial Communication** screen details are explained as follows:



Option	Description
<b>Serial Communication</b>	Selects serial communication devices (Serial Device 1 and Serial Device 2) in BIOS. BIOS console redirection can also be enabled and the port address can be specified. This option is set to <b>Auto</b> by default.
<b>Serial Port Address</b>	Enables you to set the port address for serial devices. This option is set to <b>Serial Device 1=COM2, Serial Device 2=COM1</b> by default. <ul style="list-style-type: none"> <li> <b>NOTE:</b> You can use only Serial Device 2 for the Serial Over LAN (SOL) feature. To use console redirection by SOL, configure the same port address for console redirection and the serial device.</li> <li> <b>NOTE:</b> Every time the system boots, the BIOS syncs the serial MUX setting saved in iDRAC. The serial MUX setting can independently be changed in iDRAC. Loading the BIOS default settings from within the BIOS setup utility may not always revert the serial MUX setting to the default setting of Serial Device 1.</li> </ul>
<b>External Serial Connector</b>	Enables you to associate the External Serial Connector to Serial Device 1, Serial Device 2, or the Remote Access Device by using this option. <ul style="list-style-type: none"> <li> <b>NOTE:</b> Only Serial Device 2 can be used for Serial Over LAN (SOL). To use console redirection by SOL, configure the same port address for console redirection and the serial device.</li> <li> <b>NOTE:</b> Every time the system boots, the BIOS syncs the serial MUX setting saved in iDRAC. The serial MUX setting can independently be changed in iDRAC. Loading the BIOS default settings from within the BIOS setup utility may not always revert this setting to the default setting of Serial Device 1.</li> </ul>
<b>Failsafe Baud Rate</b>	Specifies the failsafe baud rate for console redirection. The BIOS attempts to determine the baud rate automatically. This failsafe baud rate is used only if the attempt fails, and the value must not be changed. This option is set to 115200 by default.
<b>Remote Terminal Type</b>	Sets the remote console terminal type. This option is set to <b>VT 100/VT 220</b> by default.



Option	Description
<b>Redirection After Boot</b>	Enables or disables the BIOS console redirection when the operating system is loaded. This option is set to <b>Enabled</b> by default.

## System Profile Settings details



The **System Profile Settings** screen details are explained as follows:

Option	Description
<b>System Profile</b>	<p>Sets the system profile. If you set the <b>System Profile</b> option to a mode other than <b>Custom</b>, the BIOS automatically sets the rest of the options. You can only change the rest of the options if the mode is set to <b>Custom</b>. This option is set to <b>Performance Per Watt (OS)</b>.</p> <p> <b>NOTE:</b> All the parameters on the system profile setting screen are available only when the <b>System Profile</b> option is set to <b>Custom</b>.</p>
<b>CPU Power Management</b>	Sets the CPU power management. This option is set to <b>OS DBPM</b> by default. DBPM is Demand-Based Power Management.
<b>Memory Frequency</b>	Sets the speed of the system memory. You can select <b>Maximum Performance</b> , <b>Maximum Reliability</b> , or a specific speed.
<b>Turbo Boost</b>	Enables or disables the processor to operate in the turbo boost mode. This option is set to <b>Enabled</b> by default.
<b>C1E</b>	Enables or disables the processor to switch to a minimum performance state when it is idle. This option is set to <b>Enabled</b> by default.
<b>C States</b>	Enables or disables the processor to operate in all available power states. This option is set to <b>Enabled</b> by default.
<b>Memory Refresh Rate</b>	Sets the memory refresh rate to either 1x or 2x. This option is set to <b>1x</b> by default.
<b>Uncore Frequency</b>	<p>Enables you to select the <b>Processor Uncore Frequency</b> option.</p> <p>Dynamic mode enables the processor to optimize power resources across the cores and uncore during runtime. The optimization of the uncore frequency to either save power or optimize performance is influenced by the setting of the <b>Energy Efficiency Policy</b> option.</p>
<b>Energy Efficient Policy</b>	<p>Enables you to select the <b>Energy Efficient Policy</b> option.</p> <p>The CPU uses the setting to manipulate the internal behavior of the processor and determines whether to target higher performance or better power savings.</p>
<b>Number of Turbo Boot Enabled Cores for Processor 1</b>	Controls the number of turbo boost enabled cores for processor 1. The maximum number of cores is enabled by default.
<b>Monitor/Mwait</b>	<p>Enables the Monitor/Mwait instructions in the processor. This option is set to <b>Enabled</b> for all system profiles, except <b>Custom</b> by default.</p> <p> <b>NOTE:</b> This option can be disabled only if the <b>C States</b> option in the <b>Custom</b> mode is set to <b>disabled</b>.</p>

Option	Description
	 <b>NOTE:</b> When <b>C States</b> is set to <b>Enabled</b> in the <b>Custom</b> mode, changing the Monitor/Mwait setting does not impact the system power or performance.

## System Security Settings details

The **System Security Settings** screen details are explained as follows:

Option	Description
<b>Intel AES-NI</b>	Improves the speed of applications by performing encryption and decryption by using the Advanced Encryption Standard Instruction Set (AES-NI). This option is set to <b>Enabled</b> by default.
<b>System Password</b>	Sets the system password. This option is set to <b>Enabled</b> by default and is read-only if the password jumper is not installed in the system.
<b>Setup Password</b>	Sets the setup password. This option is read-only if the password jumper is not installed in the system.
<b>Password Status</b>	Locks the system password. This option is set to <b>Unlocked</b> by default.
<b>TPM Security</b>	 <b>NOTE:</b> The TPM menu is available only when the TPM module is installed.  Enables you to control the reporting mode of the TPM. The <b>TPM Security</b> option is set to <b>Off</b> by default. You can only modify the TPM Status, TPM Activation, and Intel TXT fields if the <b>TPM Status</b> field is set to either <b>On with Pre-boot Measurements</b> or <b>On without Pre-boot Measurements</b> .
<b>TPM Information</b>	Changes the operational state of the TPM. This option is set to <b>No Change</b> by default.
<b>TPM Status</b>	Specifies the TPM status.
<b>TPM Command</b>	 <b>CAUTION: Clearing the TPM results in the loss of all keys in the TPM. The loss of TPM keys may affect booting to the operating system.</b>  Clears all the contents of the TPM. The <b>TPM Clear</b> option is set to <b>No</b> by default.
<b>Intel TXT</b>	Enables or disables the Intel Trusted Execution Technology (TXT) option. To enable the <b>Intel TXT</b> option, virtualization technology and TPM Security must be enabled with Pre-boot measurements. This option is set to <b>Off</b> by default.
<b>Power Button</b>	Enables or disables the power button on the front of the system. This option is set to <b>Enabled</b> by default.
<b>NMI Button</b>	Enables or disables the NMI button on the front of the system. This option is set to <b>Disabled</b> by default.
<b>AC Power Recovery</b>	Sets how the system behaves after AC power is restored to the system. This option is set to <b>Last</b> by default.
<b>AC Power Recovery Delay</b>	Sets the time delay for the system to power up after AC power is restored to the system. This option is set to <b>Immediate</b> by default.
<b>User Defined Delay (60s to 240s)</b>	Sets the <b>User Defined Delay</b> option when the <b>User Defined</b> option for <b>AC Power Recovery Delay</b> is selected.

Option	Description
<b>UEFI Variable Access</b>	Provides varying degrees of securing UEFI variables. When set to <b>Standard</b> (the default), UEFI variables are accessible in the operating system per the UEFI specification. When set to <b>Controlled</b> , selected UEFI variables are protected in the environment and new UEFI boot entries are forced to be at the end of the current boot order.
<b>Secure Boot</b>	Enables Secure Boot, where the BIOS authenticates each pre-boot image by using the certificates in the Secure Boot Policy. Secure Boot is disabled by default.
<b>Secure Boot Policy</b>	When Secure Boot policy is set to <b>Standard</b> , the BIOS uses the system manufacturer's key and certificates to authenticate pre-boot images. When Secure Boot policy is set to <b>Custom</b> , the BIOS uses the user-defined key and certificates. Secure Boot policy is set to <b>Standard</b> by default.
<b>Secure Boot Policy Summary</b>	Specifies the list of certificates and hashes that secure boot uses to authenticate images.

### Secure Boot Custom Policy Settings screen details

Secure Boot Custom Policy Settings is displayed only when the **Secure Boot Policy** option is set to **Custom**.

To view the **Secure Boot Custom Policy Settings** screen, click **System Setup Main Menu** → **System BIOS** → **System Security** → **Secure Boot Custom Policy Settings**.

The **Secure Boot Custom Policy Settings** screen details are explained as follows:

Option	Description
<b>Platform Key</b>	Imports, exports, deletes, or restores the platform key (PK).
<b>Key Exchange Key Database</b>	Enables you to import, export, delete, or restore entries in the Key Exchange Key (KEK) Database.
<b>Authorized Signature Database</b>	Imports, exports, deletes, or restores entries in the Authorized Signature Database (db).
<b>Forbidden Signature Database</b>	Imports, exports, deletes, or restores entries in the Forbidden Signature Database (dbx).

### Miscellaneous Settings details

The **Miscellaneous Settings** screen details are explained as follows:

Option	Description
<b>System Time</b>	Enables you to set the time on the system.
<b>System Date</b>	Enables you to set the date on the system.
<b>Asset Tag</b>	Specifies the asset tag and enables you to modify it for security and tracking purposes.
<b>Keyboard NumLock</b>	Enables you to set whether the system boots with the NumLock enabled or disabled. This option is set to <b>On</b> by default.

 **NOTE:** This option does not apply to 84-key keyboards.

Option	Description
<b>F1/F2 Prompt on Error</b>	Enables or disables the F1/F2 prompt on error. This option is set to <b>Enabled</b> by default. The F1/F2 prompt also includes keyboard errors.
<b>Load Legacy Video Option ROM</b>	Enables you to determine whether the system BIOS loads the legacy video (INT 10H) option ROM from the video controller. Selecting <b>Enabled</b> in the operating system does not support UEFI video output standards. This field is available only for UEFI boot mode. You cannot set the option to <b>Enabled</b> if <b>UEFI Secure Boot</b> mode is enabled.
<b>In-System Characterization</b>	<p>Enables or disables <b>In-System Characterization</b>. This option is set to <b>Disabled</b> by default. The two other options are <b>Enabled</b> and <b>Enabled - No Reboot</b>.</p> <p> <b>NOTE:</b> The default setting for <b>In-System Characterization</b> is subject to change in future BIOS releases.</p> <p>When enabled, In-System Characterization (ISC) executes during POST upon detecting relevant change(s) in system configuration to optimize system power and performance. ISC takes about 20 seconds to execute, and system reset is needed for ISC results to be applied. The <b>Enabled - No Reboot</b> option executes ISC and continues without applying ISC results until the next time system reset occurs. The <b>Enabled</b> option executes ISC and forces an immediate system reset so that ISC results can be applied. It takes the system longer to be ready due to the forced system reset. When disabled, ISC does not execute.</p>

## About Boot Manager

Boot manager enables you to add, delete, and arrange boot options. You can also access System Setup and boot options without restarting the system.

### Viewing Boot Manager

To enter **Boot Manager**:

1. Turn on, or restart your system.
2. Press F11 when you see the following message:

F11 = Boot Manager

If your operating system begins to load before you press F11, allow the system to complete the booting, and then restart your system and try again.

### Boot Manager main menu

Menu item	Description
<b>Continue Normal Boot</b>	The system attempts to boot to devices starting with the first item in the boot order. If the boot attempt fails, the system continues with the next item in the boot order until the boot is successful or no more boot options are found.
<b>One-shot Boot Menu</b>	Enables you to access boot menu, where you can select a one-time boot device to boot from.
<b>Launch System Setup</b>	Enables you to access System Setup.

Menu item	Description
<b>Launch Lifecycle Controller</b>	Exits the Boot Manager and invokes the Dell Lifecycle Controller program.
<b>System Utilities</b>	Enables you to launch System Utilities menu such as System Diagnostics and UEFI shell.

## About Dell Lifecycle Controller

Dell Lifecycle Controller enables you to perform tasks such as configuring BIOS and hardware settings, deploying an operating system, updating drivers, changing RAID settings, and saving hardware profiles. For more information about Dell Lifecycle Controller, see the documentation at [Dell.com/idracmanuals](http://Dell.com/idracmanuals).

## Changing the boot order

You may have to change the boot order if you want to boot from a USB key or an optical drive. The following instructions may vary if you have selected **BIOS** for **Boot Mode**.

1. On the **System Setup Main Menu** screen, click **System BIOS** → **Boot Settings**.
2. Click **Boot Option Settings** → **Boot Sequence**.
3. Use the arrow keys to select a boot device, and use the plus (+) and minus (-) sign keys to move the device down or up in the order.
4. Click **Exit**, and then click **Yes** to save the settings on exit.

## Choosing the system boot mode

System Setup enables you to specify one of the following boot modes for installing your operating system:

- BIOS boot mode (the default) is the standard BIOS-level boot interface.
- Unified Extensible Firmware Interface (UEFI) boot mode is an enhanced 64-bit boot interface. If you have configured your system to boot to UEFI mode, it replaces the system BIOS.

1. From the **System Setup Main Menu**, click **Boot Settings**, and select **Boot Mode**.
2. Select the boot mode you want the system to boot into.

 **CAUTION: Switching the boot mode may prevent the system from booting if the operating system is not installed in the same boot mode.**

3. After the system boots in the specified boot mode, proceed to install your operating system from that mode.

 **NOTE:** Operating systems must be UEFI-compatible to be installed from the UEFI boot mode. DOS and 32-bit operating systems do not support UEFI and can only be installed from the BIOS boot mode.

 **NOTE:** For the latest information about supported operating systems, go to [Dell.com/ossupport](http://Dell.com/ossupport).

# Creating a system or setup password

## Prerequisites

- Ensure that the password jumper setting is enabled. The password jumper enables or disables the system password and setup password features. For more information about the password jumper settings, see [System board jumpers and connectors](#).
- Ensure that password status is unlocked in the **System Security Settings** screen. For more information, see [System Security Settings details](#).

 **NOTE:** If the password jumper setting is disabled, the existing system password and setup password are deleted and you need not provide the system password to boot the system.

## Steps

1. To enter system setup, press F2 immediately after turning on or restarting the system.
2. On the **System Setup Main Menu** screen, click **System BIOS** → **System Security**.
3. On the **System Security** screen, verify that **Password Status** is set to **Unlocked**.
4. In the **System Password** field, type your system password, and then press Enter or Tab.  
Use the following guidelines to assign the system password:
  - A password can have up to 32 characters.
  - The password can contain the numbers 0 through 9.
  - Only the following special characters are allowed: space, ("), (+), (,), (-), (.), (/), (:), (D), (\), (I), (').

A message prompts you to reenter the system password.

5. Reenter the system password, and click **OK**.
6. In the **Setup Password** field, type your system password, and then press Enter or Tab.  
A message prompts you to reenter the setup password.
7. Reenter the setup password, and click **OK**.
8. Press Esc to return to the **System BIOS** screen. Press Esc again.  
A message prompts you to save the changes.

 **NOTE:** Password protection does not take effect until the system reboots.

# Using your system password to secure your system

If you have assigned a setup password, the system accepts your setup password as an alternate system password.

## Steps

1. Turn on or reboot your system.
2. Type the system password and press Enter.

## Next steps

When **Password Status** is set to **Locked**, type the system password and press Enter when prompted at reboot.

 **NOTE:** If an incorrect system password is typed, the system displays a message and prompts you to reenter your password. You have three attempts to type the correct password. After the third unsuccessful attempt, the system displays an error message that the system has stopped functioning and must be turned off. Even after you turn off and restart the system, the error message is displayed until the correct password is entered.

## Deleting or changing system and setup password

### Prerequisites

 **NOTE:** You cannot delete or change an existing system or setup password if the **Password Status** is set to **Locked**.

### Steps

1. To enter System Setup, press F2 immediately after turning on or restarting your system.
2. On the **System Setup Main Menu** screen, click **System BIOS** → **System Security**.
3. On the **System Security** screen, ensure that **Password Status** is set to **Unlocked**.
4. In the **System Password** field, alter or delete the existing system password, and then press Enter or Tab.
5. In the **Setup Password** field, alter or delete the existing setup password, and then press Enter or Tab. If you change the system and setup password, a message prompts you to reenter the new password. If you delete the system and setup password, a message prompts you to confirm the deletion.
6. Press Esc to return to the **System BIOS** screen. Press Esc again, and a message prompts you to save the changes.

## Operating with a setup password enabled

If **Setup Password** is set to **Enabled**, type the correct setup password before modifying the system setup options.

If you do not type the correct password in three attempts, the system displays the following message:

```
Invalid Password! Number of unsuccessful password attempts: <x> System Halted!  
Must power down.
```

Even after you turn off and restart the system, the error message is displayed until the correct password is typed. The following options are exceptions:

- If **System Password** is not set to **Enabled** and is not locked through the **Password Status** option, you can assign a system password. For more information, see the System Security Settings screen section.
- You cannot disable or change an existing system password.

 **NOTE:** You can use the password status option with the setup password option to protect the system password from unauthorized changes.

## Embedded system management

The Dell Lifecycle Controller provides advanced embedded systems management throughout the system's lifecycle. The Dell Lifecycle Controller can be started during the boot sequence and can function independently of the operating system.

 **NOTE:** Certain platform configurations may not support the full set of features provided by the Dell Lifecycle Controller.

For more information about setting up the Dell Lifecycle Controller, configuring hardware and firmware, and deploying the operating system, see the Dell Lifecycle Controller documentation at [Dell.com/idracmanuals](https://www.dell.com/support/manuals).

## iDRAC Settings utility

The iDRAC settings utility is an interface to set up and configure the iDRAC parameters by using UEFI. You can enable or disable various iDRAC parameters by using the iDRAC settings utility.

 **NOTE:** Accessing some of the features on the iDRAC settings utility needs the iDRAC Enterprise License upgrade.

For more information about using iDRAC, see *Dell Integrated Dell Remote Access Controller User's Guide* at [Dell.com/idracmanuals](https://www.dell.com/support/manuals).

### Entering the iDRAC Settings utility

1. Turn on or restart the managed system.
2. Press F2 during Power-on Self-test (POST).
3. On the **System Setup Main Menu** page, click **iDRAC Settings**.  
The **iDRAC Settings** screen is displayed.

### Changing the thermal settings







The iDRAC settings utility enables you to select and customize the thermal control settings for your system.

1. Click **iDRAC Settings** → **Thermal**.
2. Under **SYSTEM THERMAL PROFILE** → **Thermal Profile**, select one of the following options:
  - Default Thermal Profile Settings
  - Maximum Performance (Performance Optimized)
  - Minimum Power (Performance per Watt Optimized)
3. Under **USER COOLING OPTIONS**, set the **Fan Speed Offset**, **Minimum Fan Speed**, and **Custom Minimum Fan Speed**.
4. Click **Back** → **Finish** → **Yes**.



# Installing and removing system components

## Safety instructions

-  **WARNING:** Whenever you need to lift the system, get others to assist you. To avoid injury, do not attempt to lift the system by yourself.
-  **WARNING:** Opening or removing the system cover while the system is powered on may expose you to a risk of electric shock.
-  **CAUTION:** Do not operate the system without the cover for a duration exceeding five minutes.
-  **CAUTION:** Many repairs may only be done by a certified service technician. You should only perform troubleshooting and simple repairs as authorized in your product documentation, or as directed by the online or telephone service and support team. Damage due to servicing that is not authorized by Dell is not covered by your warranty. Read and follow the safety instructions that are shipped with your product.
-  **CAUTION:** Operating the system without the system cover can result in component damage.
-  **NOTE:** Dell recommends that you always use a static mat and static strap while working on components inside the system.
-  **NOTE:** To ensure proper operation and cooling, all bays in the system and system fans must be populated always with either a component or with a blank.

## Before working inside your system

### Prerequisites

Ensure that you follow the [Safety instructions](#).

### Steps

1. Turn off the system and any attached peripherals.
2. Disconnect the system from the electrical outlet and peripherals.
3. If applicable, remove the system from the rack. For more information, see the Rack Installation placemat at [Dell.com/poweredgemanuals](https://Dell.com/poweredgemanuals).
4. If installed, remove the optional front bezel.
5. Place the system on its side.
6. Remove the system cover.

### Related Links

[Removing the optional front bezel](#)

[Removing the system cover](#)

## After working inside your system

1. Install the system cover.
2. Place the system upright on its feet on a flat and stable surface.
3. Install the optional bezel.
4. If applicable, install the system into the rack. For more information, see the Rack installation placemat at [Dell.com/poweredgemanuals](https://www.dell.com/poweredgemanuals).
5. Reconnect the system to an electrical outlet and peripherals.
6. Turn on the system and any attached peripherals.

### Related Links

[Installing the system cover](#)

[Installing the optional front bezel](#)

## Recommended tools

You need the following tools to perform the removal and installation procedures:

- Keys to the bezel lock
- Phillips #2 screwdriver
- Wrist strap
- Plastic scribe

## Front bezel (optional)

The front bezel is attached to the front side of the server and prevents accidents while removing the hard drive or when pressing the reset or power button. The front bezel can also be locked for additional security.

### Installing the optional front bezel

1. Locate and remove the bezel keys.
  -  **NOTE:** There are two bezel keys attached to the back of the bezel.
2. Press the release latch, and push the bezel toward the system until the bezel locks into place.
3. Lock the bezel by using the key.

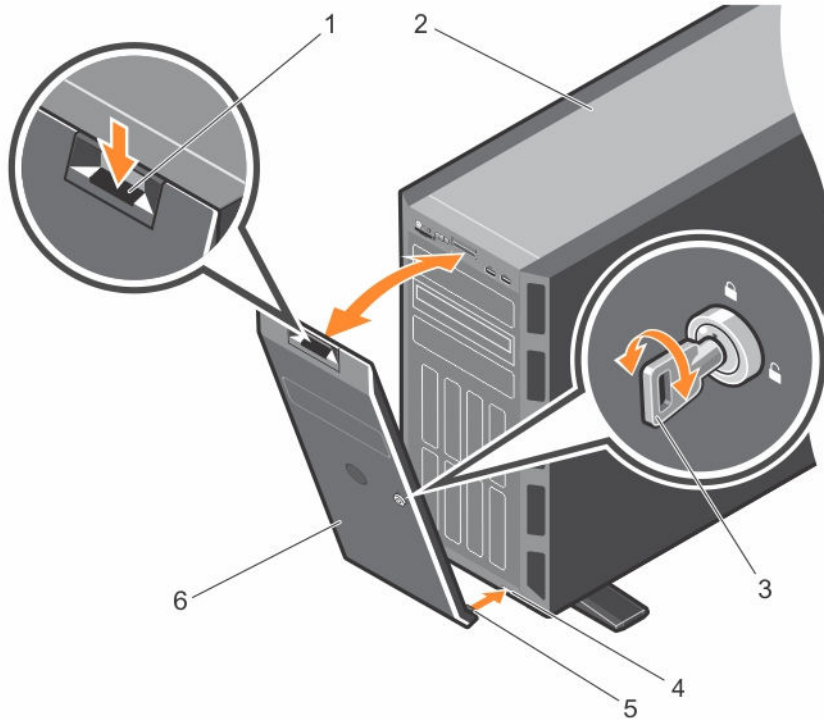

**Figure 10. Installing and removing the optional front bezel**

- |                  |                            |
|------------------|----------------------------|
| 1. release latch | 2. system                  |
| 3. bezel key     | 4. slot on the chassis (2) |
| 5. bezel tab (2) | 6. bezel                   |

## Removing the optional front bezel

1. Unlock the bezel using the bezel keys.
2. Press the release latch at the top of the bezel.
3. Pull the top end of the bezel away from the system.
4. Unhook the bezel tabs from the slots at the bottom of the system board, and pull the bezel away from the system.

## System feet

The system feet provide stability to the system in the tower mode.

### Removing the system feet

#### Prerequisites

**NOTE:** It is recommended that you remove the system feet only when you are converting the system from the tower mode to the rack mode, or when you are replacing the system feet with the wheel assembly.

1. Ensure that you follow the [Safety instructions](#).
2. Keep the Phillips #2 screwdriver ready.

3. Turn the system feet inward.
4. Place the system on its side on a flat and stable surface.

### Steps

Remove the screws securing the system feet to the base of the tower.

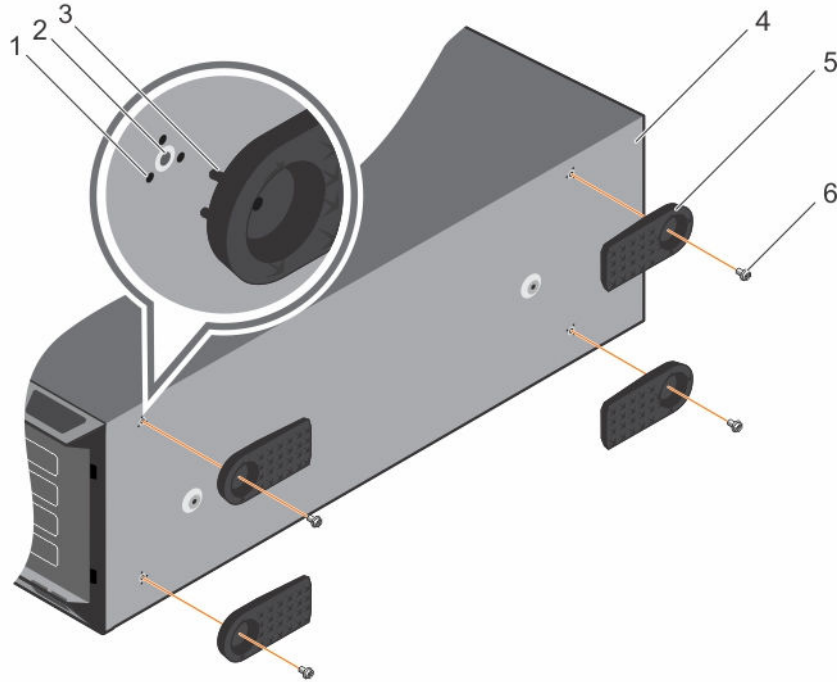

**Figure 11. Removing and installing the system feet**

- |                    |                      |
|--------------------|----------------------|
| 1. screw hole (4)  | 2. slot (12)         |
| 3. tab (12)        | 4. base of the tower |
| 5. system feet (4) | 6. screw (4)         |

### Related Links

[Installing the system feet](#)

## Installing the system feet

### Prerequisites

**⚠ CAUTION: Installing the feet on a stand-alone tower system is necessary to provide a stable foundation for the system. Failure to install the feet poses the risk of having the system tip over, possibly causing bodily injury or damage to the system.**

1. Ensure that you follow the [Safety instructions](#).
2. Keep the Phillips #2 screwdriver ready.
3. Place the system on its side on a flat and stable surface.

### Steps

1. Align the tabs on the system feet with the slots on the base of the chassis.
2. Secure the system feet to the base of the chassis by using the screws.

### Next steps

Place the system upright on a flat and stable surface, and turn the system feet outward.

### Related Links

[Removing the system feet](#)

[Removing the system feet](#)

## Caster wheels (optional)—tower mode

Caster wheels provide mobility to the system in the tower mode.

The caster wheel assembly consists of:

- Caster wheel units (front and back)
- Two screws for the caster wheel units

### Installing caster wheels

#### Prerequisites

1. Ensure that you follow the [Safety instructions](#).
2. Keep the Phillips #2 screwdriver ready.
3. Place the system on its side on a flat and stable surface with the base of the system extending off the edge of the surface.
4. If installed, remove the system feet.

#### Steps

1. Align the retention hooks on the back wheel unit with the slots on the base of the chassis, and insert the hooks into the slots.
2. Slide the back wheel to the back of the system and secure the unit in place using a screw.
3. Align the retention hooks on the front wheel with the slots on the base of the chassis, and insert the hooks into the slots.
4. Slide the front wheel to the front of the system, and secure the unit in place using a screw.

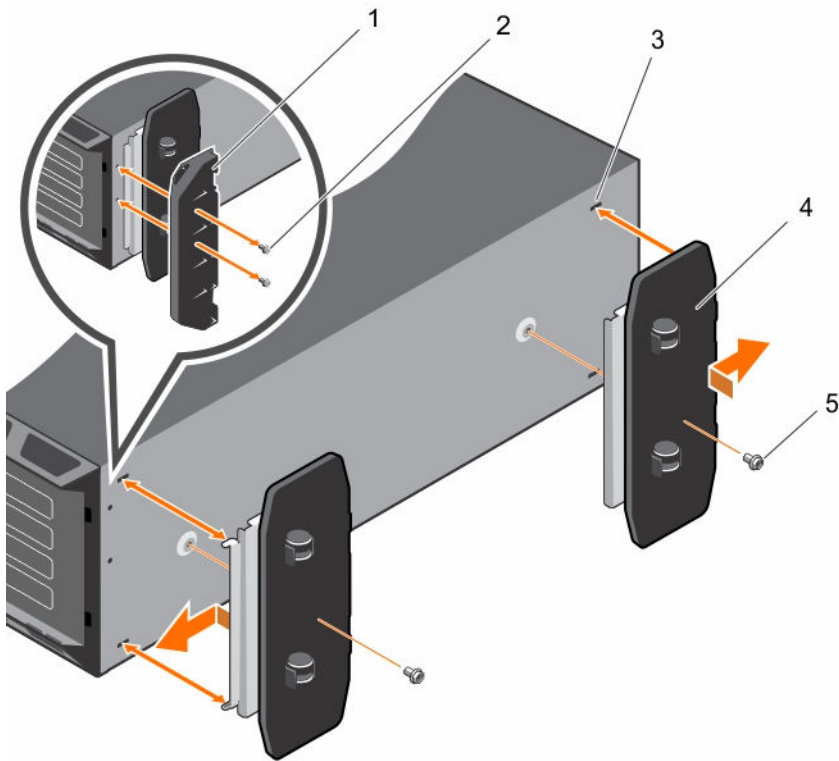

**Figure 12. Removing and installing caster wheels**

- |                                  |                               |
|----------------------------------|-------------------------------|
| 1. support unit                  | 2. screw for support unit (2) |
| 3. slot on base of the tower (4) | 4. wheel assembly unit (2)    |
| 5. screw for wheel assembly (2)  |                               |

#### Related Links

[Removing the system feet](#)

[Removing caster wheels](#)

## Removing caster wheels

#### Prerequisites

1. Ensure that you follow the [Safety instructions](#).
2. Keep the Phillips #2 screwdriver ready.
3. Place the system on a flat and stable surface with the wheels extending beyond the edge of the surface.

#### Steps

1. Remove the screw that secures the front wheel unit to the base of the chassis.
2. Slide the front wheel unit slightly to the back of the system to release the retention hooks, and pull the front wheel unit.
3. Remove the screw securing the back wheel unit to the base of the chassis.
4. Slide the back wheel unit slightly to the front of the system to release the retention hooks, and pull the back wheel unit.

## Related Links

[Installing caster wheels](#)

# System cover

The system cover protects the components inside the system and helps in maintaining air flow inside the system. Removing the system cover actuates the intrusion switch which aids in maintaining system security.

## Removing the system cover

### Prerequisites

1. Ensure that you follow the [Safety instructions](#).
2. Turn off the system and any attached peripherals.
3. Disconnect the system from the electrical outlet and peripherals.
4. If installed, remove the front bezel.
5. Place the system on a flat and stable surface.

### Steps

1. Turn the latch release lock to the unlocked position.
2. Press the cover release latch and remove the system cover.

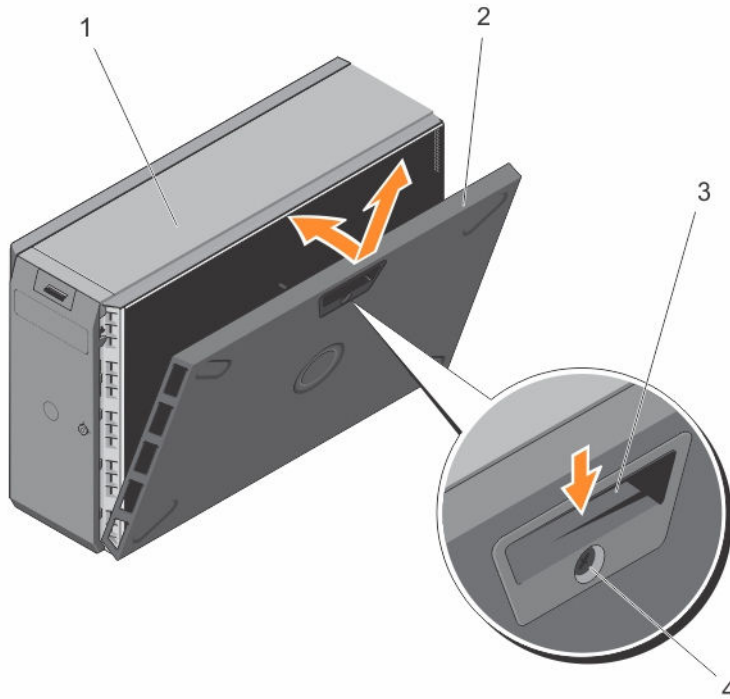

**Figure 13. Removing and installing the system cover**

- |                        |                             |
|------------------------|-----------------------------|
| 1. system              | 2. system cover             |
| 3. cover release latch | 4. cover release latch lock |

**Next steps**

Install the system cover.

**Related Links**

[Removing the optional front bezel](#)

[Installing the system cover](#)

**Installing the system cover****Prerequisites**

Ensure that you follow the [Safety instructions](#).

**Steps**

1. Align the slots on the system cover with the tabs on the chassis.
2. Press the cover release latch, and push the cover toward the chassis until the latch locks into place.
3. Turn the cover release latch lock to the locked position.

**Next steps**

1. Place the system upright on its feet on a flat and stable surface.
2. If removed, install the front bezel.
3. Reconnect the system to the electrical outlet and peripherals.
4. Turn on the system and any attached peripherals.

**Related Links**

[Installing the optional front bezel](#)



## Inside the system

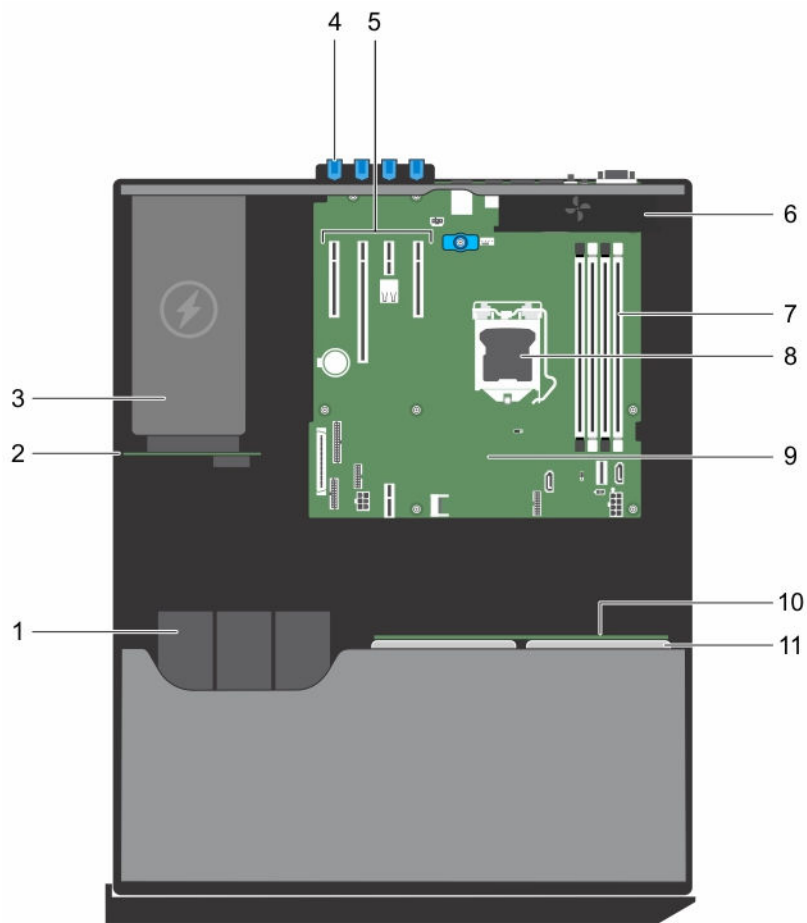

**Figure 14. Inside the system**

- |                                |                           |
|--------------------------------|---------------------------|
| 1. optical drive or tape drive | 2. power interposer board |
| 3. power supply unit           | 4. expansion card latch   |
| 5. expansion card slots        | 6. cooling fan            |
| 7. memory module slots         | 8. processor              |
| 9. system board                | 10. hard drive backplane  |
| 11. hard drive                 |                           |

## Optical drives and tape drives (optional)

Systems with hot swappable hard drives support up to one optical drive and two tape drives.

 **NOTE:** You can also install a Dell PowerVault RD1000 removable media device on your system.

For systems with hot swappable hard drives, the optical and tape drives can be configured as follows:

Slot 1	SATA optical drive or PowerVault RD1000
Slot 2	PowerVault RD1000 or blank
Slot 3	SAS tape drive or blank



## Removing the optional optical drive or tape drive

### Prerequisites

 **CAUTION:** Many repairs may only be done by a certified service technician. You should only perform troubleshooting and simple repairs as authorized in your product documentation, or as directed by the online or telephone service and support team. Damage due to servicing that is not authorized by Dell is not covered by your warranty. Read and follow the safety instructions that are shipped with your product.

1. Ensure that you follow the [Safety instructions](#).
2. Follow the procedure listed in [Before working inside your system](#).

### Steps

1. Disconnect the power and data cables from the back of the optical drive or tape drive.
  -  **NOTE:** Note the routing of the power and data cable inside the chassis when you remove them from the system board and the optical drive or tape drive. You must route these cables correctly and in a similar manner when you replace them to prevent them from being pinched or crimped.
2. If required, disconnect the power cable from the backplane and disconnect the data cable from the system board.
3. Press the release latch in the direction of the arrow.
4. Slide the optical drive or tape drive out of the drive bay.
5. If you are not immediately replacing the optical drive or tape drive, install the optical drive or tape drive blank.
  -  **NOTE:** Blanks must be installed on empty optical drive or tape drive slots to maintain FCC certification of the system. The blanks also keep dust and dirt out of the system and aid in proper cooling and airflow inside the system.
  -  **NOTE:** The procedure to install an optical drive or tape drive blank is similar to the procedure to install an optical drive or tape drive.

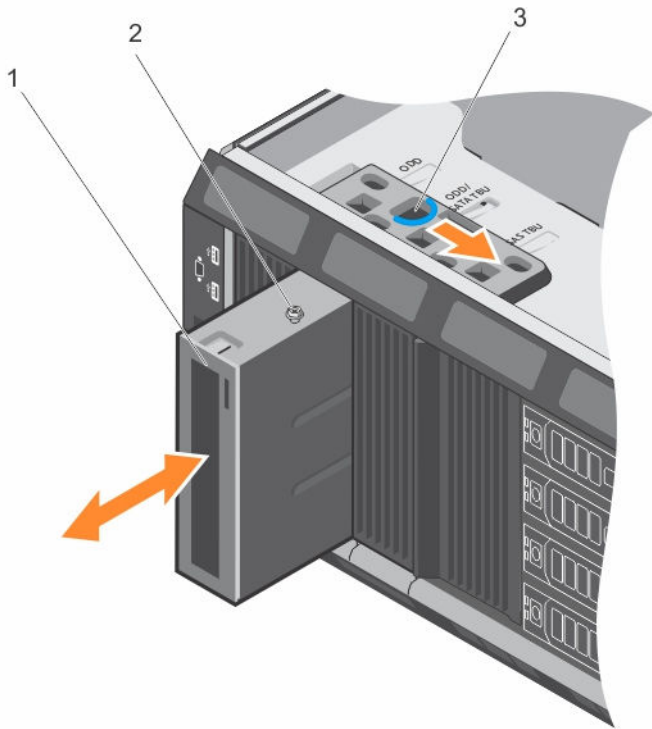

**Figure 15. Removing and installing the optional optical drive or tape drive**

1. optical drive or tape drive
2. guide
3. release latch

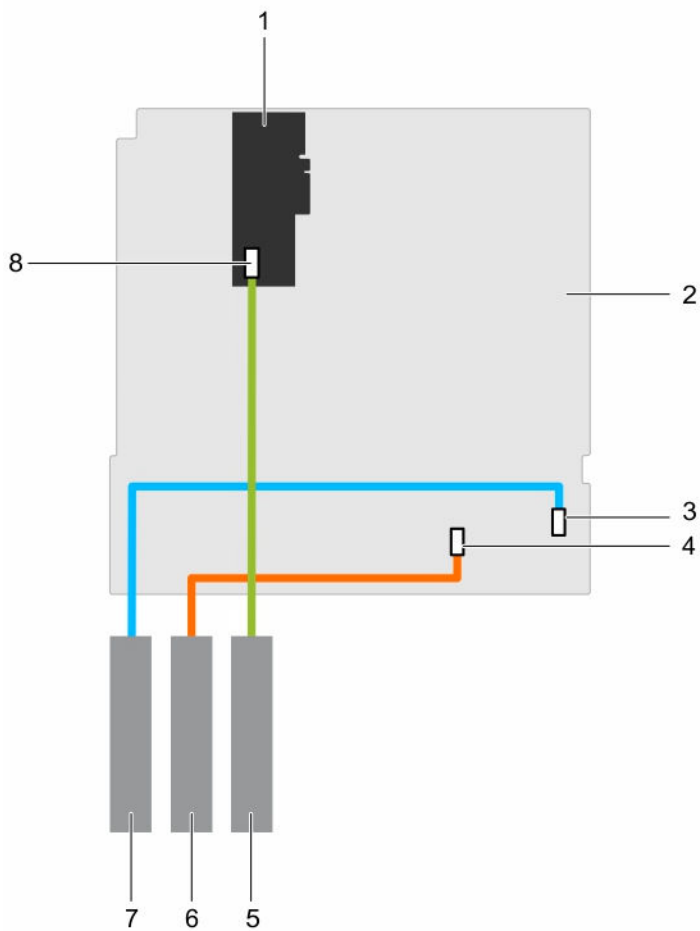

**Figure 16. Cabling— optical drive and tape drive**

- |   |  |
|---|--|
| 1. PERC card  | 2. system board                                  |
| 3. optical disk drive connector on the system board | 4. SATA tape drive connector on the system board |
| 5. SAS tape drive                                   | 6. optical disk drive or SATA tape drive         |
| 7. optical disk drive                               | 8. SAS tape drive connector on the PERC card     |

**Next steps**

1. Install the optical drive or tape drive.
2. Follow the procedure listed in [After working inside your system.](#)

**Related Links**

[Installing the optical drive or tape drive](#)

## Installing the optical drive or tape drive

### Prerequisites

 **CAUTION:** Many repairs may only be done by a certified service technician. You should only perform troubleshooting and simple repairs as authorized in your product documentation, or as directed by the online or telephone service and support team. Damage due to servicing that is not authorized by Dell is not covered by your warranty. Read and follow the safety instructions that are shipped with your product.

1. Ensure that you follow the [Safety instructions](#).
2. Follow the procedure listed in [Before working inside your system](#).

### Steps

1. Unpack and prepare the drive for installation.  
For instructions, see the documentation that accompanied the drive.

 **NOTE:** If you are installing a SAS tape drive, you must have an internal tape adapter installed.

2. If installed, remove the old drive or the drive blank.
3. Align the guide on the drive with the slot on the drive bay.
4. Slide the optical drive or tape drive into the slot until the optical drive or tape drive snaps into place.
5. Connect the power and data cables to the back of the optical drive or tape drive.
6. Connect the power cable to the backplane and connect the data cable to the system board.

### Next steps

Follow the procedure listed in [After working inside your system](#).

## Cooling shroud

The cooling shroud has aerodynamically placed openings that direct the airflow across the entire system. The airflow passes through all the critical parts of the system, where the vacuum pulls air across the entire surface area of the heat sink, thus allowing increased cooling.

## Removing the cooling shroud

### Prerequisites

 **CAUTION:** Many repairs may only be done by a certified service technician. You should only perform troubleshooting and simple repairs as authorized in your product documentation, or as directed by the online or telephone service and support team. Damage due to servicing that is not authorized by Dell is not covered by your warranty. Read and follow the safety instructions that are shipped with your product.

 **CAUTION:** Never operate your system with the cooling shroud removed. The system may get overheated quickly, resulting in shutdown of the system and loss of data.

1. Ensure that you follow the [Safety instructions](#).
2. Follow the procedure listed in [Before working inside your system](#).

### Steps

Holding the touch points, lift the cooling shroud away from the system.

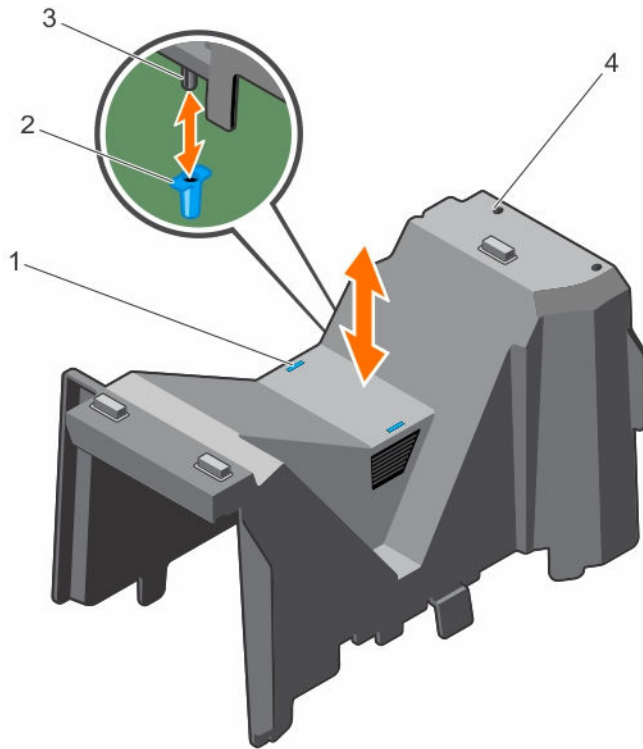

**Figure 17. Removing and installing the cooling shroud**

- |                                    |                                      |
|------------------------------------|--------------------------------------|
| 1. touch point (2)                 | 2. t-handle post on the system board |
| 3. guide pin on the cooling shroud | 4. slot (2)                          |

#### Next steps

1. Install the cooling shroud.
2. Follow the procedure listed in [After working inside your system](#) .

#### Related Links

[Installing the cooling shroud](#)

## Installing the cooling shroud

#### Prerequisites

**⚠ CAUTION:** Many repairs may only be done by a certified service technician. You should only perform troubleshooting and simple repairs as authorized in your product documentation, or as directed by the online or telephone service and support team. Damage due to servicing that is not authorized by Dell is not covered by your warranty. Read and follow the safety instructions that are shipped with your product.

1. Ensure that you follow the [Safety instructions](#).
2. Follow the procedure listed in [Before working inside your system](#).

**⚠ CAUTION:** Do not operate the system with the cover removed for a duration exceeding 5 minutes.

 **NOTE:** For proper seating of the cooling shroud in the system chassis, ensure that the cables inside the system are routed along the chassis wall and secured using the cable securing clips.

#### Steps

1. Align the slots on the cooling shroud with the tabs on the internal cooling fan.
2. Lower the cooling shroud into the system until the slots on the cooling shroud are flush with the tabs on the internal cooling fan.

 **NOTE:** When the cooling shroud is properly seated, the guide pin on the cooling shroud engages with the t-handle post on the system board.

#### Next steps

Follow the procedure listed in [After working inside your system](#) .

## Intrusion switch

### Removing the intrusion switch

#### Prerequisites

 **CAUTION:** Many repairs may only be done by a certified service technician. You should only perform troubleshooting and simple repairs as authorized in your product documentation, or as directed by the online or telephone service and support team. Damage due to servicing that is not authorized by Dell is not covered by your warranty. Read and follow the safety instructions that are shipped with your product.

1. Ensure that you follow the [Safety instructions](#).
2. Follow the procedure listed in [Before working inside your system](#).
3. Remove the cooling shroud.

#### Steps

1. Disconnect the intrusion switch cable from the intrusion switch connector on the system board.
2. Press the intrusion switch and slide it out of the intrusion switch slot.

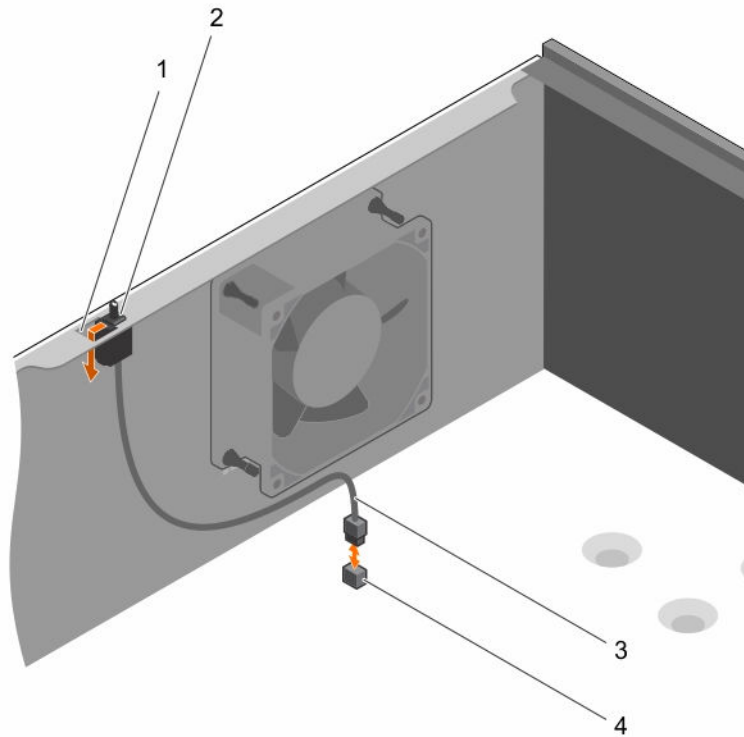

**Figure 18. Removing and installing the intrusion switch**

- |                           |   |
|---------------------------|---|
| 1. intrusion switch slot  | 2. intrusion switch                               |
| 3. intrusion switch cable | 4. intrusion switch connector on the system board |

#### Next steps

1. Install the intrusion switch.
2. Follow the procedure listed in [After working inside your system](#) .

#### Related Links

[Removing the cooling shroud](#)

[Installing the intrusion switch](#)

## Installing the intrusion switch

#### Prerequisites

**⚠ CAUTION:** Many repairs may only be done by a certified service technician. You should only perform troubleshooting and simple repairs as authorized in your product documentation, or as directed by the online or telephone service and support team. Damage due to servicing that is not authorized by Dell is not covered by your warranty. Read and follow the safety instructions that are shipped with your product.

1. Ensure that you follow the [Safety instructions](#).
2. Follow the procedure listed in [Before working inside your system](#).



## Steps

1. Slide the intrusion switch into the intrusion switch slot.
2. Connect the intrusion switch cable to the intrusion switch connector on the system board.

## Next steps

1. Install the cooling shroud.
2. Follow the procedure listed in [After working inside your system](#).

## Related Links

[Installing the cooling shroud](#)

# Hard drives

Your system supports enterprise class hard drives. Enterprise class drives are designed for 24x7 operating environment. Selecting the correct drive class enables the critical areas of quality, functionality, performance, and reliability to be optimized for the target implementation.

Choosing the right drive type depends on the usage pattern. Due to industry advances, in some cases, the larger capacity drives have been changed to a larger sector size. The larger sector size can have impacts on operating systems and applications. For more information about these hard drives, see the *512e and 4Kn Disk Formats* whitepaper and *4K Sector HDD FAQ* document at [Dell.com/poweredge manuals](http://Dell.com/poweredge manuals).

 **CAUTION: Before attempting to remove or install a hard drive while the system is running, see the documentation for the storage controller card to ensure that the host adapter is configured correctly to support hot swappable hard drive removal and insertion.**

 **CAUTION: Do not turn off or restart your system while the hard drive is being formatted. Doing so can cause a hard drive failure.**

Use only hard drives that have been tested and approved for use with the hard drive backplane.

When you format a hard drive, allow enough time for the formatting to be completed. Be aware that high-capacity hard drives can take a long time to format.

## Supported hard drive configurations

Depending on the configuration, your system supports one of the following:

**Four hard drive systems**      Up to four 3.5-inch (2.5-inch with adapter) hot swappable SAS, SATA and nearline SAS hard drives/solid state drives

**Eight hard drive systems**      Up to eight 3.5-inch (2.5-inch with adapter) hot swappable SAS, SATA and nearline SAS hard drives/solid state drives

 **NOTE:** SAS/SATA hard drives cannot be mixed in a system.

The hot swappable hard drives connect to the system board through the hard drive backplane. Hot swappable hard drives are supplied in hot swappable hard drive carriers that fit in the hard drive slots.

## Removing a 3.5-inch hot swappable hard drive carrier blank

### Prerequisites

△ **CAUTION:** Many repairs may only be done by a certified service technician. You should only perform troubleshooting and simple repairs as authorized in your product documentation, or as directed by the online or telephone service and support team. Damage due to servicing that is not authorized by Dell is not covered by your warranty. Read and follow the safety instructions that came with the product.

△ **CAUTION:** To maintain proper system cooling, all empty hard drive slots must have drive carrier blanks installed.

1. Ensure that you follow the [Safety instructions](#).
2. If installed, remove the front bezel.

### Steps

Press the release button and slide the hard drive carrier blank out of the hard drive slot.

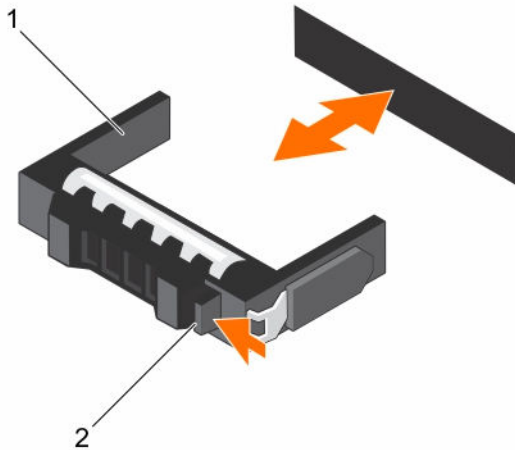

Figure 19. Removing and installing a 3.5-inch hot swappable hard drive carrier blank

1. hard drive carrier blank
2. release button

### Next steps

If removed, install the front bezel.

### Related Links

[Removing the optional front bezel](#)

[Installing the optional front bezel](#)

## Installing a 3.5-inch hot swappable hard drive carrier blank

### Prerequisites

△ **CAUTION:** Many repairs may only be done by a certified service technician. You should only perform troubleshooting and simple repairs as authorized in your product documentation, or as directed by the online or telephone service and support team. Damage due to servicing that is not authorized by Dell is not covered by your warranty. Read and follow the safety instructions that came with the product.

1. Ensure that you follow the [Safety instructions](#).
2. If installed, remove the front bezel.

### Steps

Insert the hard drive carrier blank into the hard drive slot, and push the hard drive carrier blank until the release button clicks into place.

### Next steps

If removed, install the front bezel.

### Related Links

[Removing the optional front bezel](#)

[Installing the optional front bezel](#)

## Removing a hot swappable hard drive carrier

### Prerequisites

 **CAUTION:** Many repairs may only be done by a certified service technician. You should only perform troubleshooting and simple repairs as authorized in your product documentation, or as directed by the online or telephone service and support team. Damage due to servicing that is not authorized by Dell is not covered by your warranty. Read and follow the safety instructions that came with the product.

1. Ensure that you follow the [Safety instructions](#).
2. If installed, remove the front bezel.
3. Using the management software, prepare the hard drive for removal. For more information, see the documentation for the storage controller.

If the hard drive is online, the green activity or fault indicator flashes when the hard drive is turned off. You can remove the hard drive when the hard drive indicators turn off.

 **CAUTION:** To prevent data loss, ensure that your operating system supports hot-swap drive installation. See the documentation supplied with your operating system.

 **NOTE:** Hot swappable hard drives are supplied in hot swappable hard drive carriers that fit in the hard drive slots.

### Steps

1. Press the release button to open the hard drive carrier release handle.
2. Slide the hard drive carrier out of the hard drive slot.

 **CAUTION:** To maintain proper system cooling, all empty hard drive slots must have hard drive carrier blanks installed.

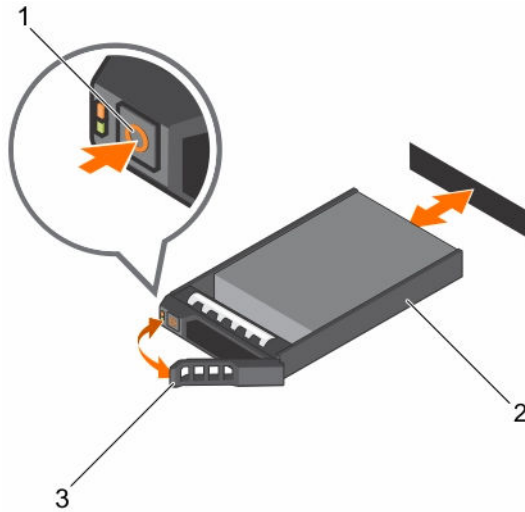

**Figure 20. Removing and installing a hot swappable hard drive carrier**

- |                              |                       |
|------------------------------|-----------------------|
| 1. release button            | 2. hard drive carrier |
| 3. hard drive carrier handle |                       |

#### Next steps

If you are not replacing the hard drive immediately, insert a hard drive carrier blank in the empty hard drive slot, or install a hard drive carrier.

#### Related Links

- [Removing the optional front bezel](#)
- [Installing a 3.5-inch hot swappable hard drive carrier blank](#)
- [Installing a hot swappable hard drive carrier](#)
- [Installing the optional front bezel](#)

## Removing a hot swappable hard drive from a hard drive carrier

#### Prerequisites

**CAUTION:** Many repairs may only be done by a certified service technician. You should only perform troubleshooting and simple repairs as authorized in your product documentation, or as directed by the online or telephone service and support team. Damage due to servicing that is not authorized by Dell is not covered by your warranty. Read and follow the safety instructions that are shipped with your product.

**NOTE:** Hot swappable hard drives are supplied in hot swappable hard drive carriers that fit in the hard drive slots.

1. Keep the Phillips #2 screwdriver ready.
2. Remove the hard drive carrier from the system.

#### Steps

1. Remove the screws from the side rails on the hard drive carrier.
2. Lift the hard drive out of the hard drive carrier.

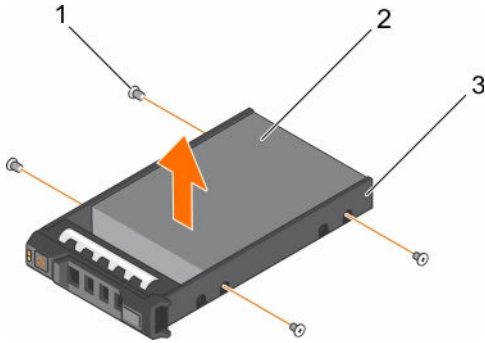

**Figure 21. Removing and installing a hot swappable hard drive into a hard drive carrier**

- |                       |               |
|-----------------------|---------------|
| 1. screw (4)          | 2. hard drive |
| 3. hard drive carrier |               |

#### Next steps

1. Install the hot swappable hard drive into the hard drive carrier.
2. Install the hot swappable hard drive carrier into the system.

#### Related Links

- [Removing a hot swappable hard drive carrier](#)
- [Installing a hot swappable hard drive into a hot swappable hard drive carrier](#)
- [Installing a hot swappable hard drive carrier](#)

## Installing a hot swappable hard drive into a hot swappable hard drive carrier

#### Prerequisites

**⚠ CAUTION:** Many repairs may only be done by a certified service technician. You should only perform troubleshooting and simple repairs as authorized in your product documentation, or as directed by the online or telephone service and support team. Damage due to servicing that is not authorized by Dell is not covered by your warranty. Read and follow the safety instructions that are shipped with your product.

**🔧 NOTE:** Hot swappable hard drives are supplied in hot swappable hard drive carriers that fit in the hard drive slots.

1. Keep the Phillips #2 screwdriver ready.
2. Remove the hot swappable hard drive carrier.

#### Steps

1. Insert the hot swappable hard drive into the hard drive carrier with the connector end of the hard drive toward the back.
2. Align the screw holes on the hard drive with the set of screw holes on the hard drive carrier. When aligned correctly, the back of the hard drive is flush with the back of the hard drive carrier.
3. Attach the screws to secure the hard drive to the hard drive carrier.

#### Next steps







Install the hard drive carrier into the system.

#### Related Links

- [Installing a hot swappable hard drive carrier](#)

## Installing a hot swappable hard drive carrier

### Prerequisites

-  **CAUTION:** Many repairs may only be done by a certified service technician. You should only perform troubleshooting and simple repairs as authorized in your product documentation, or as directed by the online or telephone service and support team. Damage due to servicing that is not authorized by Dell is not covered by your warranty. Read and follow the safety instructions that are shipped with your product.
-  **CAUTION:** Use only hard drives that have been tested and approved for use with the hard drive backplane.
-  **CAUTION:** Combining SAS and SATA hard drives in the same RAID volume is not supported.
-  **CAUTION:** When installing a hard drive, ensure that the adjacent drives are fully installed. Inserting a hard drive carrier and attempting to lock its handle next to a partially installed carrier can damage the partially installed carrier's shield spring and make it unusable.
-  **CAUTION:** To prevent data loss, ensure that your operating system supports hot-swap drive installation. See the documentation supplied with your operating system.
-  **CAUTION:** When a replacement hot swappable hard drive is installed and the system is powered on, the hard drive automatically begins to rebuild. Make absolutely sure that the replacement hard drive is blank or contains data that you wish to have over-written. Any data on the replacement hard drive is immediately lost after the hard drive is installed.
-  **NOTE:** Hot swappable hard drives are supplied in hot swappable hard drive carriers that fit in the hard drive slots.

1. If installed, remove the hard drive carrier blank.
2. Install a hot swappable hard drive into the hot swappable hard drive carrier.

### Steps

1. Press the release button on the front of the hot swappable hard drive carrier and open the hot swappable hard drive carrier handle.
2. Insert the hot swappable hard drive carrier into the hard drive slot, and push the hot swappable hard drive carrier until it comes in contact with the backplane.
3. Close the hot swappable hard drive carrier handle to lock the hot swappable hard drive carrier in place.

### Next steps

If removed, install the front bezel.

### Related Links

[Installing a hot swappable hard drive into a hot swappable hard drive carrier](#)

[Installing the optional front bezel](#)

## Installing a 2.5-inch hot swappable hard drive into a 3.5-inch hard drive adapter

### Prerequisites

**△ CAUTION:** Many repairs may only be done by a certified service technician. You should only perform troubleshooting and simple repairs as authorized in your product documentation, or as directed by the online or telephone service and support team. Damage due to servicing that is not authorized by Dell is not covered by your warranty. Read and follow the safety instructions that are shipped with your product.

1. Ensure that you follow the [Safety instructions](#).
2. Keep the Phillips #2 screwdriver ready.

### Steps

1. Align the screw holes on the 2.5-inch hot swappable hard drive with the screw holes on the 3.5-inch hard drive adapter.
2. Install the screws to secure the 2.5-inch hot swappable hard drive to the 3.5-inch hard drive adapter.

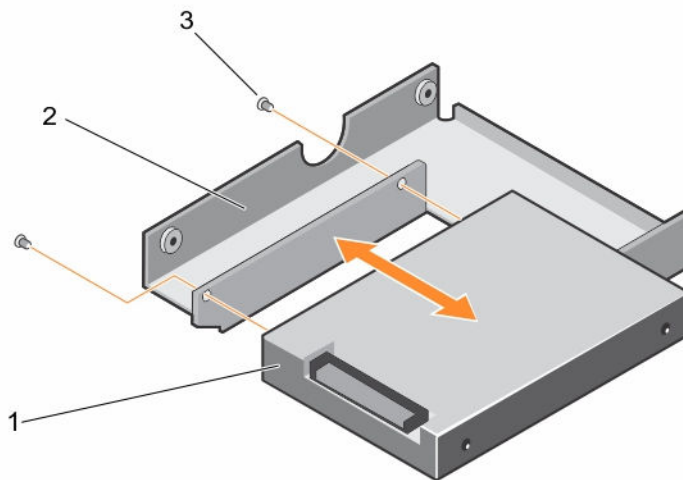

**Figure 22. Removing and installing a 2.5-inch hot swappable hard drive into a 3.5-inch hard drive adapter**

- |                                      |                                |
|--------------------------------------|--------------------------------|
| 1. 2.5-inch hot swappable hard drive | 2. 3.5-inch hard drive adapter |
| 3. screw (2)                         |                                |

### Next steps

Install the 3.5-inch adapter into the 3.5-inch hot swappable hard drive carrier.

### Related Links

[Installing a 3.5-inch hard drive adapter into the 3.5-inch hot swappable hard drive carrier](#)

## Installing a 3.5-inch hard drive adapter into the 3.5-inch hot swappable hard drive carrier

### Prerequisites

**△ CAUTION:** Many repairs may only be done by a certified service technician. You should only perform troubleshooting and simple repairs as authorized in your product documentation, or as directed by the online or telephone service and support team. Damage due to servicing that is not authorized by Dell is not covered by your warranty. Read and follow the safety instructions that are shipped with your product.

1. Ensure that you follow the [Safety instructions](#).
2. Keep the Phillips #2 screwdriver ready.
3. Install the 2.5-inch hot swappable hard drive into the 3.5-inch hard drive adapter.

### Steps

1. Insert the 3.5-inch hard drive adapter into the 3.5-inch hot swappable hard drive carrier with the connector end of the hard drive toward the back of the 3.5-inch hot swappable hard drive carrier.
2. Align the screw holes on the 3.5-inch hard drive adapter and the 3.5-inch hot swappable hard drive carrier.
3. Install the screws to secure the 3.5-inch hard drive adapter to the 3.5-inch hot swappable hard drive carrier.

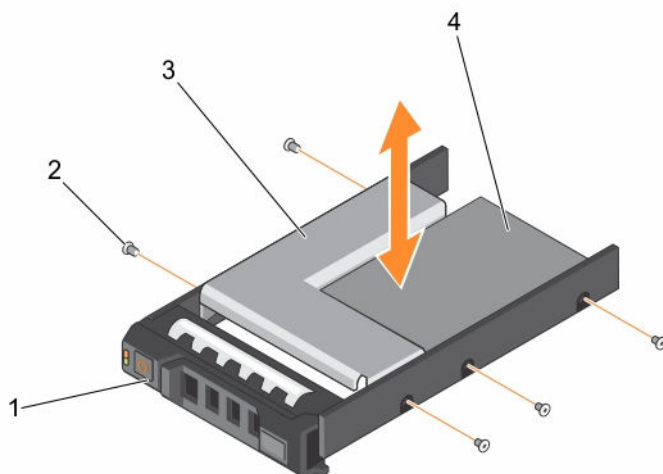

**Figure 23. Removing and installing a 3.5-inch hard drive adapter into a 3.5-inch hot swappable hard drive carrier**

- |  |                                      |
|--|--------------------------------------|
| 1. 3.5-inch hot swappable hard drive carrier | 2. screw (5)                         |
| 3. 3.5-inch hard drive adapter               | 4. 2.5-inch hot swappable hard drive |

### Next steps

Install the 3.5-inch hot swappable hard drive carrier into the system.

### Related Links

- [Installing a 2.5-inch hot swappable hard drive into a 3.5-inch hard drive adapter](#)
- [Installing a hot swappable hard drive carrier](#)



## Removing a 3.5-inch hard drive adapter from a 3.5-inch hot swappable hard drive carrier

### Prerequisites

1. Ensure that you follow the [Safety instructions](#).
2. Keep the Phillips #2 screwdriver ready.
3. Remove the 3.5-inch hot swappable hard drive carrier from the system.

### Steps

1. Remove the screws from the rails on the 3.5-inch hot swappable hard drive carrier.
2. Lift the 3.5-inch hard drive adapter out of the 3.5-inch hot swappable hard drive carrier.

### Next steps

Remove the 2.5-inch hot swappable hard drive from a 3.5-inch hard drive adapter.

### Related Links

[Removing a hot swappable hard drive carrier](#)

## Removing a 2.5-inch hot swappable hard drive from a 3.5-inch hard drive adapter

### Prerequisites



**CAUTION:** Many repairs may only be done by a certified service technician. You should only perform troubleshooting and simple repairs as authorized in your product documentation, or as directed by the online or telephone service and support team. Damage due to servicing that is not authorized by Dell is not covered by your warranty. Read and follow the safety instructions that came with the product.

1. Ensure that you follow the [Safety instructions](#).
2. Keep the Phillips #2 screwdriver ready.
3. Remove the 3.5-inch hard drive adapter from the 3.5-inch hot swappable hard drive carrier.



**NOTE:** A 2.5-inch hot swappable hard drive is installed in a 3.5-inch hard drive adapter, which is then installed in the 3.5-inch hot swappable hard drive carrier.

### Steps

1. Remove the screws from the side of the 3.5-inch hard drive adapter.
2. Remove the 2.5-inch hot swappable hard drive from the 3.5-inch hard drive adapter.

### Related Links

[Removing a 3.5-inch hard drive adapter from a 3.5-inch hot swappable hard drive carrier](#)

## Hard drive backplane

Your system supports an x8 SAS/SATA backplane for 3.5-inch hard drives.



**NOTE:** The x8 backplane also supports up to eight 2.5-inch (SAS, SATA, or SSD) hot swappable hard drives installed in 3.5-inch hard drive adapters, which are then installed in the 3.5-inch hard drive carriers.

 **NOTE:** Only systems with hot swappable hard drives support hard drive backplanes.

## Removing the hard drive backplane

### Prerequisites

 **CAUTION:** Many repairs may only be done by a certified service technician. You should only perform troubleshooting and simple repairs as authorized in your product documentation, or as directed by the online or telephone service and support team. Damage due to servicing that is not authorized by Dell is not covered by your warranty. Read and follow the safety instructions that are shipped with your product.

1. Ensure that you follow the [Safety instructions](#).
2. Follow the procedure listed in [Before working inside your system](#).

 **CAUTION:** To prevent damage to the drives and backplane, remove the hard drives from the system before removing the backplane.

 **CAUTION:** Note the slot number of each hard drive and temporarily label the slots before removing the hard drives so that you can replace them in the same locations.

3. Remove all hard drives.

### Steps

1. Disconnect the SAS, power, and data cables from the hard drive backplane.
2. Pull the release pin, and lift the backplane out of the system.

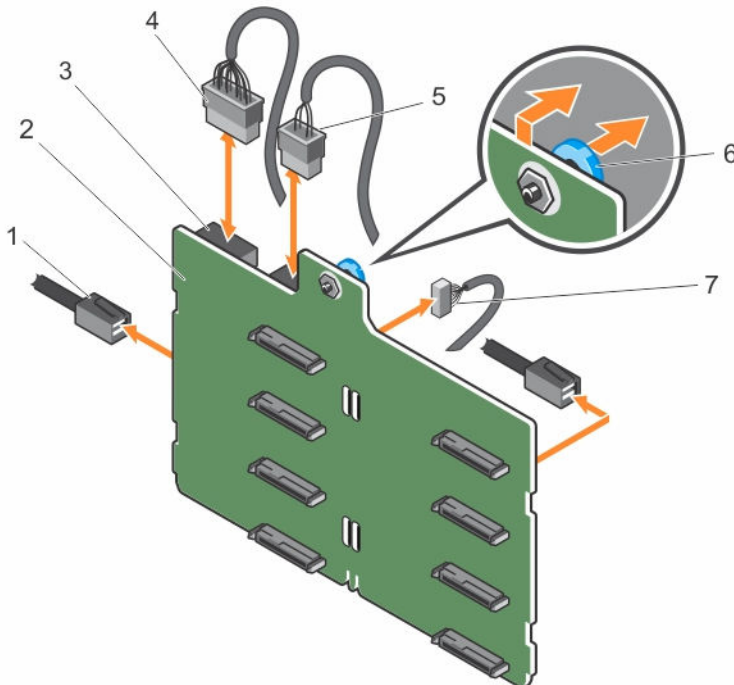
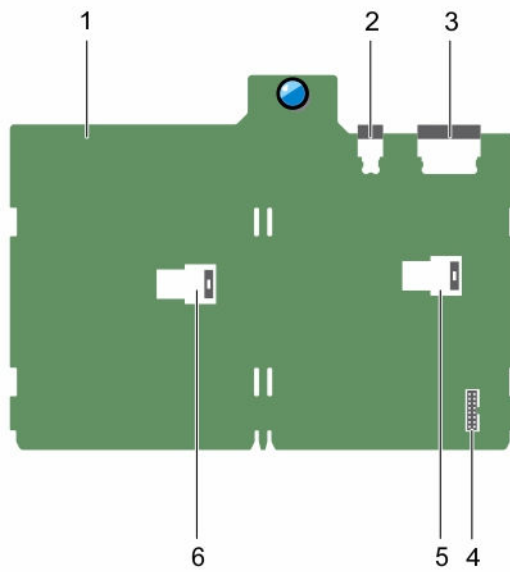

**Figure 24. Removing and installing an x8 hard drive backplane**

- |                    |                          |
|--------------------|--------------------------|
| 1. SAS cable       | 5. data cable            |
| 3. power connector | 6. release pin           |
|                    | 7. another cable         |
|                    | 4. backplane power cable |

- 5. optical disk drive power cable
- 7. signal cable

- 6. release pin



**Figure 25. Connectors on an x8 hard drive backplane**

- 1. x8 hard drive backplane
- 3. backplane power connector
- 5. SAS A connector

- 2. optical disk drive connector
- 4. backplane signal connector
- 6. SAS B connector

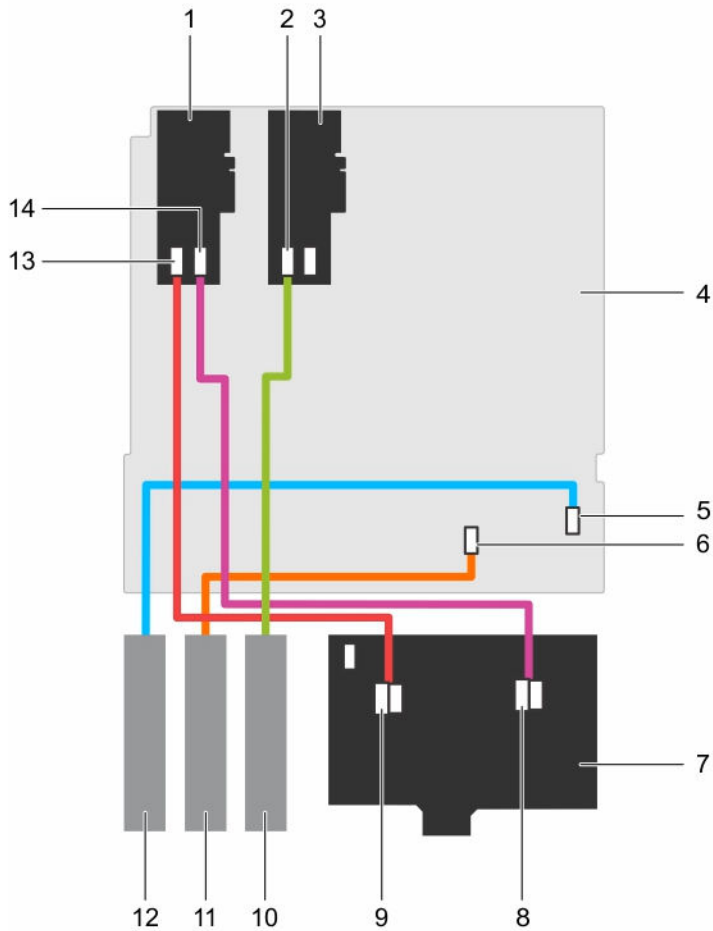

**Figure 26. Cabling—x8 hard drive backplane with PERC card and SAS HBA**

- |   |  |
|---|--|
| 1. PERC card                                    | 2. SAS tape drive connector on SAS HBA |
| 3. SAS Host Bus Adapter (HBA)                   | 4. system board                        |
| 5. optical disk drive connector on system board | 6. SATA connector on system board      |
| 7. x8 hard drive backplane                      | 8. SAS B connector on backplane        |
| 9. SAS A connector on backplane                 | 10. SAS tape drive                     |
| 11. optical disk drive or SATA tape drive       | 12. optical disk drive                 |
| 13. SAS A connector on PERC card                | 14. SAS B connector on PERC card       |

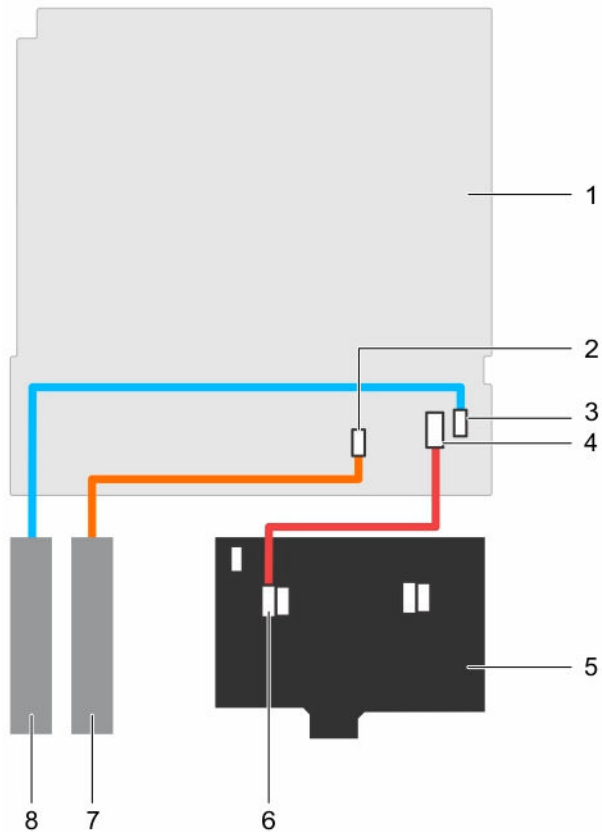

**Figure 27. Cabling—x4 hard drive backplane**

- |   |                                   |
|---|-----------------------------------|
| 1. system board                                 | 2. SATA connector on system board |
| 3. optical disk drive connector on system board | 4. mini SAS connector             |
| 5. x4 hard drive backplane                      | 6. SAS A connector on backplane   |
| 7. optical disk drive or SATA tape drive        | 8. optical disk drive             |

**Next steps**

1. Install the hard drive backplane.
2. Follow the procedure listed in [After working inside your system.](#)

**Related Links**

- [Removing a hot swappable hard drive carrier](#)
- [Installing the hard drive backplane](#)

## Installing the hard drive backplane

### Prerequisites

 **CAUTION:** Many repairs may only be done by a certified service technician. You should only perform troubleshooting and simple repairs as authorized in your product documentation, or as directed by the online or telephone service and support team. Damage due to servicing that is not authorized by Dell is not covered by your warranty. Read and follow the safety instructions that are shipped with your product.

1. Ensure that you follow the [Safety instructions](#).
2. Follow the procedure listed in [Before working inside your system](#).

### Steps

1. Align the hooks at the back of the hard drive bay with the slots on the backplane.
2. Slide down the hard drive backplane until the release pin locks into the slot.
3. Connect the SAS, power, and data cables to the hard drive backplane.

### Next steps

1. Install the hard drives in their original locations.
2. Follow the procedure listed in [After working inside your system](#).

### Related Links

[Installing a hot swappable hard drive carrier](#)

## Four-slot hard drive blank

Systems with x8 hard drive backplanes configured for software RAID support only four hard drives. The remaining hard drive slots are pre-installed with the four-slot hard drive blank, and cannot be upgraded for additional storage.

## Removing a four-slot hard drive blank

### Prerequisites

 **CAUTION:** To maintain proper system cooling, all empty hard drive slots must have hard drive blanks installed.

1. Ensure that you follow the [Safety instructions](#).
2. Follow the procedure listed in [Before working inside your system](#).

 **CAUTION:** To prevent damage to the hard drives and backplane, you must remove the hard drives from the system before removing the backplane.

 **CAUTION:** Note the slot number of each hard drive and temporarily label the slots before removing the hard drives so that you can replace them in the same location(s).

3. Remove the cooling shroud.
4. Remove all hard drives.
5. Remove the x8 hard drive backplane.

### Steps

1. Using a screwdriver, push the release tabs on the corners of the blank from inside the system, to unlock the four-slot hard drive blank from the chassis.
2. From the front of the system, pull the four-slot hard drive blank at the corners until it is free of the hard drive slot.

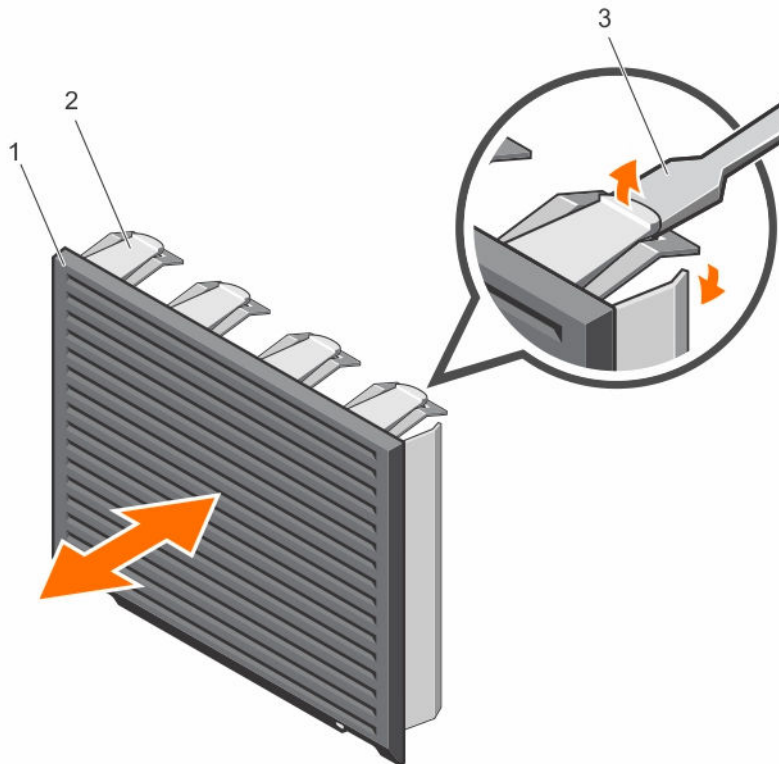

**Figure 28. Installing and removing the four-slot hard drive blank**

1. four-slot hard drive blank
2. release tab (4)
3. screwdriver

### Next steps

1. Install the four-slot hard drive blank.
2. Follow the procedure listed in [After working inside your system](#).

### Related Links

- [Removing the cooling shroud](#)
- [Removing a hot swappable hard drive from a hard drive carrier](#)
- [Removing the hard drive backplane](#)
- [Installing a four-slot hard drive blank](#)

## Installing a four-slot hard drive blank

### Prerequisites

1. Ensure that you follow the [Safety instructions](#).
2. Follow the procedure listed in [Before working inside your system](#).

### Steps

1. Locate the hard drive slots numbered from four to seven.
2. Insert the four-slot hard drive blank into the hard drive slot, and push it until the release tabs click into place.

### Next steps

1. Install the x8 hard drive backplane.
2. Install all hard drives.
3. Install the cooling shroud.
4. Follow the instructions listed in [After working inside your system](#).

### Related Links

[Installing a hot swappable hard drive carrier](#)

[Installing the hard drive backplane](#)

[Installing the cooling shroud](#)

## System memory

Your system supports DDR4 ECC unbuffered DIMMs (RDIMMs).

 **NOTE:** MT/s indicates memory module speed in Mega Transfers per second.

Memory bus operating frequency can be 2133 MT/s, 1866 MT/s, or 1600 MT/s depending on the following factors:

- System profile selected (for example, Performance Optimized, Custom, or Dense Configuration Optimized)
- Maximum supported memory module frequency of the processors

The system contains four memory sockets — two sets of 2-sockets each. Each 2-socket set is organized into one channel. In each 2-socket set, the first socket release lever is marked white and the second socket release lever is marked black.



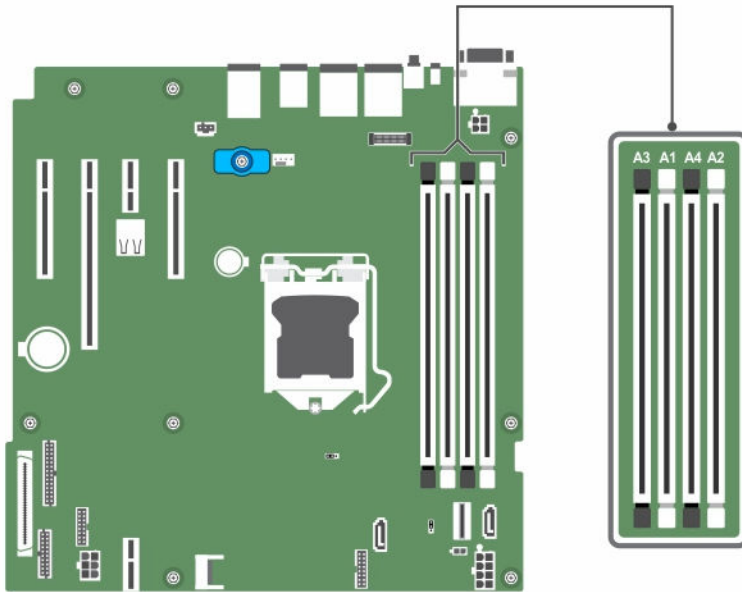

**Figure 29. Memory socket locations on the system board**

Memory channels are organized as follows:

- Processor 1**
- channel 0: memory sockets A1 and A3
  - channel 1: memory sockets A2 and A4

The following table shows the memory populations and operating frequencies for the supported configurations:

**Table 12. Memory populations and operating frequencies for the supported configurations**

Memory module type	Memory modules populated per channel	Operating frequency (in MT/s)	Maximum memory module ranks per channel
<b>1.2 V</b>			
ECC (RDIMM)	1	2133, 1866, 1600	Dual rank or single rank
	2	2133, 1866, 1600	Dual rank or single rank

### General memory module installation guidelines

Your system supports Flexible Memory Configuration, enabling the system to be configured and run in any valid chipset architectural configuration. The following are the recommended guidelines for installing memory modules:

- x4 and x8 DRAM-based DIMMs can be mixed.
- Up to two dual- or single-rank ECC UDIMMs can be populated per channel.
- Populate DIMM sockets only if a processor is installed. For single-processor systems, sockets A1 to A4 are available.

- Populate all sockets with white release levers first, and then all the sockets with black release levers.
- When mixing memory modules with different capacities, populate the sockets with memory modules with the highest capacity first. For example, if you want to mix 4 GB and 8 GB DIMMs, populate 8 GB DIMMs in the sockets with white release levers and 4 GB DIMMs in the sockets with black release levers.
- Memory modules of different capacities can be mixed provided other memory population rules are followed (for example, 4 GB and 8 GB memory modules can be mixed).
- Mixing of more than two DIMM capacities in a system is not supported.
- Populate two DIMMs per processor (one DIMM per channel) at a time to maximize performance.

## Sample memory configurations

The following table shows sample memory configurations for a single processor configuration.

 **NOTE:** 1R and 2R in the following table indicate single and dual-rank memory modules respectively.

**Table 13. Memory configurations—single processor**

Populated system capacity (in GB)	Memory module size (in GB)	Number of memory modules	Memory module rank, organization, and frequency	memory module slot population
4	4	1	1R, x8, 2133 MT/s, 1R, x8, 1866 MT/s	A1
8	4	2	1R, x8, 2133 MT/s, 1R, x8, 1866 MT/s	A1, A2
16	4	4	1R, x8, 2133 MT/s, 1R, x8, 1866 MT/s	A1, A2, A3, A4
	8	2	2R, x8, 2133 MT/s, 2R, x8, 1866 MT/s	A1, A2
32	8	4	2R, x8, 2133 MT/s, 2R, x8, 1866 MT/s	A1, A2, A3, A4
	16	2	2R, x8, 2133 MT/s, 2R, x8, 1866 MT/s	A1, A2
64	16	4	2R, x8, 2133 MT/s, 2R, x8, 1866 MT/s	A1, A2, A3, A4

## Removing memory modules

### Prerequisites

**CAUTION:** Many repairs may only be done by a certified service technician. You should only perform troubleshooting and simple repairs as authorized in your product documentation, or as directed by the online or telephone service and support team. Damage due to servicing that is not authorized by Dell is not covered by your warranty. Read and follow the safety instructions that are shipped with your product.

1. Ensure that you follow the [Safety instructions](#).
2. Follow the procedure listed in [Before working inside your system](#).
3. Remove the cooling shroud.

**WARNING:** The memory modules are hot to touch for some time after the system has been powered down. Allow the memory modules to cool before handling them. Handle the memory modules by the card edges and avoid touching the components or metallic contacts on the memory module.

**CAUTION:** To ensure proper system cooling, memory module blanks must be installed in any memory socket that is not occupied. Remove memory module blanks only if you intend to install memory modules in those sockets.

### Steps

1. Locate the appropriate memory module socket.

**CAUTION:** Handle each memory module only by the card edges, ensuring not to touch the middle of the memory module or metallic contacts.

2. To release the memory module from the socket, simultaneously press the ejectors on both ends of the memory module socket.
3. Lift the memory module away from the system.

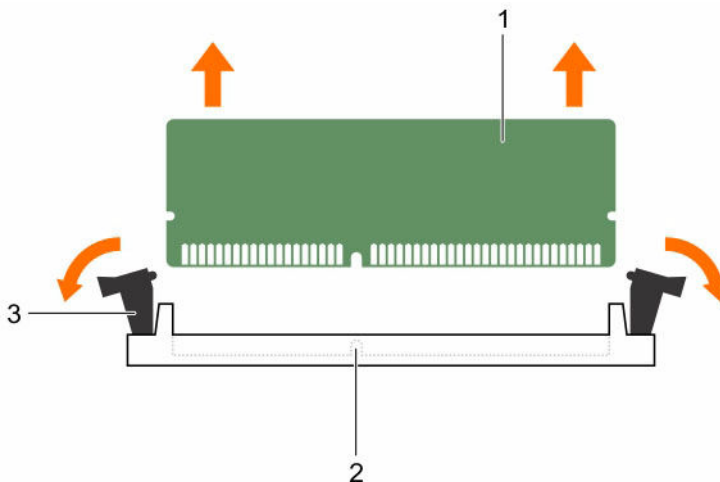

Figure 30. Removing and installing a memory module

1. memory module
2. memory module socket
3. memory module socket ejector (2)

## Next steps

1. Install the memory module.
2. Install the cooling shroud.
3. Follow the procedure listed in [After working inside your system](#).

## Related Links

[Removing the cooling shroud](#)

[Installing memory modules](#)

[Installing the cooling shroud](#)

## Installing memory modules

### Prerequisites

 **CAUTION:** Many repairs may only be done by a certified service technician. You should only perform troubleshooting and simple repairs as authorized in your product documentation, or as directed by the online or telephone service and support team. Damage due to servicing that is not authorized by Dell is not covered by your warranty. Read and follow the safety instructions that are shipped with your product.

1. Ensure that you follow the [Safety instructions](#).
2. Follow the procedure listed in [Before working inside your system](#).
3. Remove the cooling shroud.

 **WARNING:** The memory modules are hot to touch for some time after the system has been powered down. Allow the memory modules to cool before handling them. Handle the memory modules by the card edges and avoid touching the components or metallic contacts on the memory module.

### Steps

1. Locate the appropriate memory module socket.

 **CAUTION:** Handle each memory module only by the card edges, ensuring not to touch the middle of the memory module or metallic contacts.

 **CAUTION:** To prevent damage to the memory module or the memory module socket during installation, do not bend or flex the memory module; insert both ends of the memory module simultaneously.

2. Align the edge connector of the memory module with the alignment key of the memory module socket, and insert the memory module in the socket.

 **NOTE:** The alignment key allows you to install the memory module in the socket in only one orientation.

 **CAUTION:** Do not apply pressure at the center of the memory module; apply pressure at both ends of the memory module evenly.

3. Press the memory module with your thumbs until the socket levers firmly click into place.

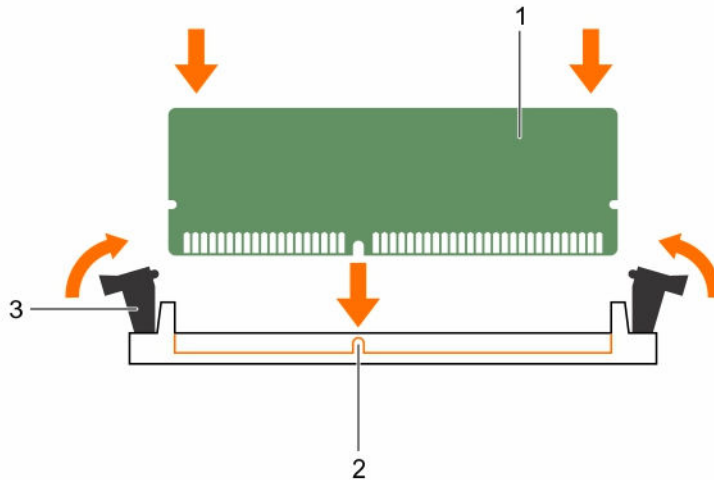

**Figure 31. Installing the memory module**

1. memory module
2. alignment key
3. memory module socket ejector (2)

#### Next steps

1. Install the cooling shroud.
2. Follow the procedure listed in [After working inside your system](#).
3. Press F2 to enter System Setup, and check the **System Memory** setting. The **System Memory Size** should reflect the installed memory.
4. If the value is incorrect, one or more of the memory modules may not be installed properly. Ensure that the memory modules are firmly seated in the sockets.
5. Run the system memory test in system diagnostics. See [Dell Embedded System Diagnostics](#).

#### Related Links

- [Removing the cooling shroud](#)
- [Installing the cooling shroud](#)

## Cooling fans

The system supports an internal cooling fan.

-  **NOTE:** When selecting or upgrading your system configuration, verify the system power consumption with the Dell Energy Smart Solution Advisor at [Dell.com/ESSA](https://www.dell.com/ESSA) to ensure optimum power utilization.

## Removing the internal cooling fan

### Prerequisites

 **CAUTION:** Many repairs may only be done by a certified service technician. You should only perform troubleshooting and simple repairs as authorized in your product documentation, or as directed by the online or telephone service and support team. Damage due to servicing that is not authorized by Dell is not covered by your warranty. Read and follow the safety instructions that are shipped with your product.

 **CAUTION:** Never operate your system with the internal cooling fan removed. The system can overheat and result in shutdown of the system and loss of data.

 **CAUTION:** Do not operate the system with the cover removed for a duration exceeding 5 minutes.

1. Ensure that you follow the [Safety instructions](#).
2. Follow the procedure listed in [Before working inside your system](#).
3. Remove the cooling shroud.

### Steps

1. Disconnect the internal cooling fan power cable from the system board.
2. Holding the internal cooling fan, press the release tab, and slide the cooling fan out in the direction of the arrow marked on the fan.

 **CAUTION:** Do not remove or install the internal cooling fan by holding the fan blades.

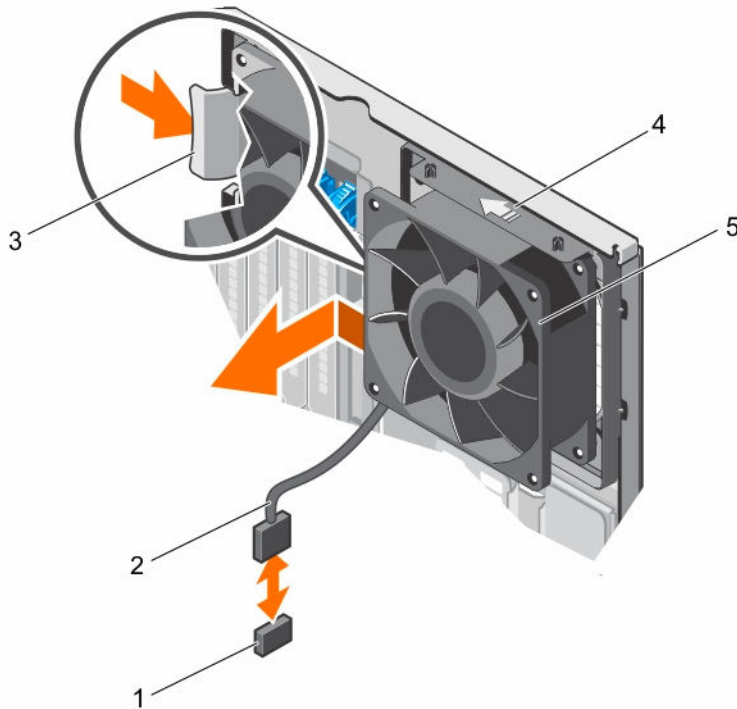

**Figure 32. Removing and installing the internal cooling fan**

1. fan connector on the system board
2. internal cooling fan power cable
3. release tab
4. arrow
5. internal cooling fan

#### Next steps

1. Install the internal cooling fan.
2. Follow the procedure listed in [After working inside your system](#).

#### Related Links

- [Removing the cooling shroud](#)
- [Installing the internal cooling fan](#)
- [Installing the cooling shroud](#)

## Installing the internal cooling fan

#### Prerequisites

**⚠ CAUTION:** Many repairs may only be done by a certified service technician. You should only perform troubleshooting and simple repairs as authorized in your product documentation, or as directed by the online or telephone service and support team. Damage due to servicing that is not authorized by Dell is not covered by your warranty. Read and follow the safety instructions that are shipped with your product.

**⚠ CAUTION:** Do not operate the system with the cover removed for a duration exceeding 5 minutes.

1. Ensure that you follow the [Safety instructions](#).

2. Follow the procedure listed in [Before working inside your system](#).
3. Remove the cooling shroud.

#### Steps

1. Hold the cooling fan by the sides with the cable end facing the bottom of the chassis.

 **CAUTION: Do not remove or install the internal cooling fan by holding the fan blades.**

2. Align the four tabs on the internal cooling fan with the four slots on the chassis wall.
3. Press and slide the internal cooling fan into the slots until the release tab locks into place.
4. Connect the internal cooling fan power cable to the FAN6 connector on the system board.

#### Next steps

1. Install the cooling shroud.
2. Follow the procedure listed in [After working inside your system](#).

#### Related Links

[Removing the cooling shroud](#)

[Installing the cooling shroud](#)

## Internal USB memory key (optional)

A USB memory key installed inside your system can be used as a boot device, security key, or mass storage device. The USB connector must be enabled by the **Internal USB Port** option in the **Integrated Devices** screen of System Setup.

To boot from the USB memory key, configure the USB memory key with a boot image and then specify the USB memory key in the boot sequence in System Setup.

 **NOTE:** To locate the internal USB connector (INT\_USB) on the system board, see [System board jumpers and connectors](#).

## Replacing the optional internal USB memory key

#### Prerequisites

 **CAUTION: Many repairs may only be done by a certified service technician. You should only perform troubleshooting and simple repairs as authorized in your product documentation, or as directed by the online or telephone service and support team. Damage due to servicing that is not authorized by Dell is not covered by your warranty. Read and follow the safety instructions that are shipped with your product.**

1. Ensure that you follow the [Safety instructions](#).
2. Follow the procedure listed in [Before working inside your system](#).

#### Steps

1. Locate the USB connector or USB memory key on the system board.

 **NOTE:** To locate the internal USB connector on the system board, see [System board jumpers and connectors](#).

2. If installed, remove the USB memory key from the USB connector.
3. Insert the replacement USB memory key into the USB connector.



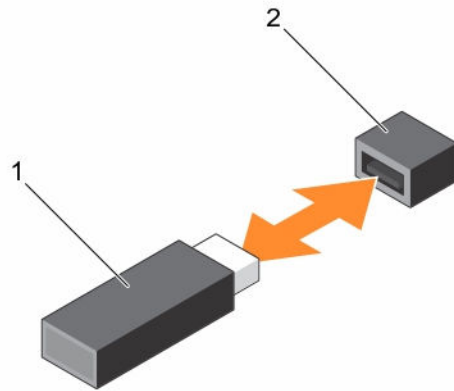

**Figure 33. Replacing the internal USB memory key**

1. USB memory key
2. USB memory key connector

#### Next steps

1. Follow the procedure listed in [After working inside your system](#).
2. While booting, press F2 to enter System Setup and verify that the USB memory key is detected by the system.

## Expansion cards

### Expansion card installation guidelines

Your system supports Generation 3 cards. The following table lists the supported expansion cards:

**Table 14. PCI Express Generation 3 expansion cards supported**

PCIe Slot	Processor Connection	Height	Length	Link Width	Slot Width
1	Processor	Full Height	Half Length	x4	x8
2	Processor	Full Height	Half Length	x8	x16
3	Platform Controller Hub	Full Height	Half Length	x1	x1
4	Platform Controller Hub	Full Height	Half Length	x4	x8

 **NOTE:** All slots support Generation 3 PCIe expansion cards.

 **NOTE:** The expansion cards are not hot swappable.

The following table provides a guide for installing expansion cards to ensure proper cooling and mechanical fit. Install the expansion card by following the card priority and slot priority order as shown in the table.

**Table 15. Expansion card installation order**

Card Priority	Card Type	Form factor	Slot Priority	Maximum Allowed
1	PowerEdge RAID Controller (PERC) H730	Full Height	2, 1, 4	1
	PERC H330	Full Height	2, 1, 4	1
	PERC H830	Full Height	2, 1, 4	2
2	10 G NICs Dual Port (Intel)	Full Height	2, 1, 4	3
	10 G NICs Dual Port (Broadcom)	Full Height	2, 1, 4	3
3	Fibre Channel 8 Gb Host Bus Adapter (HBA) (Qlogic)	Full Height	2, 1, 4	3
	Fibre Channel 8 Gb HBA (Emulex)	Full Height	2, 1, 4	3
	Fibre Channel 8 Gb HBA (Blackhawk-2)	Full Height	2, 1, 4	3
	Fibre Channel 8 Gb HBA (Wildfire-2)	Full Height	2, 1, 4	3
4	1 Gb NICs Quad Port (Intel)	Full Height	1, 2, 4	3
	1 G NICs Quad Port (Broadcom)	Full Height	1, 2, 4	3
	1 Gb NICs Dual Port (Intel)	Full Height	1, 2, 4	3
	1 G NICs Dual Port (Broadcom)	Full Height	3, 1, 4, 2	3
5	12 Gb SAS HBA	Full Height	2, 1, 4	3

## Removing an expansion card

### Prerequisites

 **CAUTION:** Many repairs may only be done by a certified service technician. You should only perform troubleshooting and simple repairs as authorized in your product documentation, or as directed by the online or telephone service and support team. Damage due to servicing that is not authorized by Dell is not covered by your warranty. Read and follow the safety instructions that are shipped with your product.

1. Ensure that you follow the [Safety instructions](#).
2. Follow the procedure listed in [Before working inside your system](#).
3. Remove the cooling shroud.
4. Disconnect the cables from the expansion card.

### Steps

1. Open the expansion card latch by pulling the latch up.
2. Hold the expansion card by its edges, and pull the card until the card edge connector disengages from the expansion card connector.
3. Install the filler bracket by performing the following steps:
  - a. Align the tab on the filler bracket with the expansion card slot.
  - b. Press the expansion card latch until the filler bracket locks into place.

 **NOTE:** Filler brackets must be installed over empty expansion card slots to maintain FCC certification of the system. The brackets also keep dust and dirt out of the system and aid in proper cooling and airflow inside the system.

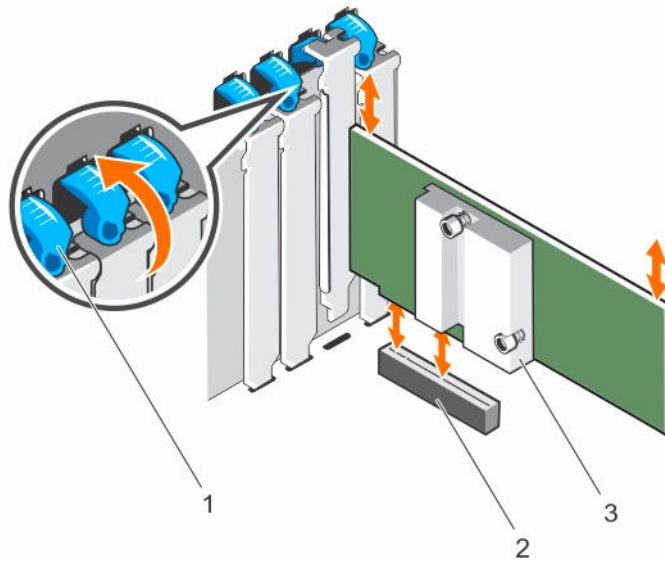

**Figure 34. Removing and installing an expansion card**

1. expansion card latch
2. expansion card connector
3. expansion card

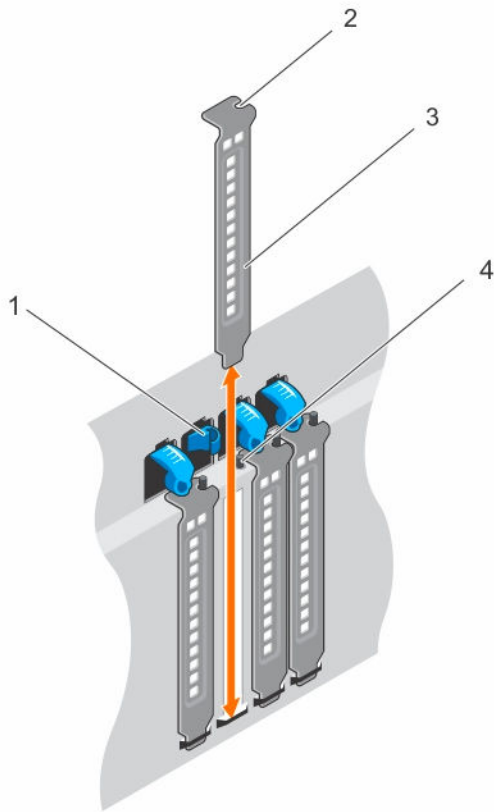

**Figure 35. Removing and installing the filler bracket**

- |                         |              |
|-------------------------|--------------|
| 1. expansion card latch | 2. slot      |
| 3. filler bracket       | 4. guide pin |

#### Next steps

1. Install an expansion card.
2. Follow the procedure listed in [After working inside your system](#).

#### Related Links

- [Removing the cooling shroud](#)
- [Installing an expansion card](#)

## Installing an expansion card

#### Prerequisites

**⚠ CAUTION:** Many repairs may only be done by a certified service technician. You should only perform troubleshooting and simple repairs as authorized in your product documentation, or as directed by the online or telephone service and support team. Damage due to servicing that is not authorized by Dell is not covered by your warranty. Read and follow the safety instructions that are shipped with your product.

1. Ensure that you follow the [Safety instructions](#).
2. Follow the procedure listed in [Before working inside your system](#).

3. Remove the cooling shroud.
4. Disconnect the cables from the expansion card.

### Steps

1. Unpack the expansion card and prepare it for installation.  
For instructions, see the documentation accompanying the card.
2. Open the expansion card latch for the slot in which you want to install the expansion card.
3. If you are installing a new card, slide the filler bracket out of the system.
  -  **NOTE:** Store the filler bracket for future use. Filler brackets must be installed in empty expansion card slots to maintain FCC certification of the system. The brackets also keep dust and dirt out of the system and aid in proper cooling and airflow inside the system.
4. Hold the card by its edges, and align the card edge connector with the expansion card connector.
5. Insert the card edge connector into the expansion card connector until the card is fully seated.
6. Close the expansion card latch by pushing the latch down until the latch snaps into place.

### Next steps

1. Reconnect all the cables to the expansion card.
2. Install the cooling shroud.
3. Follow the procedure listed in [After working inside your system](#).

### Related Links

[Installing the cooling shroud](#)

## iDRAC port card (optional)

The iDRAC ports card consists of a SD vFlash card slot and an iDRAC port. The iDRAC ports card is used for advanced management of the system. An SD vFlash card is a Secure Digital (SD) card that plugs into the SD vFlash card slot in the system. It provides persistent on-demand local storage and a custom deployment environment that allows automation of server configuration, scripts, and imaging. It emulates USB device(s). For more information, see the Integrated Dell Remote Access Controller User's Guide at [dell.com/esmanuals](http://dell.com/esmanuals).

The iDRAC port card consists of the SD vFlash card slot and an iDRAC port. The iDRAC port card features a dedicated NIC port and is used for remote, advanced management of the system through the network. An SD vFlash card is a Secure Digital (SD) card that plugs into the SD vFlash card slot in the iDRAC port card. It provides persistent on-demand local storage and a custom deployment environment that enables automation of server configuration, scripts, and imaging. It emulates a USB device. For more information, see the Integrated Dell Remote Access Controller User's Guide at [Dell.com/idracmanuals](http://Dell.com/idracmanuals).

## Removing the optional iDRAC port card

### Prerequisites

 **CAUTION:** Many repairs may only be done by a certified service technician. You should only perform troubleshooting and simple repairs as authorized in your product documentation, or as directed by the online or telephone service and support team. Damage due to servicing that is not authorized by Dell is not covered by your warranty. Read and follow the safety instructions that are shipped with your product.

1. Ensure that you follow the [Safety instructions](#).
2. Follow the procedure listed in [Before working inside your system](#).

3. Keep the Phillips #2 screwdriver ready.
4. Remove the cooling shroud.
5. Remove the internal cooling fan.
6. Disconnect any cables connected to the iDRAC port card.

#### Steps

1. Loosen the screw that secures the iDRAC port card holder to the system board.
2. Pull the iDRAC port card to disengage it from the iDRAC port card connector on the system board, and remove the card from the chassis.

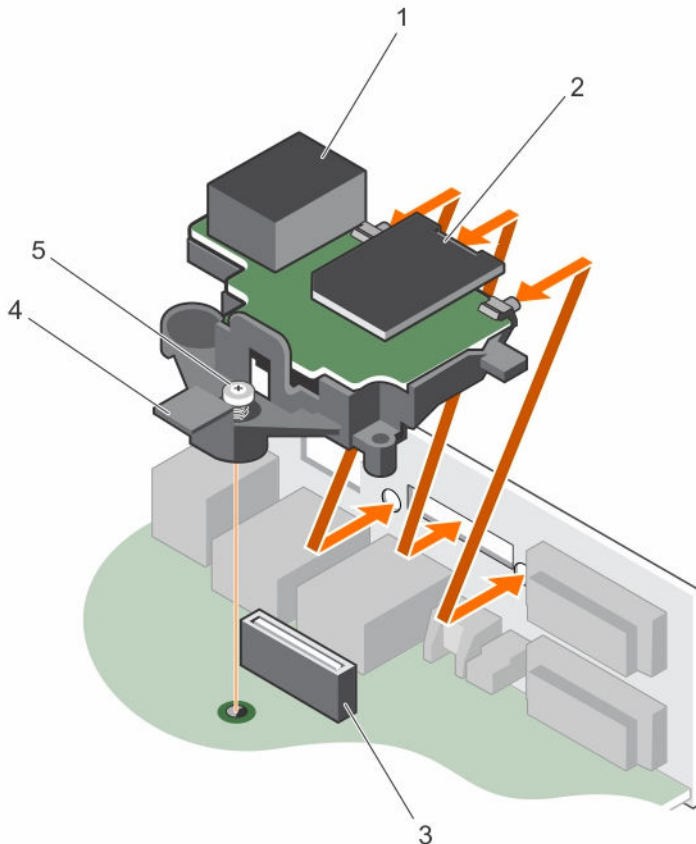

**Figure 36. Removing and installing the iDRAC port card**

- |                              |                           |
|------------------------------|---------------------------|
| 1. iDRAC port                | 2. SD vFlash media card   |
| 3. iDRAC port card connector | 4. iDRAC port card holder |
| 5. screw                     |                           |

#### Next steps

1. Install the iDRAC port card.
2. Follow the procedure listed in [After working inside your system](#).

#### Related Links

[Removing the cooling shroud](#)

[Removing the internal cooling fan](#)

[Installing the optional iDRAC port card](#)

[Installing the internal cooling fan](#)

[Installing the cooling shroud](#)

## Installing the optional iDRAC port card

### Prerequisites

 **CAUTION:** Many repairs may only be done by a certified service technician. You should only perform troubleshooting and simple repairs as authorized in your product documentation, or as directed by the online or telephone service and support team. Damage due to servicing that is not authorized by Dell is not covered by your warranty. Read and follow the safety instructions that are shipped with your product.

1. Ensure that you follow the [Safety instructions](#).
2. Follow the procedure listed in [Before working inside your system](#).
3. Keep the Phillips #2 screwdriver ready.
4. Remove the cooling shroud.
5. Remove the internal cooling fan.

### Steps

1. Align and insert the tabs on the iDRAC port card on the slots on the chassis wall.
2. Insert the iDRAC port card into the connector on the system board.
3. Tighten the screw to secure the iDRAC port card.

### Next steps

1. Reconnect all the cables to the iDRAC port card.
2. Install the internal cooling fan.
3. Install the cooling shroud.
4. Follow the procedure listed in [After working inside your system](#).

### Related Links

[Removing the cooling shroud](#)

[Removing the internal cooling fan](#)

[Installing the internal cooling fan](#)

[Installing the cooling shroud](#)

## Replacing an optional SD vFlash card

1. Locate the SD vFlash card slot at the back of the chassis.
2. To remove the SD vFlash card, push the SD vFlash card inward to release it, and pull the SD vFlash card from the SD vFlash card slot.

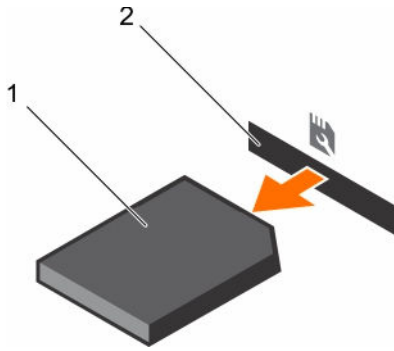

**Figure 37. Removing and installing the SD vFlash card**

1. SD vFlash card
  2. SD vFlash card slot
3. Install a replacement SD vFlash card by inserting the contact-pin end of the SD vFlash card into the SD vFlash card slot on the module.
    -  **NOTE:** The slot is keyed to ensure correct insertion of the SD vFlash card.
  4. Press the SD vFlash card inward to lock it into the SD vFlash card slot.

## Internal dual SD module (optional)

The Internal Dual SD Module (IDSDM) card provides two SD card slots. This card offers the following features:

- Dual card operation — maintains a mirrored configuration by using SD cards in both the slots and provides redundancy.
  -  **NOTE:** When the **Redundancy** option is set to **Mirror Mode** in the **Integrated Devices** screen of System Setup, the information is replicated from one SD card to another.
- Single card operation — single card operation is supported, but without redundancy.

### Removing an optional internal SD card

#### Prerequisites

 **CAUTION:** Many repairs may only be done by a certified service technician. You should only perform troubleshooting and simple repairs as authorized in your product documentation, or as directed by the online or telephone service and support team. Damage due to servicing that is not authorized by Dell is not covered by your warranty. Read and follow the safety instructions that are shipped with your product.

1. Ensure that you follow the [Safety instructions](#).
2. Follow the procedure listed in [Before working inside your system](#).

#### Steps

1. Locate the SD card slot on the internal dual SD module and press the card to release it from the slot.
  -  **NOTE:** Temporarily label each SD card with its corresponding slot number before removal. Reinstall the SD card(s) into the corresponding slots.
2. Lift the SD card away from the internal dual SD module.



## Next steps

1. Install an internal SD card.
2. Follow the procedure listed in [After working inside your system](#).

## Related Links

[Installing an optional internal SD card](#)

# Installing an optional internal SD card

## Prerequisites

 **CAUTION:** Many repairs may only be done by a certified service technician. You should only perform troubleshooting and simple repairs as authorized in your product documentation, or as directed by the online or telephone service and support team. Damage due to servicing that is not authorized by Dell is not covered by your warranty. Read and follow the safety instructions that are shipped with your product.

1. Ensure that you follow the [Safety instructions](#).
2. Follow the procedure listed in [Before working inside your system](#).
3. Ensure that the **Internal SD Card Port** option is set to **Enabled** in System Setup.

## Steps

1. Locate the SD card connector on the internal dual SD module. Orient the SD card appropriately and insert the contact-pin end of the card into the slot.

 **NOTE:** The slot is keyed to ensure correct insertion of the card.

2. Press the card into the card slot to lock it into place.

## Next steps

# Removing the optional internal dual SD module

## Prerequisites

 **CAUTION:** Many repairs may only be done by a certified service technician. You should only perform troubleshooting and simple repairs as authorized in your product documentation, or as directed by the online or telephone service and support team. Damage due to servicing that is not authorized by Dell is not covered by your warranty. Read and follow the safety instructions that are shipped with your product.

1. Ensure that you follow the [Safety instructions](#).
2. Follow the procedure listed in [Before working inside your system](#).
3. Locate the Internal Dual SD Module (IDSDM) on the system board.
4. If installed, remove the SD card(s).

## Steps

Hold the pull tab and pull the IDSDM out of the system.

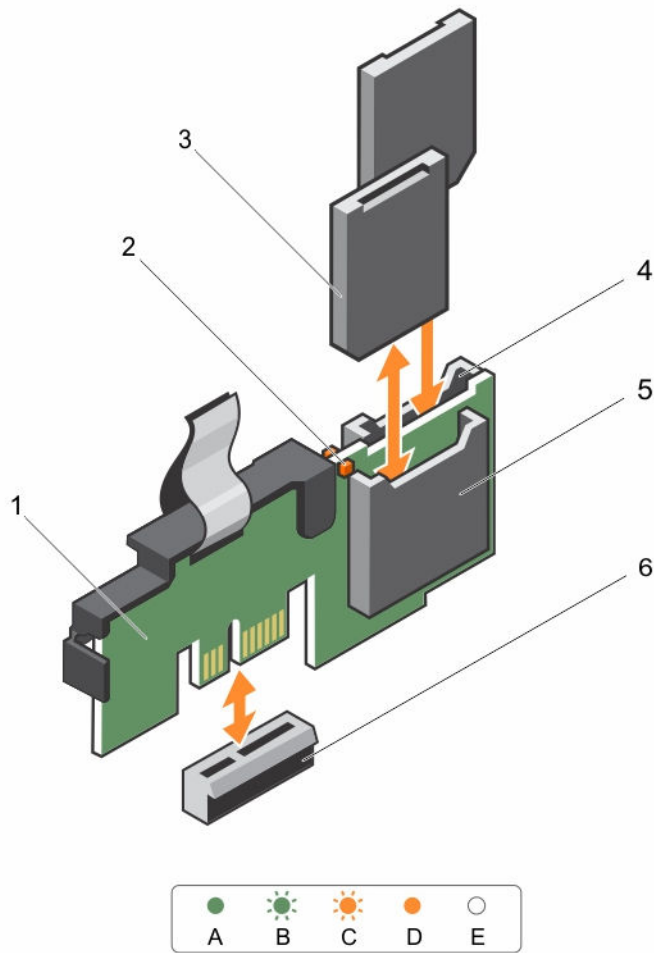

**Figure 38. Removing and installing the Internal Dual SD Module (IDSDM)**

- |                   |                             |
|-------------------|-----------------------------|
| 1. IDSDM          | 2. LED status indicator (2) |
| 3. SD card (2)    | 4. SD card slot 2           |
| 5. SD card slot 1 | 6. IDSDM connector          |

The following table describes the IDSDM indicator codes:

**Table 16. IDSDM indicator codes**

Convention	IDSDM indicator code	Condition
A	Green	Indicates that the card is online
B	Flashing green	Indicates rebuild or activity
C	Flashing amber	Indicates card mismatch or that the card has failed

Convention	IDSDM indicator code	Condition
D	Amber	Indicates that the card is offline, has failed, or is write-protected
E	Not lit	Indicates that the card is missing or is booting

#### Next steps

1. Install the internal dual SD module.
2. Follow the procedure listed in [After working inside your system](#).

#### Related Links

- [Removing an optional internal SD card](#)
- [Installing the optional internal dual SD module](#)

## Installing the optional internal dual SD module

#### Prerequisites

 **CAUTION:** Many repairs may only be done by a certified service technician. You should only perform troubleshooting and simple repairs as authorized in your product documentation, or as directed by the online or telephone service and support team. Damage due to servicing that is not authorized by Dell is not covered by your warranty. Read and follow the safety instructions that are shipped with your product.

1. Ensure that you follow the [Safety instructions](#).
2. Follow the procedure listed in [Before working inside your system](#).

#### Steps

1. Locate the Internal Dual SD Module (IDSDM) connector on the system board.
2. Align the IDSDM with the IDSDM connector on the system board.
3. Push the IDSDM until it is firmly seated on the system board.

#### Next steps

1. Install the SD card(s).
  -  **NOTE:** Temporarily label each SD card with its corresponding slot before removal. Replace the SD card(s) into the same slots.
2. Follow the procedure listed in [After working inside your system](#).

#### Related Links

- [Installing an optional internal SD card](#)

## Heat sink and processor

## Removing the heat sink

### Prerequisites

 **CAUTION:** Many repairs may only be done by a certified service technician. You should only perform troubleshooting and simple repairs as authorized in your product documentation, or as directed by the online or telephone service and support team. Damage due to servicing that is not authorized by Dell is not covered by your warranty. Read and follow the safety instructions that are shipped with your product.

 **CAUTION:** Never remove the heat sink from a processor unless you intend to remove the processor. The heat sink is necessary to maintain proper thermal conditions.

 **NOTE:** This is a Field Replaceable Unit (FRU). Removal and installation procedures should be performed only by Dell certified service technicians.

1. Ensure that you follow the [Safety instructions](#).
2. Keep the Phillips #2 screwdriver ready.
3. Follow the procedure listed in [Before working inside your system](#).
4. Remove the cooling shroud.

 **WARNING:** The heat sink and processor are too hot to touch for some time after the system has been powered down. Allow the heat sink and processor to cool down before handling them.

### Steps

1. Loosen one of the screws that secure the heat sink to the system board.  
Allow some time (around 30 seconds) for the heat sink to loosen from the processor.
2. Loosen the screw that is diagonally opposite the screw you first removed.
3. Repeat the procedure for the remaining two screws.
4. Lift the heat sink away from the system.

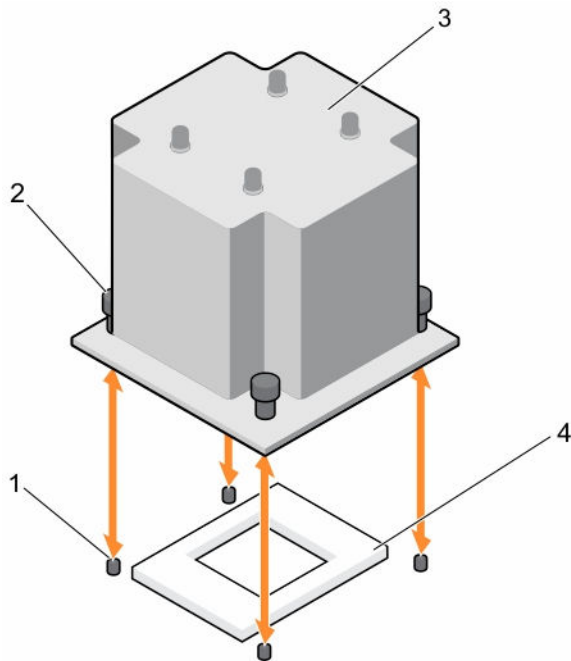

**Figure 39. Removing and installing a heat sink**

- |              |                       |
|--------------|-----------------------|
| 1. slots (4) | 2. captive screws (4) |
| 3. heat sink | 4. processor socket   |

#### Next steps

1. If you are removing only a faulty heat sink, install the replacement heat sink, if not, remove the processor.
2. Follow the procedure listed in [After working inside your system](#).

#### Related Links

- [Removing the cooling shroud](#)
- [Installing the heat sink](#)
- [Installing the processor](#)
- [Installing the cooling shroud](#)

## Removing the processor

#### Prerequisites

**⚠ CAUTION:** Many repairs may only be done by a certified service technician. You should only perform troubleshooting and simple repairs as authorized in your product documentation, or as directed by the online or telephone service and support team. Damage due to servicing that is not authorized by Dell is not covered by your warranty. Read and follow the safety instructions that are shipped with your product.

**🔧 NOTE:** This is a Field Replaceable Unit (FRU). Removal and installation procedures should be performed only by Dell certified service technicians.

1. Ensure that you follow the [Safety instructions](#).
2. Keep the Phillips #2 screwdriver ready.

3. If you are upgrading your system, download the latest system BIOS version from [Dell.com/support](https://Dell.com/support) and follow the instructions included in the compressed download file to install the update on your system.



**NOTE:** You can update the system BIOS by using the Dell Lifecycle Controller.

4. Follow the procedure listed in [Before working inside your system](#).
5. Remove the cooling shroud.
6. Remove the heat sink.



**WARNING:** The processor will be hot to touch for some time after the system has been powered down. Allow the processor to cool before removing it.



**CAUTION:** The processor is held in its socket under strong pressure. Be aware that the release lever can spring up suddenly if not firmly held.

#### Steps

1. Release the socket lever by pushing the lever down and out from under the tab on the processor shield.
2. Lift the lever upward until the processor shield lifts.



**CAUTION:** The processor socket pins are fragile and can be permanently damaged. Be careful not to bend the pins in the processor socket when removing the processor out of the socket.

3. Lift the processor out of the socket.



**NOTE:** After removing the processor, place it in an antistatic container for reuse, return, or temporary storage. Do not touch the bottom of the processor to avoid damage to the processor contacts. Touch only the side edges of the processor.

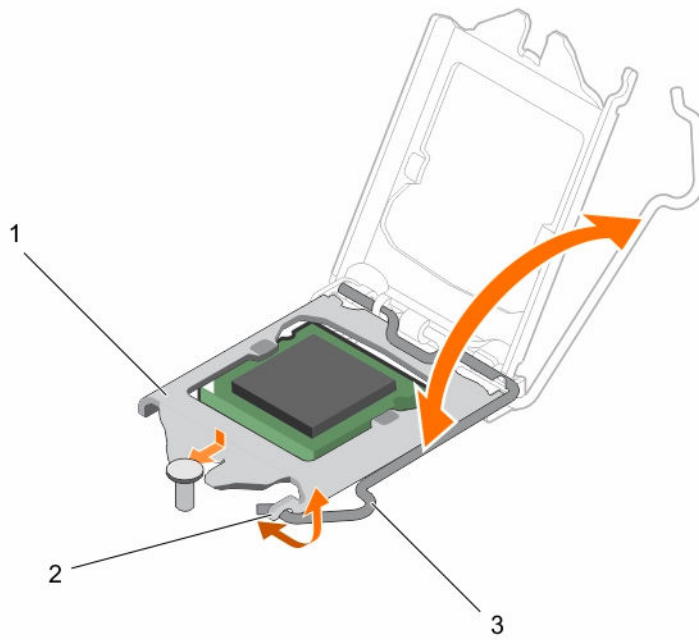

**Figure 40. Opening and closing the processor shield**

- 1. processor shield
- 2. tab on the processor shield
- 3. socket lever

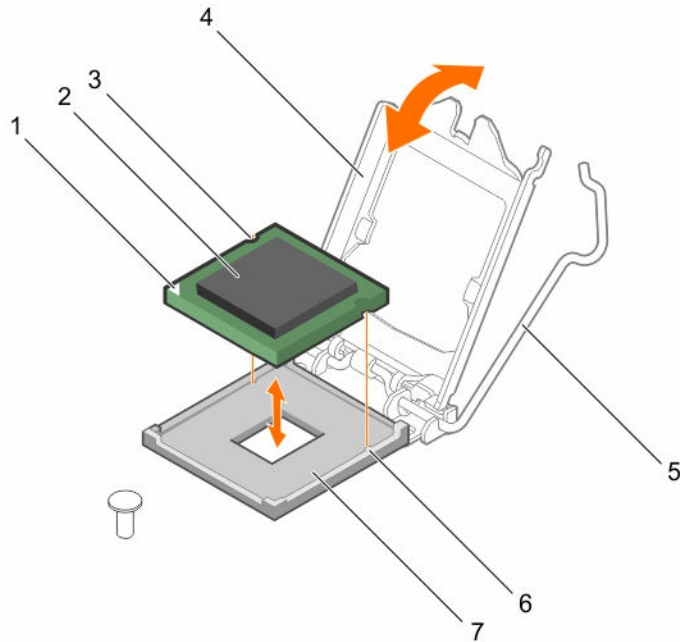

**Figure 41. Removing and installing a processor**

- |                                 |                     |
|---------------------------------|---------------------|
| 1. pin-1 indicator of processor | 2. processor        |
| 3. slot (2)                     | 4. processor shield |
| 5. socket lever                 | 6. socket keys (2)  |
| 7. socket                       |                     |

#### Next steps

1. Replace the processor.
2. Follow the procedure listed in [After working inside your system](#).

#### Related Links

- [Removing the cooling shroud](#)
- [Installing the processor](#)
- [Removing the cooling shroud](#)
- [Removing the heat sink](#)
- [Installing the processor](#)
- [Installing the heat sink](#)
- [Installing the cooling shroud](#)

## Installing the processor

#### Prerequisites

- ⚠ CAUTION:** Many repairs may only be done by a certified service technician. You should only perform troubleshooting and simple repairs as authorized in your product documentation, or as directed by the online or telephone service and support team. Damage due to servicing that is not authorized by Dell is not covered by your warranty. Read and follow the safety instructions that are shipped with your product.



 **NOTE:** This is a Field Replaceable Unit (FRU). Removal and installation procedures should be performed only by Dell certified service technicians.

1. Ensure that you follow the [Safety instructions](#).
2. If you are upgrading your system, download the latest system BIOS version from [Dell.com/support](#) and follow the instructions included in the compressed download file to install the update on your system.

 **NOTE:** You can update the system BIOS by using the Dell Lifecycle Controller.

3. Follow the procedure listed in [Before working inside your system](#).
4. Remove the cooling shroud.

### Steps

1. Unpack the new processor.

If the processor has previously been used in a system, remove any remaining thermal grease from the processor by using a lint free cloth.

2. Locate the processor socket.

 **CAUTION:** While removing or reinstalling the processor, wipe your hands of any contaminants. Contaminants on the processor contacts such as thermal grease or oil can damage the processor.

3. Align the processor with the socket keys.

 **CAUTION:** Do not use force to seat the processor. When the processor is positioned correctly, it engages easily into the socket.

 **CAUTION:** Positioning the processor incorrectly can permanently damage the system board or the processor. Be careful not to bend the pins in the socket.

4. Align the pin-1 indicator of the processor with the triangle on the socket.
5. Place the processor on the socket such that the slots on the processor align with the socket keys.
6. Close the processor shield by sliding it under the retention screw.
7. Lower the socket lever and push it under the tab to lock it.

### Next steps

 **NOTE:** Ensure that you install the heat sink after you install the processor. The heat sink is necessary to maintain proper thermal conditions.

1. Install the heat sink.
2. Follow the procedure listed in [After working inside your system](#).
3. While booting, press F2 to enter System Setup and check that the processor information matches the new system configuration.
4. Run the system diagnostics to verify that the new processor operates correctly.

### Related Links

[Removing the cooling shroud](#)

[Installing the cooling shroud](#)

[Removing the processor](#)

[Removing the cooling shroud](#)

[Installing the heat sink](#)

[Installing the cooling shroud](#)

## Installing the heat sink

### Prerequisites

 **CAUTION:** Many repairs may only be done by a certified service technician. You should only perform troubleshooting and simple repairs as authorized in your product documentation, or as directed by the online or telephone service and support team. Damage due to servicing that is not authorized by Dell is not covered by your warranty. Read and follow the safety instructions that are shipped with your product.

 **NOTE:** This is a Field Replaceable Unit (FRU). Removal and installation procedures should be performed only by Dell certified service technicians.

1. Ensure that you follow the [Safety instructions](#).
2. Keep the Phillips #2 screwdriver ready.
3. Follow the procedure listed in [Before working inside your system](#).
4. Remove the cooling shroud.
5. Install the processor.

### Steps

1. If you are using an existing heat sink, remove the thermal grease from the heat sink by using a clean lint free cloth.
2. Use the thermal grease syringe included with your processor kit to apply the grease in a thin spiral on the top of the processor as shown in the following figure.

 **CAUTION:** Applying too much thermal grease can result in excess grease coming in contact with and contaminating the processor socket.

 **NOTE:** The thermal grease syringe is intended for one-time use only. Dispose of the syringe after you use it.

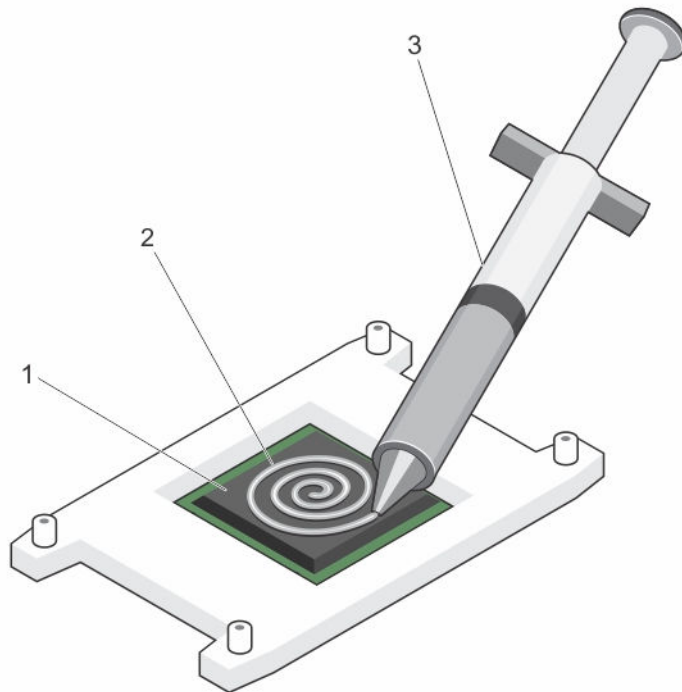

**Figure 42. Applying thermal grease on the top of the processor**

1. processor
  2. thermal grease
  3. thermal grease syringe
3. Place the heat sink onto the processor.
  4. Tighten one of the four screws to secure the heat sink to the system board.
  5. Tighten the screw diagonally opposite to the first screw you tightened.
    - **NOTE:** Do not overtighten the heat sink retention screws when installing the heat sink. To prevent overtightening, tighten the retention screw until resistance is felt. The screw tension must not be more than 6 in-lb (6.9 kg-cm).
  6. Repeat the procedure for the remaining two screws.

#### Next steps

1. Install the cooling shroud.
2. Follow the procedure listed in [After working inside your system](#).
3. While booting, press F2 to enter System Setup and check that the processor information matches the new system configuration.
4. Run the system diagnostics to verify that the new processor operates correctly.

#### Related Links

- [Removing the cooling shroud](#)
- [Installing the processor](#)
- [Installing the cooling shroud](#)

# Power supply units

## Redundant AC power supply unit

Your system supports up to two 495 W (Platinum) AC power supply units (PSUs).

 **NOTE:** When two identical PSUs are installed, power supply redundancy (1+1 – with redundancy or 2+0 – without redundancy) is configured in system BIOS. In redundant mode, power is supplied to the system equally from both PSUs when Hot Spare is disabled. When Hot Spare is enabled, one of the PSUs will be put into standby when system utilization is low in order to maximize efficiency.

 **CAUTION:** If two PSUs are used, they must be of the same maximum output power.

 **NOTE:** For AC PSUs, use only PSUs with the Extended Power Performance (EPP) label on the back. Mixing PSUs from previous generations of servers can result in a power supply mismatch condition or failure to power on.

## Hot spare feature

Your system supports the hot spare feature that significantly reduces the power overhead associated with power supply redundancy.

When the hot spare feature is enabled, one of the redundant PSUs is switched to the sleep state. The active PSU supports 100 percent of the load, thus operating at higher efficiency. The PSU in the sleep state monitors output voltage of the active PSU. If the output voltage of the active PSU drops, the PSU in the sleep state returns to an active output state.

If having both PSUs active is more efficient than having one PSU in the sleep state, the active PSU can also activate the sleeping PSU.

The default PSU settings are as follows:

- If the load on the active PSU is more than 50 percent, then the redundant PSU is switched to the active state.
- If the load on the active PSU falls below 20 percent, then the redundant PSU is switched to the sleep state.

You can configure the hot spare feature by using the iDRAC settings. For more information about iDRAC settings, see the *Integrated Dell Remote Access Controller User's Guide* available at [Dell.com/idracmanuals](http://Dell.com/idracmanuals).

## Removing a redundant AC power supply unit

### Prerequisites

 **CAUTION:** Many repairs may only be done by a certified service technician. You should only perform troubleshooting and simple repairs as authorized in your product documentation, or as directed by the online or telephone service and support team. Damage due to servicing that is not authorized by Dell is not covered by your warranty. Read and follow the safety instructions that are shipped with your product.

 **CAUTION:** The system requires one power supply unit (PSU) for normal operation. On power-redundant systems, remove and replace only one power supply at a time in a system that is powered on.

1. Ensure that you follow the [Safety instructions](#).
2. Disconnect the power cable from the power source and from the PSU you intend to remove and remove the cables from the strap.

 **NOTE:** You may have to unlatch and lift the optional cable management arm if it interferes with PSU removal. For information about the cable management arm, see the system's rack documentation.

#### Steps

1. Press the release latch.
2. Holding the PSU handle, pull the PSU out of the PSU bay to release the PSU from the Power Distribution Board (PDB).

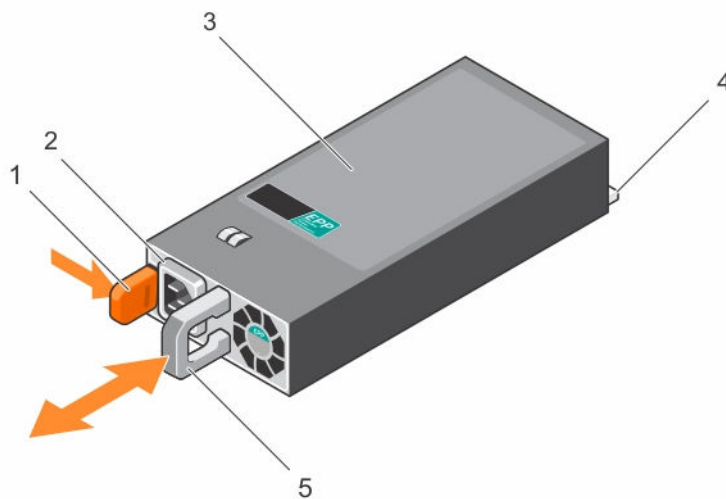

**Figure 43. Removing and installing an AC PSU**

- |                  |                        |
|------------------|------------------------|
| 1. release latch | 2. PSU cable connector |
| 3. PSU           | 4. connector           |
| 5. PSU handle    |                        |

#### Next steps

If you are not replacing the PSU in the second PSU bay immediately, install the PSU blank in the empty PSU bay.

#### Related Links

[Installing the power supply unit blank](#)

[Installing a redundant AC power supply unit](#)

## Installing a redundant AC power supply unit

### Prerequisites

 **CAUTION:** Many repairs may only be done by a certified service technician. You should only perform troubleshooting and simple repairs as authorized in your product documentation, or as directed by the online or telephone service and support team. Damage due to servicing that is not authorized by Dell is not covered by your warranty. Read and follow the safety instructions that are shipped with your product.

1. Ensure that you follow the [Safety instructions](#).
2. Verify that both the power supply units (PSUs) are the same type and have the same maximum output power.

 **NOTE:** The maximum output power (shown in watts) is listed on the PSU label.

3. If installed, remove the PSU blank.

### Steps

Slide the new PSU into the chassis until the PSU is fully seated and the release latch snaps into place.

 **NOTE:** If you unlatched the cable management arm, re-latch it. For information about the cable management arm, see the system's rack documentation.

### Next steps

Connect the power cable to the PSU, and plug the cable into a power outlet.

 **CAUTION:** When connecting the power cable, secure the cable with the strap.

 **NOTE:** When installing, hot-swapping, or hot-adding a new PSU, wait for 15 seconds for the system to discover the PSU and determine its status. The power supply redundancy may not occur until discovery is complete. Wait until the new PSU is discovered and enabled before you remove the old PSU. The PSU status indicator turns green to indicate that the PSU is functioning properly.

### Related Links

[Removing the power supply unit blank](#)

## Removing the power supply unit blank

### Prerequisites

Ensure that you follow the [Safety instructions](#).

### Steps

If you are installing a second power supply unit (PSU), remove the PSU blank in the bay by pulling the blank outward.

 **CAUTION:** To ensure proper system cooling, the PSU blank must be installed in the second PSU bay in a non-redundant configuration. Remove the PSU blank only if you are installing a second PSU.

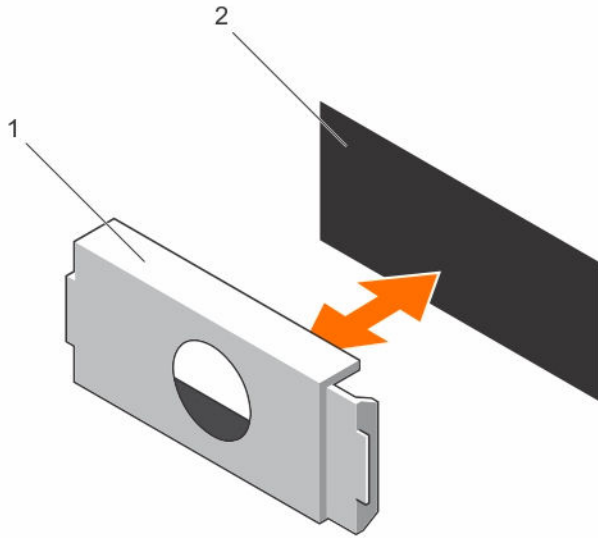

**Figure 44. Removing and installing the PSU blank**

1. PSU blank

2. PSU bay

#### Next steps

Install the PSU or PSU blank.

#### Related Links

[Installing the power supply unit blank](#)

[Installing a redundant AC power supply unit](#)

#### Installing the power supply unit blank

Install the power supply unit (PSU) blank only in the second PSU bay.

#### Prerequisites

**CAUTION:** To ensure proper system cooling, the PSU blank must be installed in the second PSU bay in a non-redundant configuration. Remove the PSU blank only if you are installing a second PSU.

#### Steps

Align the PSU blank with the PSU bay, and push the PSU blank into the chassis until it clicks into place.

#### Replacing the power supply unit divider

#### Prerequisites

**CAUTION:** Many repairs may only be done by a certified service technician. You should only perform troubleshooting and simple repairs as authorized in your product documentation, or as directed by the online or telephone service and support team. Damage due to servicing that is not authorized by Dell is not covered by your warranty. Read and follow the safety instructions that are shipped with your product.

1. Turn off the system, including any attached peripherals, and disconnect the system from the electrical outlet and peripherals.
2. If installed, remove the redundant power supply units (PSUs) or PSU blank.

### Steps

1. Remove the screw that secures the PSU divider to the chassis.
2. Slide out the PSU divider and turn it clockwise to free the tabs on the PSU divider from the slots on the PSU cage.
3. Slide the PSU divider out of the chassis.
4. Align the tabs of the new PSU divider with the slots of the PSU cage.
5. Turn the PSU divider counterclockwise and slide it in until the PSU divider is seated on the slots of the PSU cage.
6. Tighten the screw to secure the PSU divider to the chassis.

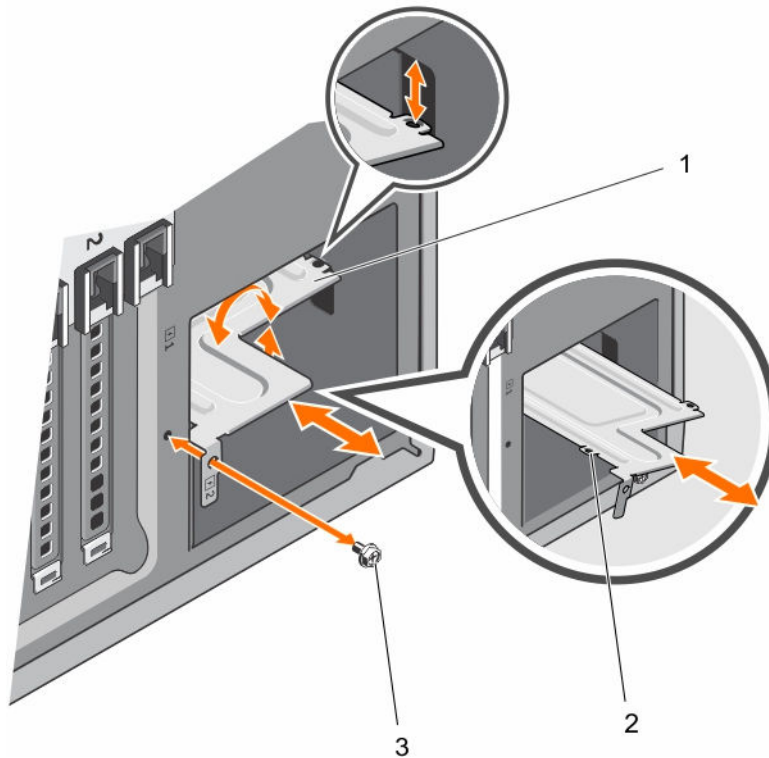

**Figure 45. Removing and installing the PSU divider**

- |                |             |
|----------------|-------------|
| 1. PSU divider | 2. tabs (4) |
| 3. screw       |             |

### Next steps

1. Install the redundant PSUs or PSU blank as applicable.
2. Reconnect the system to its electrical outlet and power on the system, including any attached peripherals.

### Related Links

[Removing a redundant AC power supply unit](#)

[Removing the power supply unit blank](#)

[Installing a redundant AC power supply unit](#)

[Installing the power supply unit blank](#)



## Non-redundant AC power supply unit

Your system supports a non-redundant 350 W AC power supply unit (PSU).

 **NOTE:** When selecting or upgrading your system configuration, verify the system power consumption with the Dell Energy Smart Solution Advisor at [Dell.com/ESSA](https://www.dell.com/ESSA) to ensure optimum power utilization.

### Removing a non-redundant AC power supply unit

#### Prerequisites

 **CAUTION:** Many repairs may only be done by a certified service technician. You should only perform troubleshooting and simple repairs as authorized in your product documentation, or as directed by the online or telephone service and support team. Damage due to servicing that is not authorized by Dell is not covered by your warranty. Read and follow the safety instructions that are shipped with your product.

1. Ensure that you follow the [Safety instructions](#).
2. Follow the procedure listed in [Before working inside your system](#).

#### Steps

1. Disconnect all the power cables from the power supply unit (PSU) to the system board, hard drive backplane, hard drives, and optical drives.
2. Remove the screw securing the PSU to the chassis and slide the PSU out of the PSU cage.

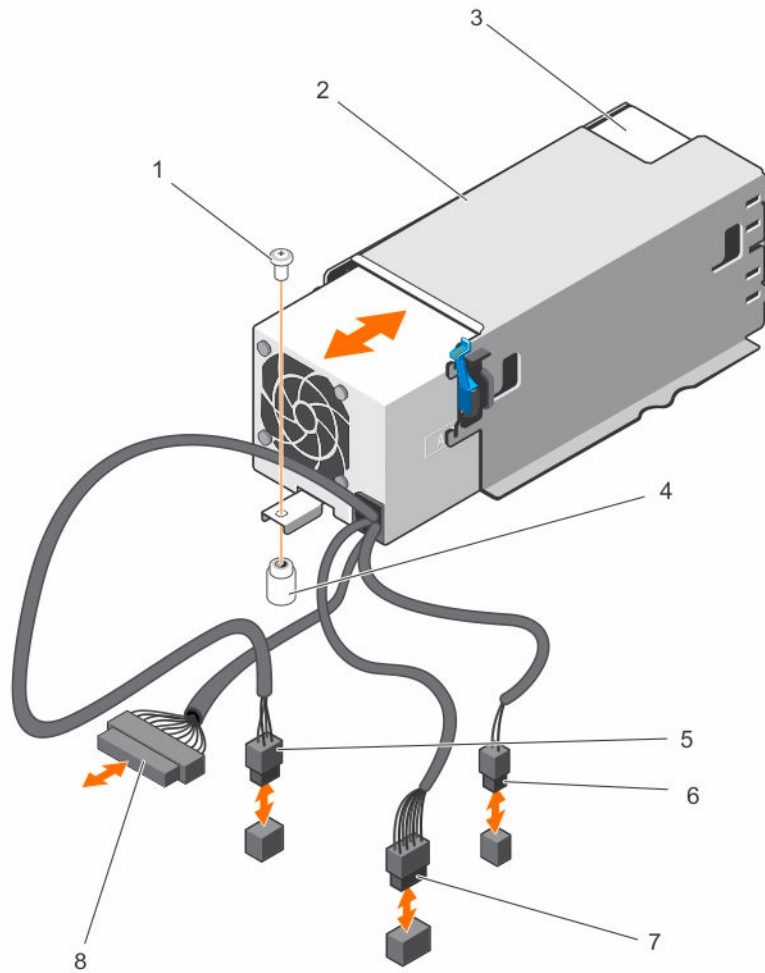

**Figure 46. Removing and installing a non-redundant AC PSU**

- |                             |                              |
|-----------------------------|------------------------------|
| 1. screw                    | 2. PSU cage                  |
| 3. non-redundant PSU        | 4. standoff on the chassis   |
| 5. P2 power cable connector | 6. P1 signal cable connector |
| 7. P1 power cable connector | 8. P4/backplane connector    |

#### Next steps

1. Install a non-redundant PSU.
2. Follow the procedure listed in [After working inside your system](#).

#### Related Links

[Installing a non-redundant AC power supply unit](#)

## Installing a non-redundant AC power supply unit

### Prerequisites

 **CAUTION:** Many repairs may only be done by a certified service technician. You should only perform troubleshooting and simple repairs as authorized in your product documentation, or as directed by the online or telephone service and support team. Damage due to servicing that is not authorized by Dell is not covered by your warranty. Read and follow the safety instructions that are shipped with your product.

1. Ensure that you follow the [Safety instructions](#).
2. Unpack the new power supply unit (PSU).

### Steps

1. Slide the new PSU into the PSU cage until the PSU is fully seated.
2. Tighten the screw to secure the PSU to the chassis.
3. Connect all the power cables from the PSU to the system board, hard drive backplane, hard drives, and optical drives.

### Next steps

Follow the procedure listed in [After working inside your system](#).

## Power interposer board

The power interposer board is only supported in systems with redundant power supply units.

## Removing the power interposer board

### Prerequisites

 **CAUTION:** Many repairs may only be done by a certified service technician. You should only perform troubleshooting and simple repairs as authorized in your product documentation, or as directed by the online or telephone service and support team. Damage due to servicing that is not authorized by Dell is not covered by your warranty. Read and follow the safety instructions that are shipped with your product.

1. Ensure that you follow the [Safety instructions](#).
2. Follow the procedure listed in [Before working inside your system](#).

 **CAUTION:** To prevent damage to the power interposer board, you must remove the power supply units (PSUs) or PSU blank from the system before removing the power interposer board (PIB).

3. Remove the PSUs or PSU blanks from the back of the chassis.
4. Remove the cooling shroud.

### Steps

1. Disconnect the power cables from the hard drive backplane and the system board.
2. Pressing the release latch on the PIB, lift the PIB to release it from the hooks on the PSU cage.
3. Lift the PIB out of the chassis.

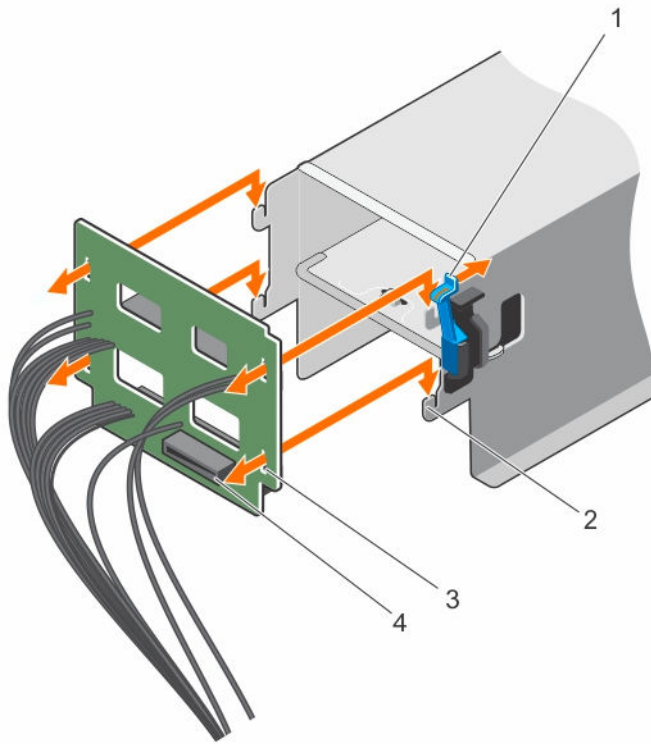

**Figure 47. Removing and installing the PIB**

- |                  |                  |
|------------------|------------------|
| 1. release latch | 2. hooks (4)     |
| 3. slots (4)     | 4. PIB connector |

#### Next steps

1. Install the PIB.
2. Follow the procedure listed in [After working inside your system](#).

#### Related Links

- [Removing a redundant AC power supply unit](#)
- [Removing the power supply unit blank](#)
- [Removing the cooling shroud](#)
- [Installing the power interposer board](#)

## Installing the power interposer board

#### Prerequisites

**⚠ CAUTION:** Many repairs may only be done by a certified service technician. You should only perform troubleshooting and simple repairs as authorized in your product documentation, or as directed by the online or telephone service and support team. Damage due to servicing that is not authorized by Dell is not covered by your warranty. Read and follow the safety instructions that are shipped with your product.

Ensure that you follow the [Safety instructions](#).

### Steps

1. Align the slots on the power interposer board (PIB) with the hooks on the power supply unit (PSU) cage and slide the PIB until it snaps into place.
2. Route the power cables through the securing clips as applicable, and connect the power cables to the system board.

### Next steps

1. Install the cooling shroud.
2. Install the PSUs or PSU blank.
3. Follow the procedure listed in [After working inside your system](#).

### Related Links

[Installing the cooling shroud](#)

[Installing a redundant AC power supply unit](#)

[Installing the power supply unit blank](#)

## System battery

The system board battery is used for low-level system functions like powering the real-time clock and storing the computer's BIOS settings.

### Replacing the system battery

#### Prerequisites

1. Ensure that you follow the [Safety instructions](#).
2. Follow the procedure listed in [Before working inside your system](#).
3. Remove the cooling shroud.
4. Keep the plastic scribe ready.



**WARNING:** There is a danger of a new battery exploding if it is incorrectly installed. Replace the battery only with the same or equivalent type recommended by the manufacturer. For more information, see the safety information that shipped with your system.



**CAUTION:** Many repairs may only be done by a certified service technician. You should only perform troubleshooting and simple repairs as authorized in your product documentation, or as directed by the online or telephone service and support team. Damage due to servicing that is not authorized by Dell is not covered by your warranty. Read and follow the safety instructions that are shipped with your product.



**NOTE:** This is a Field Replaceable Unit (FRU). Removal and installation procedures must be performed only by Dell certified service technicians.

#### Steps

1. Locate the battery socket. For more information, see [System board jumpers and connectors](#).



**CAUTION:** To avoid damage to the battery connector, you must firmly support the connector while installing or removing a battery.

2. Use a plastic scribe to pry out the system battery as shown in the following illustration:

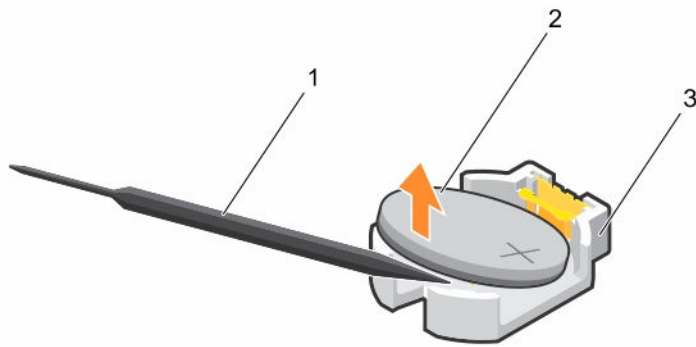

**Figure 48. Removing the system battery**

1. plastic scribe
2. positive side of the battery connector
3. securing tabs
3. Install a new system battery by holding the battery with the "+" sign facing up and slide it under the securing tabs.
4. Press the battery into the connector until it snaps into place.

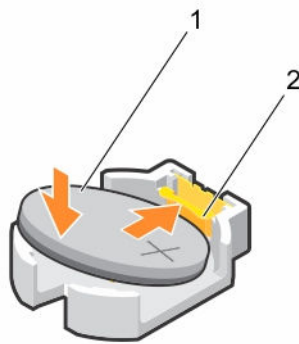

**Figure 49. Installing the system battery**

1. positive side of the battery connector
2. battery connector

#### Next steps

1. Install the cooling shroud.
2. Follow the procedure listed in [After working inside your system](#).
3. While booting, press F2 to enter System Setup and ensure that the battery is operating properly.
4. Enter the correct time and date in the System Setup **Time** and **Date** fields.
5. Exit System Setup.

#### Related Links

[Removing the cooling shroud](#)

[Installing the cooling shroud](#)

# Control panel assembly

## Removing the control panel assembly

### Prerequisites

 **CAUTION:** Many repairs may only be done by a certified service technician. You should only perform troubleshooting and simple repairs as authorized in your product documentation, or as directed by the online or telephone service and support team. Damage due to servicing that is not authorized by Dell is not covered by your warranty. Read and follow the safety instructions that are shipped with your product.

1. Ensure that you follow the [Safety instructions](#).
2. Keep the Phillips #2 screwdriver ready.
3. Follow the procedure listed in [Before working inside your system](#).
4. Remove the optical drive and tape drives.

### Steps

1. Remove the screw securing the control panel to the chassis.
2. Disconnect the control panel cable and the control panel USB cable from the system board.

 **CAUTION:** Do not use excessive force when removing the control panel cables as it can damage the connectors.

3. Slide the control panel out of the chassis.
4. Disconnect the control panel cable and the control panel USB cable from the control panel.

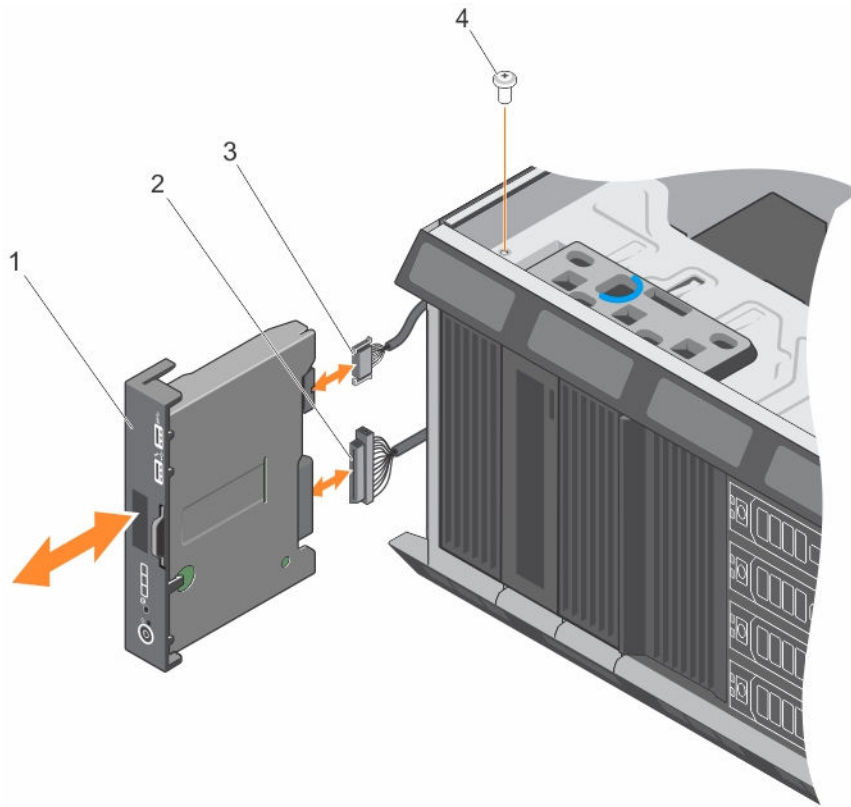
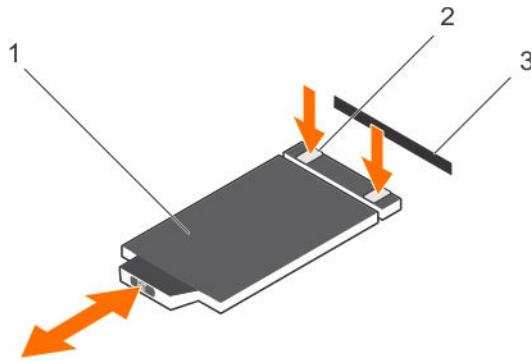

**Figure 50. Removing and installing the control panel assembly**

1. control panel
  2. control panel cable
  3. control panel USB cable
  4. screw
5. Locate and press the tabs on the information tag.
6. Push the information tag out of the slot to remove it from the control panel.

 **NOTE:** Retain the information tag to replace it in the new control panel.





**Figure 51. Removing and installing the information tag**

1. information tag
2. tab (2)
3. slot

#### Next steps

1. Install the control panel assembly.
2. Follow the procedure listed in [After working inside your system](#).

#### Related Links

- [Preparing a system for conversion from tower mode to rack mode](#)
- [Removing the optional optical drive or tape drive](#)
- [Installing the control panel assembly](#)
- [Installing the optical drive or tape drive](#)

## Installing the control panel assembly

#### Prerequisites

**⚠ CAUTION:** Many repairs may only be done by a certified service technician. You should only perform troubleshooting and simple repairs as authorized in your product documentation, or as directed by the online or telephone service and support team. Damage due to servicing that is not authorized by Dell is not covered by your warranty. Read and follow the safety instructions that are shipped with your product.

1. Ensure that you follow the [Safety instructions](#).
2. Keep the Phillips #2 screwdriver ready.

#### Steps

1. Replace the blank information tag in the new control panel with the information tag retained from the old control panel.

**📌 NOTE:** Information tag lists system information such as Service Tag, NIC, MAC address.

2. To install the information tag, push the information tag into the control panel slot.
3. Connect the control panel cable and the control panel USB cable to the control panel module.

4. Align and insert the control panel into the control panel slot in the chassis.
5. Tighten the screw to secure the control panel to the chassis.
6. Connect the control panel cable and the control panel USB cable to the system board.

#### Next steps

1. Install the optical drive and tape drives.
2. Follow the procedure listed in [After working inside your system](#).

#### Related Links

[Preparing a system for conversion from tower mode to rack mode](#)

[Installing the optical drive or tape drive](#)

[Removing the control panel assembly cover](#)

## Removing the control panel assembly cover

#### Prerequisites

 **CAUTION:** Many repairs may only be done by a certified service technician. You should only perform troubleshooting and simple repairs as authorized in your product documentation, or as directed by the online or telephone service and support team. Damage due to servicing that is not authorized by Dell is not covered by your warranty. Read and follow the safety instructions that came with the product.

1. Ensure that you follow the [Safety instructions](#).
2. Follow the procedure listed in [Before working inside your system](#).
3. Remove the control panel assembly.

#### Steps

1. Unhook the tab adjacent to the power button.
2. Unhook the tab on the bottom of the control panel assembly cover.
3. Pull the control panel assembly cover to detach it from the control panel.

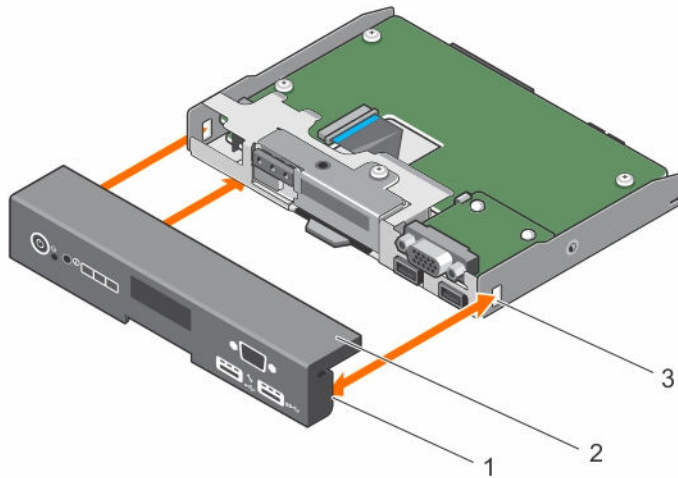

Figure 52. Removing and installing the control panel assembly cover for system with LCD panel

#### Next steps

1. Install the control panel assembly cover.
2. Follow the procedure listed in [After working inside your system](#).

#### Related Links

[Removing the control panel assembly](#)

[Installing the control panel assembly cover](#)

[Preparing a system for conversion from tower mode to rack mode](#)

## Installing the control panel assembly cover

#### Prerequisites

**⚠ CAUTION:** Many repairs may only be done by a certified service technician. You should only perform troubleshooting and simple repairs as authorized in your product documentation, or as directed by the online or telephone service and support team. Damage due to servicing that is not authorized by Dell is not covered by your warranty. Read and follow the safety instructions that came with the product.

1. Ensure that you follow the [Safety instructions](#).
2. Follow the procedure listed in [Before working inside your system](#).

#### Steps

1. Align the tabs on the control panel assembly cover with the slots on the control panel.
2. Push the cover until the tabs lock into place.

#### Next steps

1. Install the control panel assembly.
2. Follow the procedure listed in [After working inside your system](#).

## Related Links

[Installing the control panel assembly](#)

[Preparing a system for conversion from tower mode to rack mode](#)

## Removing the control panel board

### Prerequisites



**CAUTION:** Many repairs may only be done by a certified service technician. You should only perform troubleshooting and simple repairs as authorized in your product documentation, or as directed by the online or telephone service and support team. Damage due to servicing that is not authorized by Dell is not covered by your warranty. Read and follow the safety instructions that are shipped with your product.

1. Ensure that you follow the [Safety instructions](#).
2. Keep the Phillips #2 screwdriver ready.
3. Follow the procedure listed in [Before working inside your system](#).
4. Remove the control panel assembly.
5. Remove the control panel assembly cover.

### Steps

1. Remove the screws that secure the control panel board to the control panel.
2. Lift the control panel board until the control panel board disengages from the slots on the control panel.
3. Slide the control panel board toward the back of the control panel, and lift the control panel board away from the control panel.

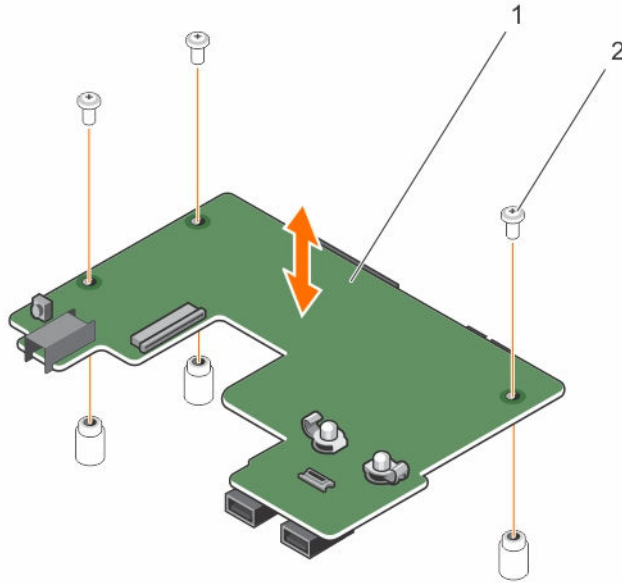

**Figure 53. Removing and installing the control panel board for systems with hot swappable hard drives**

1. control panel board
2. screw (3)

#### Next steps

1. Install the control panel board.
2. Follow the procedure listed in [After working inside your system](#).

#### Related Links

[Installing the control panel board](#)

## Installing the control panel board

#### Prerequisites

**⚠ CAUTION:** Many repairs may only be done by a certified service technician. You should only perform troubleshooting and simple repairs as authorized in your product documentation, or as directed by the online or telephone service and support team. Damage due to servicing that is not authorized by Dell is not covered by your warranty. Read and follow the safety instructions that are shipped with your product.

1. Ensure that you follow the [Safety instructions](#).
2. Follow the procedure listed in [Before working inside your system](#).
3. Keep the Phillips #2 screwdriver ready.

#### Steps

1. Align the control panel board with the control panel.

 **CAUTION: Take care not to damage the mylar covering the ID switch.**

2. Slide the control panel board toward the front of the control panel to lock the slide tabs and the screw holes into the respective slots on the control panel.
3. Tighten the screws to secure the control panel board to the control panel.

#### Next steps

1. Install the control panel assembly cover.
2. Install the control panel assembly.
3. Follow the procedure listed in [After working inside your system](#).

#### Related Links

[Installing the control panel assembly cover](#)

[Installing the control panel assembly](#)

## Removing the LCD module

#### Prerequisites

 **CAUTION: Many repairs may only be done by a certified service technician. You should only perform troubleshooting and simple repairs as authorized in your product documentation, or as directed by the online or telephone service and support team. Damage due to servicing that is not authorized by Dell is not covered by your warranty. Read and follow the safety instructions that are shipped with your product.**

1. Ensure that you follow the [Safety instructions](#).
2. Keep the Phillips #2 screwdriver ready.
3. Follow the procedure listed in [Before working inside your system](#).
4. Remove the control panel assembly.
5. Remove the control panel assembly cover.

#### Steps

1. Disconnect the LCD cable. Perform the following steps to disconnect the LCD cable:
  - a. Pull the retention tab that secures the LCD cable to the LCD cable connector on the control panel board.
  - b. Pull the LCD cable out of the LCD cable connector.
2. Remove the screw that secures the LCD module to the control panel.
3. Remove the LCD module out of the control panel assembly.

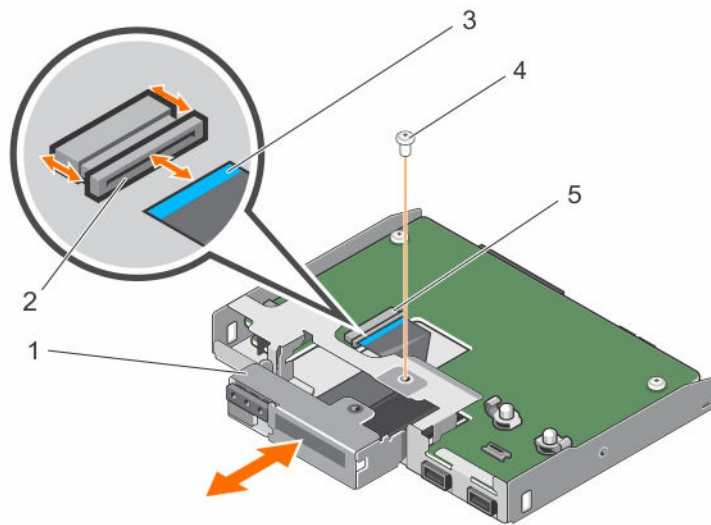

**Figure 54. Removing and Installing the LCD Module**

- |                        |                  |
|------------------------|------------------|
| 1. LCD module          | 2. retention tab |
| 3. LCD cable           | 4. screw         |
| 5. LCD cable connector |                  |

#### Next steps

1. Install the LCD module.
2. Follow the procedure listed in [After working inside your system](#).

#### Related Links

[Removing the control panel assembly](#)

[Removing the control panel assembly cover](#)

[Installing the LCD module](#)

## Installing the LCD module

#### Prerequisites

**⚠ CAUTION:** Many repairs may only be done by a certified service technician. You should only perform troubleshooting and simple repairs as authorized in your product documentation, or as directed by the online or telephone service and support team. Damage due to servicing that is not authorized by Dell is not covered by your warranty. Read and follow the safety instructions that are shipped with your product.

1. Ensure that you follow the [Safety instructions](#).
2. Follow the procedure listed in [Before working inside your system](#).
3. Keep the Phillips #2 screwdriver ready.

#### Steps

1. Align the LCD module with the LCD module slot and insert the LCD module into the control panel.
2. Tighten the screw to secure the LCD module to the control panel.

## Next steps

1. Install the control panel assembly cover.
2. Connect the LCD cable, the control panel cable, and the control panel USB cable to the control panel board.
3. Install the control panel assembly.
4. Connect the control panel cable, the LCD cable, and the control panel USB cable to the system board.
5. Follow the procedure listed in [After working inside your system](#).

## Related Links

[Installing the control panel assembly cover](#)

[Installing the control panel assembly](#)

## Removing the optional VGA module

### Prerequisites

**⚠ CAUTION:** Many repairs may only be done by a certified service technician. You should only perform troubleshooting and simple repairs as authorized in your product documentation, or as directed by the online or telephone service and support team. Damage due to servicing that is not authorized by Dell is not covered by your warranty. Read and follow the safety instructions that are shipped with your product.

1. Ensure that you follow the [Safety instructions](#).
2. Follow the procedure listed in [Before working inside your system](#).
3. Remove the control panel assembly.
4. Remove the control panel assembly cover.

### Steps

Release the hooks that secure the VGA module to the control panel board, and remove the VGA module.

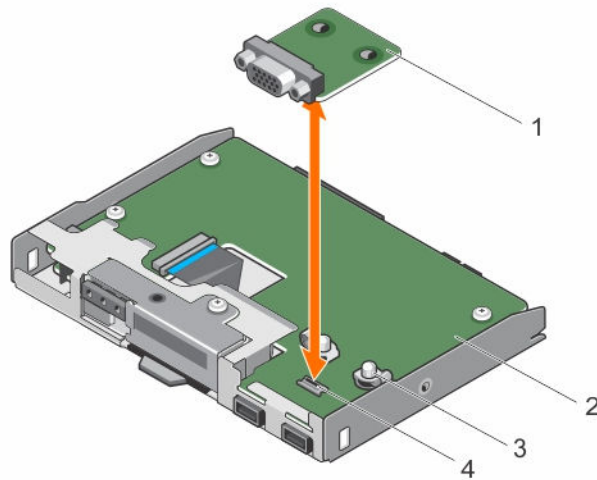

**Figure 55. Removing and installing the optional VGA module**

1. VGA module

2. control panel



3. hook (2)

4. VGA connector on the control panel board

#### Next steps

1. Install the VGA module.
2. Follow the procedure listed in [After working inside your system](#).

#### Related Links

[Removing the control panel assembly](#)

[Removing the control panel assembly cover](#)

[Installing the optional VGA module](#)

## Installing the optional VGA module

#### Prerequisites

 **CAUTION:** Many repairs may only be done by a certified service technician. You should only perform troubleshooting and simple repairs as authorized in your product documentation, or as directed by the online or telephone service and support team. Damage due to servicing that is not authorized by Dell is not covered by your warranty. Read and follow the safety instructions that are shipped with your product.

1. Ensure that you follow the [Safety instructions](#).
2. Follow the procedure listed in [Before working inside your system](#).

#### Steps

1. Align the slots on the VGA module with the VGA connector and hooks on the control panel board.
2. Press the VGA module until the hooks snap into place.

#### Next steps

1. Install the control panel assembly cover.
2. Install the control panel assembly.
3. Follow the procedure listed in [After working inside your system](#).

#### Related Links

[Installing the control panel assembly cover](#)

[Installing the control panel assembly](#)

[Preparing a system for conversion from tower mode to rack mode](#)

## System board

### Removing the system board

#### Prerequisites

 **CAUTION:** Many repairs may only be done by a certified service technician. You should only perform troubleshooting and simple repairs as authorized in your product documentation, or as directed by the online or telephone service and support team. Damage due to servicing that is not authorized by Dell is not covered by your warranty. Read and follow the safety instructions that are shipped with your product.

 **NOTE:** This is a Field Replaceable Unit (FRU). Removal and installation procedures must be performed only by Dell certified service technicians.

 **CAUTION:** If you are using the Trusted Program Module (TPM) with an encryption key, you may be prompted to create a recovery key during program or System Setup. Be sure to create and safely store this recovery key. If you replace this system board, you must supply the recovery key when you restart your system or program before you can access the encrypted data on your hard drives.

 **CAUTION:** Do not attempt to remove the TPM plug-in module from the system board. After the TPM plug-in module is installed, it is cryptographically bound to that specific system board. Any attempt to remove an installed TPM plug-in module breaks the cryptographic binding, and it cannot be re-installed or installed on another system board.

1. Ensure that you follow the [Safety instructions](#).
2. Keep the Phillips #2 screwdriver ready.
3. Follow the procedure listed in [Before working inside your system](#).
4. Remove the following components:
  - a. cooling shroud
  - b. memory modules
  - c. cooling fan
  - d. expansion cards
  - e. heat sink and processor
  - f. iDRAC port card, if installed
  - g. internal dual SD module, if installed

#### Steps

1. Disconnect all cables from the system board.

 **CAUTION:** Take care not to damage the system identification button while removing the system board from the chassis.

2. Remove the screws on the system board, and slide the system board toward the front of the chassis.
3. Hold the system board by the touch points and lift it out of the chassis.

 **CAUTION:** To prevent damage to the system board, do not lift the system board by holding a memory module, processor, or other components; hold the system board by its edges only.

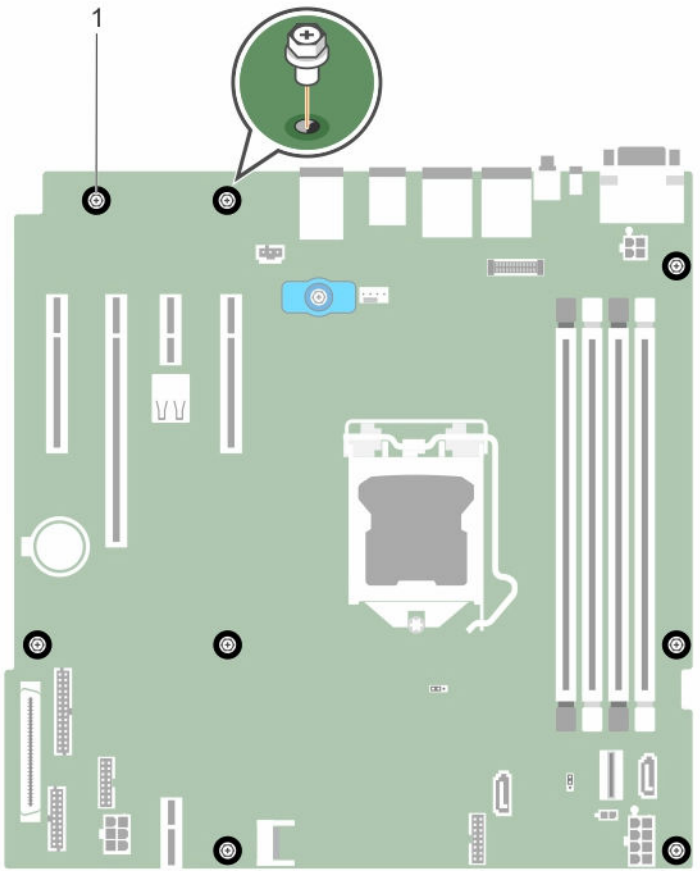
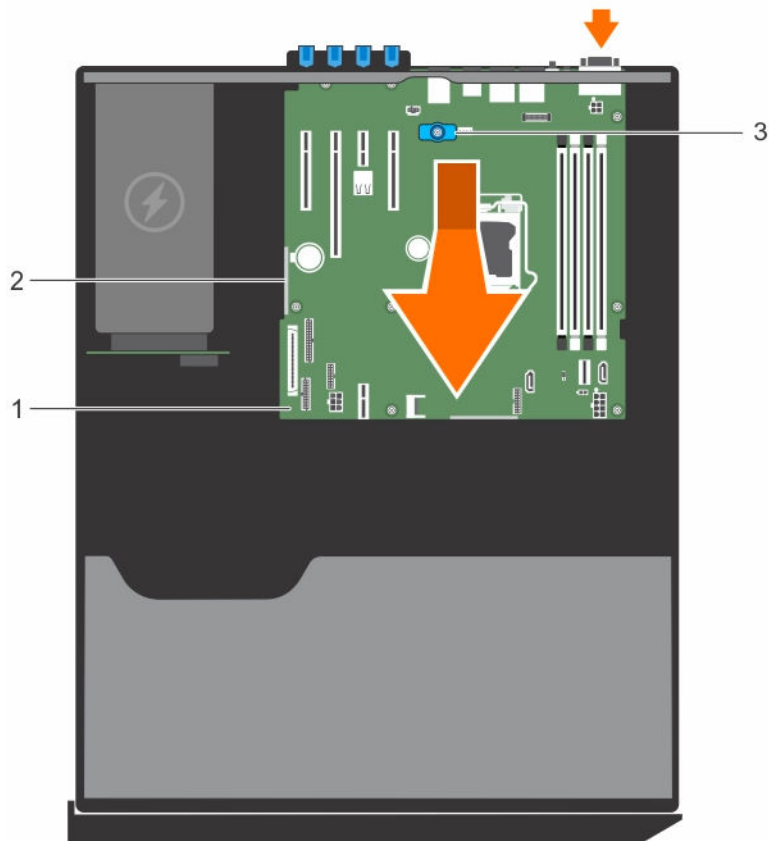

Figure 56. Removing and installing the screws on the system board

1. screw (8)



**Figure 57. Removing and installing the system board**

- |                               |                    |
|-------------------------------|--------------------|
| 1. system board               | 2. touch point (2) |
| 3. system board t-handle post |                    |

#### **Next steps**

1. Install the system board.
2. Follow the procedure listed in [After working inside your system](#).

#### **Related Links**

- [Removing the cooling shroud](#)
- [Removing memory modules](#)
- [Removing the internal cooling fan](#)
- [Removing an expansion card](#)
- [Removing the heat sink](#)
- [Removing the processor](#)
- [Removing the optional iDRAC port card](#)
- [Removing the optional internal dual SD module](#)

## Installing the system board

### Prerequisites

 **CAUTION:** Many repairs may only be done by a certified service technician. You should only perform troubleshooting and simple repairs as authorized in your product documentation, or as directed by the online or telephone service and support team. Damage due to servicing that is not authorized by Dell is not covered by your warranty. Read and follow the safety instructions that are shipped with your product.

 **NOTE:** This is a Field Replaceable Unit (FRU). Removal and installation procedures must be performed only by Dell certified service technicians.

 **CAUTION:** Do not lift the system board by holding a memory module, processor, or other components.

 **CAUTION:** Take care not to damage the system identification button while placing the system board into the chassis.

1. Ensure that you follow the [Safety instructions](#).
2. Follow the procedure listed in [Before working inside your system](#).
3. Keep the Phillips #2 screwdriver ready.

### Steps

1. Hold the system board by its edges, and orient it toward the back of the chassis.
2. Lower the system board into the chassis until the connectors at the back of the system board align with the slots on the back of the chassis.
3. Tighten the screws that secure the system board to the chassis.

### Next steps

1. If required, install the Trusted Platform Module (TPM). See, [Installing the Trusted Platform Module](#).
2. Reinstall the following components:
  - a. expansion cards
  - b. memory modules
  - c. heat sink and processor
  - d. cooling fan
  - e. cooling shroud
  - f. iDRAC port card, if removed
  - g. internal dual SD module, if removed
3. Reconnect all cables to the system board.

 **NOTE:** Ensure that the cables inside the system are routed through the cable routing latch.
4. Follow the procedure listed in [After working inside your system](#).
5. Import your new or existing iDRAC Enterprise license. For more information, see the Integrated Dell Remote Access Controller User's Guide, at [Dell.com/idracmanuals](http://Dell.com/idracmanuals).

 **NOTE:** If you are using Easy Restore, you do not have to import an existing iDRAC Enterprise license.
6. Ensure that you perform the following steps:
  - a. Use the Easy Restore feature to restore the service tag. See [Restoring the Service Tag by using the Easy Restore feature](#).

- b. If the service tag is not backed up in the backup flash device, enter the system service tag manually. See [Entering the system Service Tag by using System Setup](#).
- c. Update the BIOS and iDRAC versions.
- d. Re-enable the Trusted Platform Module (TPM). See [Initializing the TPM for BitLocker users](#) or [Initializing the TPM for TXT users](#).

#### Related Links

- [Installing an expansion card](#)
- [Installing memory modules](#)
- [Installing the heat sink](#)
- [Installing the processor](#)
- [Installing the internal cooling fan](#)
- [Installing the cooling shroud](#)
- [Installing the optional iDRAC port card](#)
- [Installing the optional internal dual SD module](#)

## Restoring the Service Tag by using the Easy Restore feature

The Easy Restore feature enables you to restore your system's Service Tag, license, UEFI configuration, and the system configuration data after replacing the system board. All data is automatically backed up in a backup flash device. If BIOS detects a new system board and the Service Tag in the backup flash device, BIOS prompts the user to restore the backup information.

1. Turn on the system.  
If BIOS detects a new system board, and if the Service Tag is present in the backup flash device, BIOS displays the Service Tag, the status of the license, and the **UEFI Diagnostics** version.
2. Perform one of the following steps:
  - Press **Y** to restore the Service Tag, license, and diagnostics information.
  - Press **N** to navigate to the Dell Lifecycle Controller based restore options.
  - Press F10 to restore data from a previously created **Hardware Server Profile**.

After the restore process is complete, BIOS prompts to restore the system configuration data.

3. Perform one of the following steps:
  - Press **Y** to restore the system configuration data.
  - Press **N** to use the default configuration settings.

After the restore process is complete, the system restarts.

## Entering the system Service Tag by using System Setup

If Easy Restore fails to restore the Service Tag, use System Setup to enter the Service Tag.

1. Turn on the system.
2. Press F2 to enter System Setup.
3. Click **Service Tag Settings**.
4. Enter the Service Tag.



**NOTE:** You can enter the Service Tag only when the **Service Tag** field is empty. Ensure that you enter the correct Service Tag. After the Service Tag is entered, it cannot be updated or changed.

5. Click **Ok**.
6. Import your new or existing iDRAC Enterprise license.

For more information, see the *Integrated Dell Remote Access Controller User's Guide* at [Dell.com/idracmanuals](http://Dell.com/idracmanuals).

## Trusted Platform Module

Trusted Platform Module (TPM) is a dedicated microprocessor designed to secure hardware by integrating cryptographic keys into devices. A software can use a Trusted Platform Module to authenticate hardware devices. As each TPM chip has a unique and secret RSA key burned in as it is produced, it can perform the platform authentication.

 **CAUTION:** Do not attempt to remove the Trusted Platform Module (TPM) from the system board. After the TPM is installed, it is cryptographically bound to that specific system board. Any attempt to remove an installed TPM breaks the cryptographic binding, and it cannot be re-installed or installed on another system board.

 **NOTE:** This is a Field Replaceable Unit (FRU). Removal and installation procedures must be performed only by Dell certified service technicians.

## Installing the Trusted Platform Module

### Prerequisites

 **CAUTION:** Many repairs may only be done by a certified service technician. You should only perform troubleshooting and simple repairs as authorized in your product documentation, or as directed by the online or telephone service and support team. Damage due to servicing that is not authorized by Dell is not covered by your warranty. Read and follow the safety instructions that came with the product.

 **NOTE:** This is a Field Replaceable Unit (FRU). Removal and installation procedures should be performed only by Dell certified service technicians.

1. Follow the safety guidelines listed in the Safety instructions section.
2. Follow the procedure listed in the Before working inside your system section.

### Steps

1. Locate the Trusted Platform Module (TPM) connector on the system board.
  -  **NOTE:** To locate the TPM connector on the system board, see the System board connectors section.
2. Align the edge connectors on the TPM with the slot on the TPM connector.
3. Insert the TPM into the TPM connector such that the plastic bolt aligns with the slot on the system board.
4. Press the plastic bolt until the bolt snaps into place.

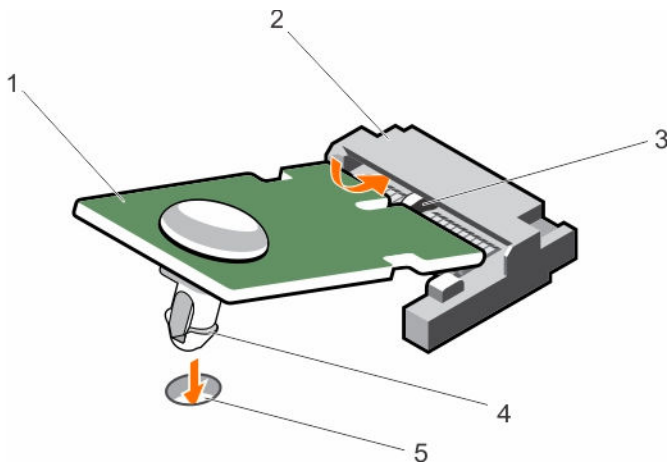

**Figure 58. Installing the TPM**

- |                              |                  |
|------------------------------|------------------|
| 1. TPM                       | 2. TPM connector |
| 3. slot on the TPM connector | 4. plastic bolt  |
| 5. slot on the system board  |                  |

#### Next steps

1. Install the system board.
2. Follow the procedure listed in the After working inside your system section.

#### Related Links

[Installing the system board](#)

### Initializing the TPM for BitLocker users

Initialize the TPM.

For more information about initializing the TPM, see <http://technet.microsoft.com/en-us/library/cc753140.aspx>.

The **TPM Status** changes to **Enabled, Activated**.

### Initializing the TPM for TXT users

1. While booting your system, press F2 to enter System Setup.
2. On the **System Setup Main Menu** screen, click **System BIOS** → **System Security Settings**.
3. From the **TPM Security** option, select **On with Pre-boot Measurements**.
4. From the **TPM Command** option, select **Activate**.
5. Save the settings.
6. Restart your system.
7. Enter **System Setup** again.
8. On the **System Setup Main Menu** screen, click **System BIOS** → **System Security Settings**.
9. From the **Intel TXT** option, select **On**.



# System top cover

Do not remove the system top cover unless you are converting the system from tower to rack mode.

## Removing the system top cover

### Prerequisites

**△ CAUTION:** Many repairs may only be done by a certified service technician. You should only perform troubleshooting and simple repairs as authorized in your product documentation, or as directed by the online or telephone service and support team. Damage due to servicing that is not authorized by Dell is not covered by your warranty. Read and follow the safety instructions that are shipped with your product.

1. Ensure that you follow the [Safety instructions](#).
2. Keep the Phillips #2 screwdriver ready.
3. Turn off the system, including any attached peripherals, and disconnect the system from the electrical outlet and peripherals.
4. Remove the system cover.

### Steps

1. Remove the screws that secure the top cover to the chassis.
2. Slide the cover toward the back of the system and lift it from the system.

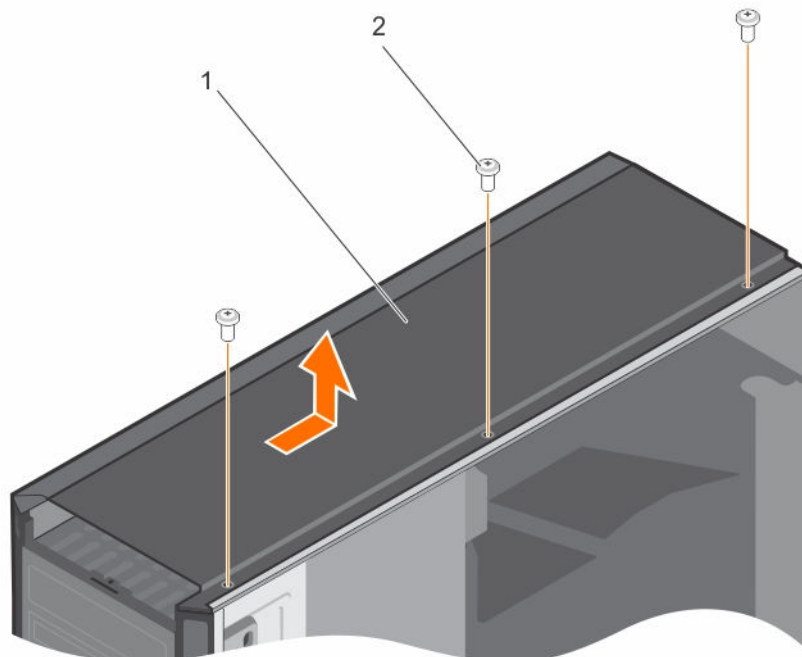

Figure 59. Removing the installing the system top cover

1. system top cover

2. screw (3)

### Related Links

[Removing the system cover](#)

[Installing the system top cover](#)

[Preparing a system for conversion from tower mode to rack mode](#)

## Installing the system top cover

### Prerequisites



**CAUTION:** Many repairs may only be done by a certified service technician. You should only perform troubleshooting and simple repairs as authorized in your product documentation, or as directed by the online or telephone service and support team. Damage due to servicing that is not authorized by Dell is not covered by your warranty. Read and follow the safety instructions that came with the product.

1. Ensure that you follow the [Safety instructions](#).
2. Keep the Phillips #2 screwdriver ready.

### Steps

1. Align the tabs under the top cover with the slots on the top of the chassis.
2. Slide the cover toward the front of the system until the screw holes on the cover align with the screw holes on the chassis.
3. Tighten the screws to secure the cover onto the chassis.

### Next steps

1. Install the system cover.
2. Reconnect the system to its electrical outlet and turn the system on, including any attached peripherals.

# Converting the system from tower mode to rack mode

Your system can be converted from tower mode to rack mode.

To convert your system from tower mode to rack mode, you require the tower-to-rack conversion kit, which contains the following items:

- Rack ears (left and right) with three screws each
- VGA module included with the control panel for rack mode
- A pair of rails (optional)

## Safety instructions

 **CAUTION:** Many repairs may only be done by a certified service technician. You should only perform troubleshooting and simple repairs as authorized in your product documentation, or as directed by the online or telephone service and support team. Damage due to servicing that is not authorized by Dell is not covered by your warranty. Read and follow the safety instructions that came with the product.

 **CAUTION:** Do not attempt to convert your system into a rack unless authorized by Dell. Only customers certified by Dell for tower to rack conversion can convert a tower system into a rack system.

 **NOTE:** For specific caution statements and procedures, see the rack installation documentation for your system at [Dell.com/poweredgemanuals](https://www.dell.com/poweredge/manuals). For complete safety and regulatory information, see the safety instructions that shipped with your system.

Observe the following precautions for stability and safety of the system in rack mode:

- Before installing your equipment in a rack, install the front and side rack stabilizers. Failure to install the stabilizers can cause the rack to tip over.
- Always load from bottom up, and load the heaviest items first.
- Do not overload the AC power supply branch circuit that provides power to the rack.

## Preparing a system for conversion from tower mode to rack mode

### Prerequisites

1. Ensure that you follow the [Safety instructions](#).
2. Keep the Phillips #2 screwdriver ready.
3. Turn off the system, including any attached peripherals, and disconnect the system from the electrical outlet and peripherals.

4. Place the system on a flat and stable surface.
5. If installed, remove the system feet or caster wheels.
6. Remove the system cover.

#### Steps

1. Remove the control panel assembly from the chassis.
2. Remove the control panel assembly cover.
3. Install the VGA module.
4. Install the control panel assembly cover for rack mode into the control panel assembly.
5. Remove the system top cover.
6. Install the control panel assembly for rack mode into the chassis.
7. To attach the rack ears, complete the following steps:
  - a. Align the screw holes on the right rack ear with the screw holes on the right side of the rack system.
  - b. Install the screws using a Phillips #2 screwdriver.

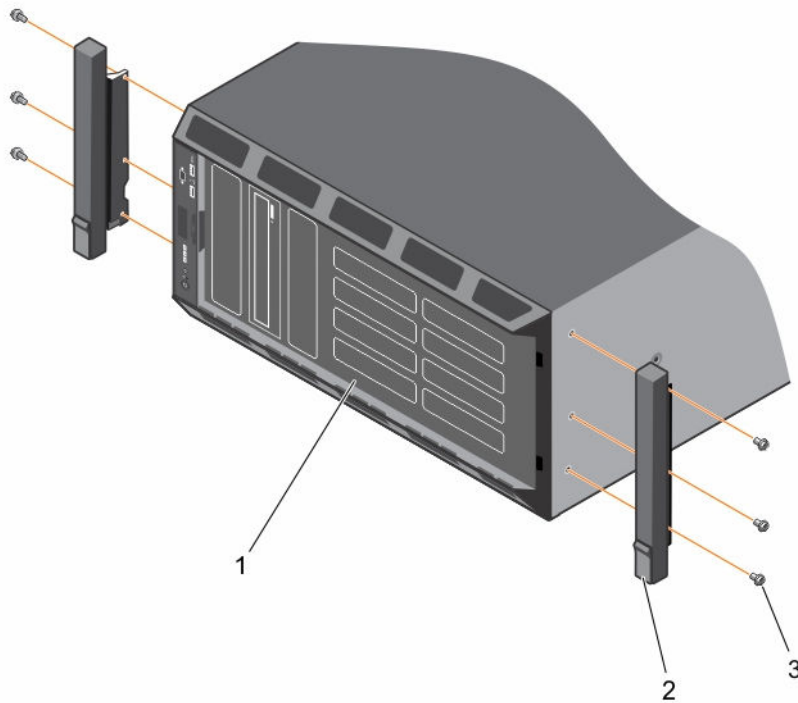

**Figure 60. Removing and installing the rack ears**

- |                                |                 |
|--------------------------------|-----------------|
| 1. front panel                 | 2. rack ear (2) |
| 3. screw for each rack ear (3) |                 |

#### Next steps

1. Install the system cover.
2. Install the system in a rack. For more information, see the system's Rack Installation Guide at [Dell.com/poweredgemanuals](http://Dell.com/poweredgemanuals).

## Related Links

[Removing the system feet](#)

[Removing caster wheels](#)

[Removing the system cover](#)

[Removing the control panel assembly](#)

[Removing the control panel assembly cover](#)

[Installing the optional VGA module](#)

[Installing the control panel assembly cover](#)

[Removing the system top cover](#)

[Installing the control panel assembly](#)

# Troubleshooting your system

## Safety first — for you and your system

 **CAUTION:** Many repairs may only be done by a certified service technician. You should only perform troubleshooting and simple repairs as authorized in your product documentation, or as directed by the online or telephone service and support team. Damage due to servicing that is not authorized by Dell is not covered by your warranty. Read and follow the safety instructions that are shipped with your product.

 **NOTE:** Solution validation was performed by using the factory shipped hardware configuration.

## Troubleshooting system startup failure

If you boot the system to the BIOS boot mode after installing an operating system from the UEFI Boot Manager, the system stops responding. To avoid this issue, you must boot to the same boot mode in which you installed the operating system.

For all other startup issues, note the system messages that appear on the screen.

## Troubleshooting external connections

Before troubleshooting any external devices, ensure that all external cables are securely attached to the external connectors on your system before troubleshooting any external devices.

## Troubleshooting the video subsystem

### Prerequisites

 **NOTE:** Ensure the **Local Server Video Enabled** option is selected in the iDRAC Graphical User Interface (GUI), under **Virtual Console**. If this option is not selected, local video is disabled.

### Steps

1. Check the cable connections (power and display) to the monitor.
2. Check the video interface cabling from the system to the monitor.
3. Run the appropriate diagnostic test.

If the tests run successfully, the problem is not related to video hardware.

### Next steps

If the tests fail, see the Getting help section.

# Troubleshooting a USB device

## Prerequisites



**NOTE:** Follow steps 1 to 5 to troubleshoot a USB keyboard or mouse. For other USB devices, go to step 6.

## Steps

1. Disconnect the keyboard and/or mouse cables from the system and reconnect them.
2. If the problem persists, connect the keyboard and/or mouse to another USB port on the system.
3. If the problem is resolved, restart the system, enter System Setup, and check if the non-functioning USB ports are enabled.
4. In **iDRAC Settings Utility**, ensure that **USB Management Port Mode** is configured as **Automatic** or **Standard OS Use**.
5. If the problem is not resolved, replace the keyboard and/or mouse with a known working keyboard or mouse.  
If the problem is not resolved, proceed to step 6 to troubleshoot other USB devices attached to the system.
6. Turn off all attached USB devices, and disconnect them from the system.
7. Restart the system.
8. If your keyboard is functioning, enter System Setup, verify that all USB ports are enabled on the **Integrated Devices** screen. If your keyboard is not functioning, use remote access to enable or disable the USB options.
9. If the system is not accessible, reset the NVRAM\_CLR jumper inside your system and restore the BIOS to the default settings. See the System board jumper setting section
10. In the **iDRAC Settings Utility**, ensure that **USB Management Port Mode** is configured as **Automatic** or **Standard OS Use**.
11. Reconnect and turn on each USB device one at a time.
12. If a USB device causes the same problem, turn off the device, replace the USB cable with a known good cable, and turn on the device.

## Next steps

If all troubleshooting fails, see the Getting help section.

# Troubleshooting iDRAC Direct (USB XML configuration)

For information about USB storage device and server configuration, see the Integrated Dell Remote Access Controller User's Guide at [Dell.com/idracmanuals](http://Dell.com/idracmanuals).

## Steps

1. Ensure that your USB storage device is connected to the front USB Management Port, identified by  icon.
2. Ensure that your USB storage device is configured with an NTFS or an FAT32 file system with only one partition.
3. Verify that the USB storage device is configured correctly. For more information about configuring the USB storage device, see the Integrated Dell Remote Access Controller User's Guide at [Dell.com/idracmanuals](http://Dell.com/idracmanuals).
4. In the **iDRAC Settings Utility**, ensure that **USB Management Port Mode** is configured as **Automatic** or **iDRAC Direct Only**.

5. Ensure that the **iDRAC Managed: USB XML Configuration** option is either **Enabled** or **Enabled only when the server has default credential settings**.
6. Remove and reinsert the USB storage device.
7. If import operation does not work, try with a different USB storage device.

#### Next steps

If all troubleshooting fails, see the Getting help section.

## Troubleshooting iDRAC Direct (Laptop connection)

For information about USB laptop connection and server configuration, see the *Integrated Dell Remote Access Controller User's Guide* at [Dell.com/idracmanuals](http://Dell.com/idracmanuals).

#### Steps

1. Ensure that your laptop is connected to the front USB Management Port, identified by  icon with a USB Type A/A cable.
2. On the **iDRAC Settings Utility** screen, ensure that **USB Management Port Mode** is configured as **Automatic** or **iDRAC Direct Only**.
3. If the laptop is running Windows operating system, ensure that the iDRAC Virtual USB NIC device driver is installed.
4. If the driver is installed, ensure that you are not connected to any network through WiFi or cabled ethernet, as iDRAC Direct uses a non-routable address.

#### Next steps

If all troubleshooting fails, see the Getting help section.

## Troubleshooting a serial I/O device

#### Steps

1. Turn off the system and any peripheral devices connected to the serial port.
2. Swap the serial interface cable with a known working cable, and turn on the system and the serial device.  
If the problem is resolved, replace the interface cable with a known working cable.
3. Turn off the system and the serial device, and swap the serial device with a compatible device.
4. Turn on the system and the serial device.

#### Next steps

If the problem persists, see the Getting help section.

## Troubleshooting a NIC

#### Steps

1. Run the appropriate diagnostic test. For more information, see the Using system diagnostics section for the available diagnostic tests.
2. Restart the system and check for any system messages pertaining to the NIC controller.
3. Check the appropriate indicator on the NIC connector:
  - If the link indicator does not glow, the cable connected might be disengaged.
  - If the activity indicator does not glow, the network driver files might be damaged or missing.



- Install or replace the drivers as necessary. For more information, see the NIC documentation.
- If the problem persists, use another connector on the switch or hub.
4. Ensure that the appropriate drivers are installed and the protocols are bound. For more information, see the NIC documentation.
  5. Enter System Setup and confirm that the NIC ports are enabled on the **Integrated Devices** screen.
  6. Ensure that all the NICs, hubs, and switches on the network are set to the same data transmission speed and duplex. For more information, see the documentation for each network device.
  7. Ensure that all network cables are of the proper type and do not exceed the maximum length.

#### Next steps

If the problem persists, see the Getting help section.

## Troubleshooting a wet system

#### Prerequisites

 **CAUTION: Many repairs may only be done by a certified service technician. You should only perform troubleshooting and simple repairs as authorized in your product documentation, or as directed by the online or telephone service and support team. Damage due to servicing that is not authorized by Dell is not covered by your warranty. Read and follow the safety instructions that are shipped with your product.**

#### Steps

1. Turn off the system and attached peripherals, and disconnect the system from the electrical outlet.
2. Remove the system cover.
3. Remove the following components (if installed) from the system:
  - power supply unit(s)
  - optical drive
  - hard drives
  - hard drive backplane
  - USB memory key
  - hard drive tray
  - cooling shroud
  - expansion card risers (if installed)
  - expansion cards
  - cooling fan assembly (if installed)
  - cooling fans
  - memory modules
  - processor(s) and heat sink(s)
  - system board
4. Let the system dry thoroughly for at least 24 hours.
5. Reinstall the components you removed in step 3 except the expansion cards.
6. Install the system cover.
7. Turn on the system and attached peripherals.  
If the problem persists, see the Getting help section.
8. If the system starts properly, shut down the system, and reinstall all the expansion cards that you removed.

9. Run the appropriate diagnostic test. For more information, see the Using system diagnostics section.

#### Next steps

If the tests fail, see the Getting help section.

## Troubleshooting a damaged system

#### Prerequisites

 **CAUTION:** Many repairs may only be done by a certified service technician. You should only perform troubleshooting and simple repairs as authorized in your product documentation, or as directed by the online or telephone service and support team. Damage due to servicing that is not authorized by Dell is not covered by your warranty. Read and follow the safety instructions that are shipped with your product.

#### Steps

1. Turn off the system and attached peripherals, and disconnect the system from the electrical outlet.
2. Remove the system cover.
3. Ensure that the following components are properly installed:
  - cooling shroud
  - expansion card risers (if installed)
  - expansion cards
  - power supply unit(s)
  - cooling fan assembly (if installed)
  - cooling fans
  - processor(s) and heat sink(s)
  - memory modules
  - hard drive carriers/cage
  - hard drive backplane
4. Ensure that all cables are properly connected.
5. Install the system cover.
6. Run the appropriate diagnostic test. For more information, see the Using system diagnostics section.

#### Next steps

If the problem persists, see the Getting help section.

## Troubleshooting the system battery

#### Prerequisites

 **CAUTION:** Many repairs may only be done by a certified service technician. You should only perform troubleshooting and simple repairs as authorized in your product documentation, or as directed by the online or telephone service and support team. Damage due to servicing that is not authorized by Dell is not covered by your warranty. Read and follow the safety instructions that are shipped with your product.

 **NOTE:** If the system is turned off for long periods of time (for weeks or months), the NVRAM may lose its system configuration information. This situation is caused by a defective battery.

 **NOTE:** Some software may cause the system time to speed up or slow down. If the system seems to operate normally except for the time set in System Setup, the problem may be caused by a software, rather than by a defective battery.

### Steps

1. Re-enter the time and date in System Setup.
2. Turn off the system, and disconnect it from the electrical outlet for at least an hour.
3. Reconnect the system to the electrical outlet, and turn on the system.
4. Enter System Setup.

If the date and time displayed in System Setup are not correct, check the System Error Log (SEL) for system battery messages.

### Next steps

If the problem persists, see the Getting help section.

## Troubleshooting power supply units

 **CAUTION:** Many repairs may only be done by a certified service technician. You should only perform troubleshooting and simple repairs as authorized in your product documentation, or as directed by the online or telephone service and support team. Damage due to servicing that is not authorized by Dell is not covered by your warranty. Read and follow the safety instructions that are shipped with your product.

### Troubleshooting power source problems

1. Press the power button to ensure that your system is turned on. If the power indicator does not glow when the power button is pressed, press the power button firmly.
2. Plug in another working power supply unit to ensure that the system board is not faulty.
3. Ensure that no loose connections exist.  
For example, loose power cables.
4. Ensure that the power source meets applicable standards.
5. Ensure that there are no short circuits.
6. Have a qualified electrician check the line voltage to ensure that it meets the needed specifications.

### Power supply unit problems

1. Ensure that no loose connections exist.  
For example, loose power cables.
2. Ensure that the power supply handle or LED indicates that the power supply is working properly.  
For more information about power supply indicators, see the Power indicator codes section.
3. If you have recently upgraded your system, ensure that the power supply unit (PSU) has enough power to support the new system.
4. If you have a redundant power supply configuration, ensure that both the PSUs are of the same type and wattage.  
You may have to upgrade to a higher wattage PSU.
5. Ensure that you use only PSUs with the Extended Power Performance (EPP) label on the back.
6. Reseat the PSU.



**NOTE:** After installing a PSU, allow several seconds for the system to recognize the PSU and determine if it is working properly.

If the problem persists, see the Getting help section.

## Troubleshooting cooling problems

 **CAUTION:** Many repairs may only be done by a certified service technician. You should only perform troubleshooting and simple repairs as authorized in your product documentation, or as directed by the online or telephone service and support team. Damage due to servicing that is not authorized by Dell is not covered by your warranty. Read and follow the safety instructions that are shipped with your product.

Ensure that the following conditions exist:

- System cover, cooling shroud, EMI filler panel, or back-filler bracket is not removed.
- Ambient temperature is not higher than the specified ambient temperature.
- External airflow is not obstructed.
- A cooling fan is not removed or has not failed.
- The expansion card installation guidelines have been followed.

Additional cooling can be added by one of the following methods:

From the iDRAC Web GUI:

1. Click **Hardware** → **Fans** → **Setup**.
2. From the **Fan Speed Offset** drop-down list, select the cooling level needed or set the minimum fan speed to a custom value.

From F2 System Setup:

1. Select **iDRAC Settings** → **Thermal**, and set a higher fan speed from the fan speed offset or minimum fan speed.

From RACADM commands:

1. Run the command `racadm help system.thermalsettings`

For more information, see the Integrated Dell Remote Access Controller User's Guide at [Dell.com/idracmanuals](http://Dell.com/idracmanuals).

## Troubleshooting cooling fans

### Prerequisites

 **CAUTION:** Many repairs may only be done by a certified service technician. You should only perform troubleshooting and simple repairs as authorized in your product documentation, or as directed by the online or telephone service and support team. Damage due to servicing that is not authorized by Dell is not covered by your warranty. Read and follow the safety instructions that are shipped with your product.

 **NOTE:** The fan number is referenced by the systems management software. In the event of a problem with a particular fan, you can easily identify and replace it by noting down the fan numbers on the cooling fan assembly.

1. Follow the safety guidelines listed in safety instructions section.
2. Follow the procedure listed in the Before working inside your system section.

### Steps

1. Remove the system cover.
2. Reseat the fan or the fan's power cable.
3. Install the system cover.
4. Restart the system.

### Next steps

If the problem persists, see the Getting help section.

## Troubleshooting system memory

### Prerequisites



**CAUTION:** Many repairs may only be done by a certified service technician. You should only perform troubleshooting and simple repairs as authorized in your product documentation, or as directed by the online or telephone service and support team. Damage due to servicing that is not authorized by Dell is not covered by your warranty. Read and follow the safety instructions that are shipped with your product.

### Steps

1. If the system is operational, run the appropriate system diagnostic test. See the Using system diagnostics section for the available diagnostic tests.  
If the diagnostic tests indicate a fault, follow the corrective actions provided by the diagnostic tests.
2. If the system is not operational, turn off the system and attached peripherals, and unplug the system from the power source. Wait at least for 10 seconds, and then reconnect the system to the power source.
3. Turn on the system and attached peripherals, and note the messages on the screen.  
If an error message is displayed indicating a fault with a specific memory module, go to step 12.
4. Enter System Setup, and check the system memory setting. Make any changes to the memory settings, if needed.  
If the memory settings match the installed memory but the problem still persists, go to step 12.
5. Turn off the system and attached peripherals, and disconnect the system from the electrical outlet.
6. Remove the system cover.
7. Check the memory channels and ensure that they are populated correctly.  
 **NOTE:** See the system event log or system messages for the location of the failed memory module. Reinstall the memory device.
8. Reseat the memory modules in their sockets.
9. Install the system cover.
10. Enter System Setup and check the system memory setting.  
If the problem is not resolved, proceed with step 11.
11. Remove the system cover.
12. If a diagnostic test or error message indicates a specific memory module as faulty, swap or replace the module with a known working memory module.
13. To troubleshoot an unspecified faulty memory module, replace the memory module in the first DIMM socket with a module of the same type and capacity.  
If an error message is displayed on the screen, this may indicate a problem with the installed DIMM type(s), incorrect DIMM installation, or defective DIMM(s). Follow the on-screen instructions to resolve the problem.

14. Install the system cover.
15. As the system boots, observe any error message that is displayed and the diagnostic indicators on the front of the system.
16. If the memory problem persists, repeat step 12 through step 15 for each memory module installed.

#### Next steps

If the problem persists, see the Getting help section.

## Troubleshooting an internal USB key

#### Prerequisites

 **CAUTION:** Many repairs may only be done by a certified service technician. You should only perform troubleshooting and simple repairs as authorized in your product documentation, or as directed by the online or telephone service and support team. Damage due to servicing that is not authorized by Dell is not covered by your warranty. Read and follow the safety instructions that are shipped with your product.

#### Steps

1. Enter System Setup and ensure that the **USB key port** is enabled on the **Integrated Devices** screen.
2. Turn off the system and attached peripherals, and disconnect the system from the electrical outlet.
3. Remove the system cover.
4. Locate the USB key and reseal it.
5. Install the system cover.
6. Turn on the system and attached peripherals, and check if the USB key is functioning.
7. If the problem is not resolved, repeat step 2 and step 3.
8. Insert a known working USB key.
9. Install the system cover.

#### Next steps

If the problem persists, see the Getting help section.

## Troubleshooting an SD card

#### Prerequisites

 **CAUTION:** Many repairs may only be done by a certified service technician. You should only perform troubleshooting and simple repairs as authorized in your product documentation, or as directed by the online or telephone service and support team. Damage due to servicing that is not authorized by Dell is not covered by your warranty. Read and follow the safety instructions that are shipped with your product.

 **NOTE:** Certain SD cards have a physical write-protect switch on the card. If the write-protect switch is turned on, the SD card is not writable.

#### Steps

1. Enter System Setup, and ensure that the **Internal SD Card Port** is enabled.
2. Turn off the system, including any attached peripherals, and disconnect the system from the electrical outlet.
3. Remove the system cover.

 **NOTE:** When an SD card failure occurs, the internal dual SD module controller notifies the system. On the next restart, the system displays a message indicating the failure. If redundancy is enabled at the time of SD card failure, a critical alert will be logged and chassis health will degrade.

4. Replace the failed SD card with a new SD card.
5. Install the system cover.
6. Reconnect the system to its electrical outlet and turn on the system, including any attached peripherals.
7. Enter System Setup, and ensure that the **Internal SD Card Port** and **Internal SD Card Redundancy** modes are set to the needed modes.  
Verify that the correct SD slot is set as **Primary SD Card**.
8. Check if the SD card is functioning properly.
9. If the **Internal SD Card Redundancy** option is set to **Enabled** at the time of the SD card failure, the system prompts you to perform a rebuild.

 **NOTE:** The rebuild is always sourced from the primary SD card to the secondary SD card.

## Troubleshooting an optical drive

### Prerequisites

 **CAUTION:** Many repairs may only be done by a certified service technician. You should only perform troubleshooting and simple repairs as authorized in your product documentation, or as directed by the online or telephone service and support team. Damage due to servicing that is not authorized by Dell is not covered by your warranty. Read and follow the safety instructions that are shipped with your product.

### Steps

1. Try using a different CD or DVD.
2. If the problem is not resolved, enter System Setup and ensure that the integrated SATA controller and the drive's SATA port are enabled.
3. Run the appropriate diagnostic test.
4. Turn off the system and attached peripherals, and disconnect the system from the electrical outlet.
5. If installed, remove the bezel.
6. Remove the system cover.
7. Ensure that the interface cable is securely connected to the optical drive and to the controller.
8. Ensure that a power cable is properly connected to the drive.
9. Install the system cover.

### Next steps

If the problem persists, see the Getting help section.

# Troubleshooting a tape backup unit

## Prerequisites

 **CAUTION:** Many repairs may only be done by a certified service technician. You should only perform troubleshooting and simple repairs as authorized in your product documentation, or as directed by the online or telephone service and support team. Damage due to servicing that is not authorized by Dell is not covered by your warranty. Read and follow the safety instructions that are shipped with your product.

## Steps

1. Use a different tape cartridge.
2. Ensure that the device drivers for the tape backup unit are installed and are configured correctly. See your tape drive documentation for more information about device drivers.
3. Reinstall the tape-backup software as instructed in the tape-backup software documentation.
4. Ensure that the interface cable of the tape drive is connected to the external port on the controller card.
5. Perform the following steps to ensure that the controller card is properly installed:
  - a. Turn off the system and attached peripherals, and disconnect the system from the electrical outlet.
  - b. Remove the system cover.
  - c. Reseat the controller card in the expansion card slot.
  - d. Install the system cover.
  - e. Turn on the system and attached peripherals.
6. Run the appropriate diagnostic test. For more information, see the Using system diagnostics.

## Next steps

If you cannot resolve the problem, see the Getting help section.

# Troubleshooting a hard drive

## Prerequisites

 **CAUTION:** This troubleshooting procedure can erase data stored on the hard drive. Before you proceed, back up all files on the hard drive.

 **CAUTION:** Many repairs may only be done by a certified service technician. You should only perform troubleshooting and simple repairs as authorized in your product documentation, or as directed by the online or telephone service and support team. Damage due to servicing that is not authorized by Dell is not covered by your warranty. Read and follow the safety instructions that are shipped with your product.

## Steps

1. Run the appropriate diagnostic test. See the Using system diagnostics section.  
Depending on the results of the diagnostics test, proceed as needed through the following steps.
2. If your system has a RAID controller and your hard drives are configured in a RAID array, perform the following steps:
  - a. Restart the system and press F10 during system startup to run the Dell Lifecycle Controller, and then run the Hardware Configuration wizard to check the RAID configuration.  
See the Dell Lifecycle Controller documentation or online help for information about RAID configuration.



- b. Ensure that the hard drives are configured correctly for the RAID array.
  - c. Take the hard drive offline and reseal the drive.
  - d. Exit the configuration utility and allow the system to boot to the operating system.
3. Ensure that the needed device drivers for your controller card are installed and are configured correctly. See the operating system documentation for more information.
  4. Restart the system and enter the System Setup.
  5. Verify that the controller is enabled and the drives are displayed in the System Setup.

#### Next steps

If the problem persists, see the Getting help section.

## Troubleshooting a storage controller

 **CAUTION:** Many repairs may only be done by a certified service technician. You should only perform troubleshooting and simple repairs as authorized in your product documentation, or as directed by the online or telephone service and support team. Damage due to servicing that is not authorized by Dell is not covered by your warranty. Read and follow the safety instructions that are shipped with your product.

 **NOTE:** When troubleshooting a SAS or PERC controller, see the documentation for your operating system and the controller.

1. Run the appropriate diagnostic test. See the Using system diagnostics section.
2. Turn off the system and attached peripherals, and disconnect the system from the electrical outlet.
3. Remove the system cover.
4. Verify that the installed expansion cards are compliant with the expansion card installation guidelines.
5. Ensure that each expansion card is firmly seated in its connector.
6. Install the system cover.
7. Reconnect the system to the electrical outlet, and turn on the system and attached peripherals.
8. If the problem is not resolved, turn off the system and attached peripherals, and disconnect the system from the electrical outlet.
9. Remove the system cover.
10. Remove all expansion cards installed in the system.
11. Install the system cover.
12. Reconnect the system to the electrical outlet, and turn on the system and attached peripherals.
13. Run the appropriate diagnostic test. See the Using system diagnostics section. If the tests fail, see the Getting help section.
14. For each expansion card you removed in step 10, perform the following steps:
  - a. Turn off the system and attached peripherals, and disconnect the system from the electrical outlet.
  - b. Remove the system cover.
  - c. Reinstall one of the expansion cards.
  - d. Install the system cover.
  - e. Run the appropriate diagnostic test. See the Using system diagnostics section.

If the problem persists, see the Getting help section.

# Troubleshooting expansion cards

## Prerequisites

 **CAUTION:** Many repairs may only be done by a certified service technician. You should only perform troubleshooting and simple repairs as authorized in your product documentation, or as directed by the online or telephone service and support team. Damage due to servicing that is not authorized by Dell is not covered by your warranty. Read and follow the safety instructions that are shipped with your product.

 **NOTE:** When troubleshooting an expansion card, you also have to see the documentation for your operating system and the expansion card.

## Steps

1. Run the appropriate diagnostic test. See the Using system diagnostics section.
2. Turn off the system and attached peripherals, and disconnect the system from the electrical outlet.
3. Remove the system cover.
4. Ensure that each expansion card is firmly seated in its connector.
5. Install the system cover.
6. Turn on the system and attached peripherals.
7. If the problem is not resolved, turn off the system and attached peripherals, and disconnect the system from the electrical outlet.
8. Remove the system cover.
9. Remove all expansion cards installed in the system.
10. Install the system cover.
11. Run the appropriate diagnostic test. See the Using system diagnostics section.  
If the tests fail, see the Getting help section.
12. For each expansion card you removed in step 8, perform the following steps:
  - a. Turn off the system and attached peripherals, and disconnect the system from the electrical outlet.
  - b. Remove the system cover.
  - c. Reinstall one of the expansion cards.
  - d. Install the system cover.
  - e. Run the appropriate diagnostic test. See the Using system diagnostics section.

## Next steps

If the problem persists, see the Getting help section.

# Troubleshooting processors

## Prerequisites

 **CAUTION:** Many repairs may only be done by a certified service technician. You should only perform troubleshooting and simple repairs as authorized in your product documentation, or as directed by the online or telephone service and support team. Damage due to servicing that is not authorized by Dell is not covered by your warranty. Read and follow the safety instructions that are shipped with your product.

**Steps**

1. Run the appropriate diagnostics test. See the Using system diagnostics section.
2. Turn off the system and attached peripherals, and disconnect the system from the electrical outlet.
3. Remove the system cover.
4. Ensure that the processor and heat sink are properly installed.
5. Install the system cover.
6. Run the appropriate diagnostic test. See the Using system diagnostics section.
7. If the problem persists, see the Getting help section.

# Using system diagnostics

If you experience a problem with your system, run the system diagnostics before contacting Dell for technical assistance. The purpose of running system diagnostics is to test your system hardware without requiring additional equipment or risking data loss. If you are unable to fix the problem yourself, service and support personnel can use the diagnostics results to help you solve the problem.

## Dell Embedded System Diagnostics

 **NOTE:** The Dell Embedded System Diagnostics is also known as Enhanced Pre-boot System Assessment (ePSA) diagnostics.

The Embedded System Diagnostics provides a set of options for particular device groups or devices allowing you to:

- Run tests automatically or in an interactive mode
- Repeat tests
- Display or save test results
- Run thorough tests to introduce additional test options to provide extra information about the failed device(s)
- View status messages that inform you if tests are completed successfully
- View error messages that inform you of problems encountered during testing

### When to use the Embedded System Diagnostics

Run the Embedded System Diagnostics (ePSA) if your system does not boot.

### Running the Embedded System Diagnostics from Boot Manager

#### Prerequisites

Run the Embedded System Diagnostics (ePSA) if your system does not boot.

#### Steps

1. When the system is booting, press F11.
2. Use the up arrow and down arrow keys to select **System Utilities** → **Launch Diagnostics**.  
The **ePSA Pre-boot System Assessment** window is displayed, listing all devices detected in the system. The diagnostics starts executing the tests on all the detected devices.

### Running the Embedded System Diagnostics from the Dell Lifecycle Controller

1. As the system boots, press F11.
2. Select **Hardware Diagnostics** → **Run Hardware Diagnostics**.

The **ePSA Pre-boot System Assessment** window is displayed, listing all devices detected in the system. The diagnostics starts executing the tests on all the detected devices.

## System diagnostics controls

Menu	Description
Configuration	Displays the configuration and status of all detected devices.
Results	Displays the results of all tests that are executed.
System health	Provides the current overview of the system performance.
Event log	Displays a time-stamped log of the results of all tests run on the system. This is displayed if at least one event description is recorded.

# Jumpers and connectors

## System board jumpers and connectors

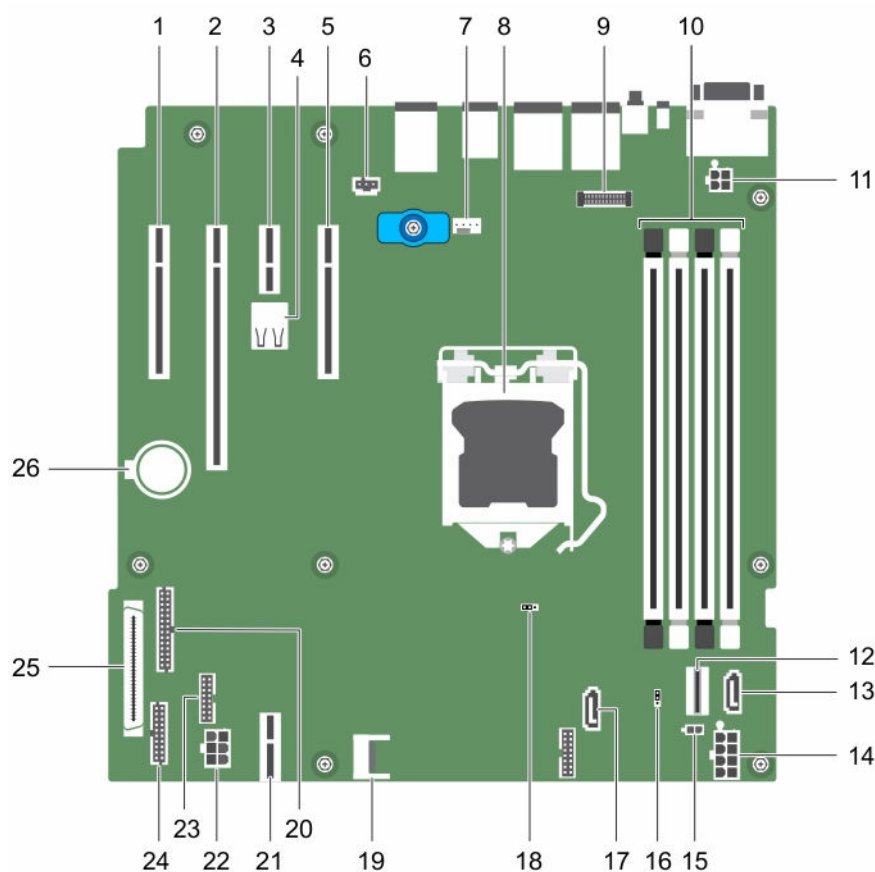



Figure 61. System board jumpers and connectors

Table 17. System board jumpers and connectors

Item	Connector	Description
1	Slot 1 PCIE_G3_X4 CPU	PCIe card connector 1
2	Slot 2 PCIE_G3_X8 CPU	PCIe card connector 2





<b>Item</b>	<b>Connector</b>	<b>Description</b>
3	Slot 3 PCIE_G3_X1 PCH	PCIe card connector 3
4	INT_USB_3.0	Internal USB
5	Slot 4 PCIE_G3_X4 PCH	PCIe card connector 4
6	J_INTRU2	Intrusion connector
7	MB / Fan1	Cooling fan connector
8	CPU	Processor
9	J_AMEA1	iDRAC ports card connector
10	A1, A2, A3, A4	Memory module sockets
11	CPU_PWR	CPU power connector P2
12	SATA 0–3/SATAe	Mini SAS connector
13	SATA_ODD/SSD	Optical disk drive connector
14	SYS_PWR	System power P1
15	PWR_EVNT	Power event
16	PWRD_EN	Password jumpers
17	J_SATA_2	SATA connector 2
18	NVRAM_CLR	NVRAM password jumper
19	TPM	Trusted platform module connector
20	PIB_CONN	PIB connector
21	IDSMD	Internal dual SD module connector
22	HDD/ODD_PWR	Hard drive power connector
23	BP_SIG	Backplane signal connector
24	FP_USB	Front panel USB connector
25	CTRL_PNL	Control panel
26	BATTERY	System battery

## System board jumper settings

 **CAUTION:** Many repairs may only be done by a certified service technician. You should only perform troubleshooting and simple repairs as authorized in your product documentation, or as directed by the online or telephone service and support team. Damage due to servicing that is not authorized by Dell is not covered by your warranty. Read and follow the safety instructions that came with the product.

For information about resetting the password jumper to disable a password, see [Disabling a forgotten password](#).

**Table 18. System Board Jumper settings**

Jumper	Setting	Description
PWRD_EN	 1 2 3 (default)	The password feature is enabled (pins 1–2).
	 1 2 3	The password feature is disabled (pins 2–3).
NVRAM_CLR	 1 2 3 (default)	The configuration settings are retained at system boot (pins 2–3).
	 1 2 3	The configuration settings are cleared at the next system boot. (pins 1–2).

## Disabling a forgotten password

The system's software security features include a system password and a setup password. The password jumper enables these password features or disables them and clears any password(s) currently in use.

### Prerequisites

 **CAUTION:** Many repairs may only be done by a certified service technician. You should only perform troubleshooting and simple repairs as authorized in your product documentation, or as directed by the online or telephone service and support team. Damage due to servicing that is not authorized by Dell is not covered by your warranty. Read and follow the safety instructions that are shipped with your product.

### Steps

1. Turn off the system, including any attached peripherals, and disconnect the system from the electrical outlet.
2. Remove the system cover.
3. Move the jumper on the system board jumper from pins 2 and 3 to pins 1 and 2.
4. Install the system cover.

The existing passwords are not disabled (erased) until the system boots with the jumper on pins 1 and 2. However, before you assign a new system and/or setup password, you must move the jumper back to pins 2 and 3.

 **NOTE:** If you assign a new system and/or setup password with the jumper on pins 1 and 2, the system disables the new password(s) the next time it boots.

5. Reconnect the system to its electrical outlet and turn on the system, including any attached peripherals.
6. Turn off the system, including any attached peripherals, and disconnect the system from the electrical outlet.
7. Remove the system cover.
8. Move the jumper on the system board jumper from pins 1 and 2 to pins 2 and 3.
9. Install the system cover.
10. Reconnect the system to its electrical outlet and turn on the system, including any attached peripherals.
11. Assign a new system or setup password.



# Technical specifications

## Dimensions and weight

Physical	Dimensions
Height	443.3 mm (17.45 inch) with feet
	430.3 mm (16.94 inch) without feet
Width	304.5 mm (11.98 inch) with feet opened
	218 mm (8.58 inch) with feet closed
Depth	561.8 mm (22.12 inch) without bezel
	578.2 mm (22.76 inch) with bezel
Weight (maximum)	26.02 kg (57.32 lb)

## Processor specifications

Processor	Specification
Type	One Intel E3-1200 V5 series

## Expansion bus specifications



PCI Express expansion slots	Specification
Slot 1	One full-height, half-length x8 PCIe Gen3 card slot connected to processor
Slot 2	One full-height, half-length x16 PCIe Gen3 card slot connected to processor
Slot 3	One full-height, half-length x1 PCIe Gen3 card slot connected to Platform Controller Hub (PCH)
Slot 4	One full-height, half-length x8 PCIe Gen3 card slot connected to PCH

## Memory specifications

Memory	Specification
Architecture	1600 MT/s, 1866 MT/s, or 2133 MT/s DDR4 Unbuffered DIMMs

Memory	Specification
	Support for advanced ECC or memory optimized operation
Memory module sockets	Four 288-pin sockets
Memory module capacities (UDIMM)	4 GB (single-rank), 8 GB (single- and dual-rank), 16 GB (single- and dual-rank)
Minimum RAM	4 GB
Maximum RAM	64 GB



## Power specifications

Power supply unit	Specification
Power rating per hot swappable power supply unit (PSU)	495 W (Platinum) AC (100–240 V, 50/60 Hz, 6.5 A–3 A)
Power rating per cabled PSU	350 W (Bronze) AC (100–240 V, 50/60 Hz, 5.5 A–3 A)
Heat dissipation	 <b>NOTE:</b> Heat dissipation is calculated by using the power supply unit wattage rating.  1357 BTU/hr maximum (350 W PSU) 1908 BTU/hr maximum (495 W PSU)
Voltage	 <b>NOTE:</b> This system is also designed to be connected to IT power systems with a phase-to-phase voltage not exceeding 230 V.  100–240 V AC, autoranging, 50/60 Hz



## Storage controller specifications

Storage controller	Specification
Storage controller type	PERC H730, PERC H330, PERC H830, PERC S130.   <b>NOTE:</b> Your system supports software RAID S130 and a PERC card. For more information on software RAID, see the Dell PowerEdge RAID Controller (PERC) documentation at <a href="https://www.dell.com/storagecontrollermanuals">Dell.com/storagecontrollermanuals</a> .

## Drive specifications

Drives	Specification
Eight hard drive systems	Up to eight 3.5-inch hot swappable SATA, or nearline SAS hard drives  <b>NOTE:</b> 2.5-inch hard drives in 3.5-inch carriers are supported for SAS, and SATA SSD hard drives
Four hard drive systems	Up to four 3.5-inch hot swappable SATA, or nearline SAS hard drives  <b>NOTE:</b> 2.5-inch hard drives in 3.5-inch carriers are supported for SAS, and SATA SSD hard drives
Optical drive	One optional SATA DVD-ROM drive or DVD+/-RW drive
Tape drive	Up to two optional 5.25-inch tape drives

## Connectors specifications

Back connectors	Specification
NIC	Two 10/100/1000 Mbps
Serial	DB-9 Serial Port connector
USB	Six Hi-Speed USB Host (four USB 2.0 and two USB 3.0)
Video	15-pin VGA
iDRAC8	One optional 1 GbE Ethernet
SD vFlash	One optional SD vFlash memory card
Front connectors	Specification
USB	Two Hi-Speed USB Host (One USB 2.0 and one USB 3.0)
Video	15-pin VGA  <b>NOTE:</b> The front VGA port is available only with the rack configuration.
Internal connectors	Specification
USB	One 9-pin, USB 3.0-compliant
Internal Dual SD Module	Two optional flash memory card slots with the internal SD module  <b>NOTE:</b> One card slot is dedicated for redundancy.

## Video specifications

Video	Specification
Video type	Integrated Matrox G200
Video memory	16 MB shared

## Expanded operating temperature

 **NOTE:** When operating in the expanded temperature range, system performance may be impacted.

 **NOTE:** When operating in the expanded temperature range, ambient temperature warnings may be reported on the LCD and in the System Event Log.

Expanded operating temperature	Specifications
--------------------------------	----------------

Continuous operation	5°C to 40°C at 5% to 85% RH with 29°C dew point.
----------------------	--

 **NOTE:** Outside the standard operating temperature (10°C to 35°C), the system can operate continuously down to 5°C or as high as 40°C.

For temperatures between 35°C and 40°C, de-rate maximum allowable temperature by 1°C per 175 m above 950 m (1°F per 319 ft).

≤ 1% of annual operating hours	–5°C to 45°C at 5% to 90% RH with 29°C dew point.
--------------------------------	---

 **NOTE:** Outside the standard operating temperature (10°C to 35°C), the system can operate down to –5°C or up to 45°C for a maximum of 1% of its annual operating hours.

For temperatures between 40°C and 45°C, de-rate maximum allowable temperature by 1°C per 125 m above 950 m (1°F per 228 ft).

### Expanded Operating Temperature Restrictions

- The operating temperature specified is for a maximum altitude of 3048 m (10,000 ft).
- Non-redundant power supply units are not supported.
- Cabled power supply units are not supported.
- Non Dell qualified peripheral cards and/or peripheral cards greater than 25 W are not supported.
- Internal Tape backup drive (TBU) is not supported.
- Do not perform a cold startup below 5°C.
- Enable processor performance degrade.

## Environmental specifications

 **NOTE:** For additional information about environmental measurements for specific system configurations, see [Dell.com/environmental\\_datasheets](https://www.dell.com/environmental_datasheets).

### Temperature Specifications

<b>Storage</b>	–40°C to 65°C (–40°F to 149°F)
<b>Continuous operation (for altitude less than 950 m or 3117 ft)</b>	10°C to 35°C (50°F to 95°F) with no direct sunlight on the equipment.
<b>Fresh air</b>	For information on fresh air, see Expanded Operating Temperature section.
<b>Maximum temperature gradient (operating and storage)</b>	20°C/h (36°F/h)

### Relative humidity Specifications

<b>Storage</b>	5% to 95% RH with 33°C (91°F) maximum dew point. Atmosphere must be non-condensing at all times.
<b>Operating</b>	10% to 80% Relative Humidity with 29°C (84.2°F) maximum dew point.

### Maximum vibration Specifications

<b>Operating</b>	0.26 G <sub>rms</sub> at 5 Hz to 350 Hz (all operation orientations).
<b>Storage</b>	1.88 G <sub>rms</sub> at 10 Hz to 500 Hz for 15 min (all six sides tested).

### Maximum shock Specifications

<b>Operating</b>	Six consecutively executed shock pulses in the positive and negative x, y, and z axes of 40 G for up to 2.3 ms.
<b>Storage</b>	Six consecutively executed shock pulses in the positive and negative x, y, and z axes (one pulse on each side of the system) of 71 G for up to 2 ms.

### Maximum altitude Specifications

<b>Operating</b>	3048 m (10,000 ft).
<b>Storage</b>	12,000 m (39,370 ft).

## Operating temperature de-rating

## Specifications

Up to 35 °C (95 °F)	Maximum temperature is reduced by 1°C/300 m (1°F/547 ft) above 950 m (3,117 ft)
35 °C to 40 °C (95 °F to 104 °F)	Maximum temperature is reduced by 1°C/175 m (1°F/319 ft) above 950 m (3,117 ft).
40 °C to 45 °C (104 °F to 113 °F)	Maximum temperature is reduced by 1°C/125 m (1°F/228 ft) above 950 m (3,117 ft).

The following section defines the limits to help avoid IT equipment damage and/or failure from particulates and gaseous contamination. If the levels of particulates or gaseous pollution are beyond the specified limits and cause equipment damage or failure, you may need to rectify the environmental conditions. Remediation of environmental conditions is the responsibility of the customer.

## Particulate contamination

## Specifications

### Air filtration

Data center air filtration as defined by ISO Class 8 per ISO 14644-1 with a 95% upper confidence limit.

 **NOTE:** Applies to data center environments only. Air filtration requirements do not apply to IT equipment designed to be used outside a data center, in environments such as an office or factory floor.

 **NOTE:** Air entering the data center must have MERV11 or MERV13 filtration.

### Conductive dust

Air must be free of conductive dust, zinc whiskers, or other conductive particles.

 **NOTE:** Applies to data center and non-data center environments.

### Corrosive dust

- Air must be free of corrosive dust.
- Residual dust present in the air must have a deliquescent point less than 60% relative humidity.

 **NOTE:** Applies to data center and non-data center environments.

## Gaseous contamination

## Specifications

### Copper coupon corrosion rate

<300 Å/month per Class G1 as defined by ANSI/ISA71.04-1985.

### Silver coupon corrosion rate

<200 Å/month as defined by AHSRAE TC9.9.

 **NOTE:** Maximum corrosive contaminant levels measured at  $\leq 50\%$  relative humidity.

# Getting help

## Contacting Dell

Dell provides several online and telephone-based support and service options. If you do not have an active internet connection, you can find contact information about your purchase invoice, packing slip, bill, or Dell product catalog. Availability varies by country and product, and some services may not be available in your area. To contact Dell for sales, technical assistance, or customer-service issues:

1. Go to **Dell.com/support**.
2. Select your country from the drop-down menu on the lower right corner of the page.
3. For customized support:
  - a. Enter your system Service Tag in the **Enter your Service Tag** field.
  - b. Click **Submit**.  
The support page that lists the various support categories is displayed.
4. For general support:
  - a. Select your product category.
  - b. Select your product segment.
  - c. Select your product.  
The support page that lists the various support categories is displayed.
5. For contact details of Dell Global Technical Support:
  - a. Click [Global Technical Support](#).
  - b. The **Contact Technical Support** page is displayed with details to call, chat, or e-mail the Dell Global Technical Support team.

## Locating Service Tag of your system

Your system is identified by a unique Express Service Code and Service Tag number. The Express Service Code and Service Tag are found on the front of the system by pulling out the information tag. Alternatively, the information may be on a sticker on the chassis of the system. This information is used by Dell to route support calls to the appropriate personnel.

## Accessing system information by using QRL

You can use the Quick Resource Locator (QRL) to get immediate access to the information about your system.

### Prerequisites

Ensure that your smartphone or tablet has the QR code scanner installed.

### About this task

The QRL includes the following information about your system:

- How-to videos
- Reference materials, including the Owner's Manual, LCD diagnostics, and mechanical overview
- Your system service tag to quickly access your specific hardware configuration and warranty information
- A direct link to Dell to contact technical support and sales teams

#### Steps

1. Go to **Dell.com/QRL** and navigate to your specific product or
2. Use your smartphone or tablet to scan the model-specific Quick Resource (QR) code located in the following image or on your Dell PowerEdge system:

