

Dell Latitude 5511

Service Manual

Notes, cautions, and warnings

 **NOTE:** A NOTE indicates important information that helps you make better use of your product.

 **CAUTION:** A CAUTION indicates either potential damage to hardware or loss of data and tells you how to avoid the problem.

 **WARNING:** A WARNING indicates a potential for property damage, personal injury, or death.

© 2020 Dell Inc. or its subsidiaries. All rights reserved. Dell, EMC, and other trademarks are trademarks of Dell Inc. or its subsidiaries. Other trademarks may be trademarks of their respective owners.

1 Working on your computer	6
Safety instructions	6
Before working inside your computer	6
Safety precautions	7
Electrostatic discharge—ESD protection	7
ESD field service kit	8
Transporting sensitive components	8
After working inside your computer	9
2 Technology and components	10
DDR4	10
USB Type-C	11
HDMI 2.0	13
Power button LED behavior	13
3 Major components of your system	16
4 Disassembly and reassembly	18
Base cover	18
Removing the base cover	18
Installing the base cover	21
Battery	24
Lithium-ion battery precautions	24
Removing the battery	24
Installing the battery	26
Memory modules	28
Removing the memory modules	28
Installing the memory modules	29
WLAN card	31
Removing the WLAN card	31
Installing the WLAN card	33
WWAN card	35
Removing the WWAN	35
Installing the WWAN	37
Hard disk drive	39
Removing the Hard drive	39
Installing the Hard drive	41
Coin-cell battery	42
Removing the Coin-cell	42
Installing the Coin-cell	43
DC-in port	45
Removing the DC-in	45
Installing the DC-in	47
Solid-state drive	49

Removing the SSD.....	49
Installing the SSD.....	50
Inner frame.....	52
Removing the inner frame.....	52
Installing the inner frame.....	55
Touchpad buttons.....	58
Touchpad buttons.....	58
SmartCard reader.....	62
Removing the smart card reader board.....	62
Installing the smart card reader board.....	64
Touchpad buttons.....	66
Removing the touchpad buttons.....	66
Installing the touchpad buttons.....	68
LED board.....	70
Removing the LED board.....	70
Installing the LED board.....	72
Speakers.....	74
Removing the speakers.....	74
Installing the speakers.....	76
Heatsink assembly-Discrete.....	78
Removing the heatsink assembly-discrete.....	78
Installing the heatsink assembly-discrete.....	81
System board.....	83
Removing the system board.....	83
Installing the system board.....	86
Keyboard.....	89
Removing the Keyboard.....	89
Installing the Keyboard.....	91
Keyboard bracket.....	93
Removing the keyboard bracket.....	93
Installing the keyboard bracket.....	95
Power button.....	97
Removing the power button with fingerprint reader.....	97
Installing the power button with fingerprint.....	98
Display assembly.....	100
Removing the display assembly.....	100
Installing the display assembly.....	105
Display bezel.....	110
Removing the display bezel.....	110
Installing the display bezel.....	112
Hinge caps.....	114
Removing the hinge caps.....	114
Installing the hinge caps.....	116
Display panel.....	118
Removing the display panel.....	118
Installing the display panel.....	122
Palmrest assembly.....	125
Removing the palm-rest and keyboard assembly.....	125
Installing the palm-rest and keyboard assembly.....	126

5 Troubleshooting.....	129
Enhanced Pre-Boot System Assessment (ePSA) diagnostics.....	129
Running the ePSA diagnostics.....	129
System diagnostic lights.....	129
WiFi power cycle.....	130
6 Getting help.....	131
Contacting Dell.....	131

Working on your computer

Safety instructions

Prerequisites

Use the following safety guidelines to protect your computer from potential damage and to ensure your personal safety. Unless otherwise noted, each procedure included in this document assumes that the following conditions exist:

- You have read the safety information that shipped with your computer.
- A component can be replaced or, if purchased separately, installed by performing the removal procedure in reverse order.

About this task

 **NOTE:** Disconnect all power sources before opening the computer cover or panels. After you finish working inside the computer, replace all covers, panels, and screws before connecting to the power source.

 **WARNING:** Before working inside your computer, read the safety information that shipped with your computer. For additional safety best practices information, see the [Regulatory Compliance Homepage](#)

 **CAUTION:** Many repairs may only be done by a certified service technician. You should only perform troubleshooting and simple repairs as authorized in your product documentation, or as directed by the online or telephone service and support team. Damage due to servicing that is not authorized by Dell is not covered by your warranty. Read and follow the safety instructions that came with the product.

 **CAUTION:** To avoid electrostatic discharge, ground yourself by using a wrist grounding strap or by periodically touching an unpainted metal surface at the same time as touching a connector on the back of the computer.

 **CAUTION:** Handle components and cards with care. Do not touch the components or contacts on a card. Hold a card by its edges or by its metal mounting bracket. Hold a component such as a processor by its edges, not by its pins.

 **CAUTION:** When you disconnect a cable, pull on its connector or on its pull-tab, not on the cable itself. Some cables have connectors with locking tabs; if you are disconnecting this type of cable, press in on the locking tabs before you disconnect the cable. As you pull connectors apart, keep them evenly aligned to avoid bending any connector pins. Also, before you connect a cable, ensure that both connectors are correctly oriented and aligned.

 **NOTE:** The color of your computer and certain components may appear differently than shown in this document.

 **CAUTION:** System will shut down if side covers are removed while the system is running. The system will not power on if the side cover is removed.

Before working inside your computer

About this task

To avoid damaging your computer, perform the following steps before you begin working inside the computer.

Steps

1. Ensure that you follow the safety precautions.
2. Ensure that your work surface is flat and clean to prevent the computer cover from being scratched.
3. Turn off your computer.
4. Disconnect all network cables from the computer.

 **CAUTION:** To disconnect a network cable, first unplug the cable from your computer and then unplug the cable from the network device.

5. Disconnect your computer and all attached devices from their electrical outlets.
6. Press and hold the power button while the computer is unplugged to ground the system board.

 **NOTE:** To avoid electrostatic discharge, ground yourself by using a wrist grounding strap or by periodically touching an unpainted metal surface at the same time as touching a connector on the back of the computer.

Safety precautions

The safety precautions chapter details the primary steps to be taken before performing any disassembly instructions.

Observe the following safety precautions before you perform any installation or break/fix procedures involving disassembly or reassembly:

- Turn off the system and all attached peripherals.
- Disconnect the system and all attached peripherals from AC power.
- Disconnect all network cables, telephone, and telecommunications lines from the system.
- Use an ESD field service kit when working inside any tablet/notebook/desktop to avoid electrostatic discharge (ESD) damage.
- After removing any system component, carefully place the removed component on an anti-static mat.
- Wear shoes with non-conductive rubber soles to reduce the chance of getting electrocuted.

Standby power

Dell products with standby power must be unplugged before you open the case. Systems that incorporate standby power are essentially powered while turned off. The internal power enables the system to be remotely turned on (wake on LAN) and suspended into a sleep mode and has other advanced power management features.

Unplugging, pressing and holding the power button for 15 seconds should discharge residual power in the system board. Remove the battery from tablets/notebooks.

Bonding

Bonding is a method for connecting two or more grounding conductors to the same electrical potential. This is done through the use of a field service electrostatic discharge (ESD) kit. When connecting a bonding wire, ensure that it is connected to bare metal and never to a painted or non-metal surface. The wrist strap should be secure and in full contact with your skin, and ensure that you remove all jewelry such as watches, bracelets, or rings prior to bonding yourself and the equipment.

Electrostatic discharge—ESD protection

ESD is a major concern when you handle electronic components, especially sensitive components such as expansion cards, processors, memory DIMMs, and system boards. Very slight charges can damage circuits in ways that may not be obvious, such as intermittent problems or a shortened product life span. As the industry pushes for lower power requirements and increased density, ESD protection is an increasing concern.

Due to the increased density of semiconductors used in recent Dell products, the sensitivity to static damage is now higher than in previous Dell products. For this reason, some previously approved methods of handling parts are no longer applicable.

Two recognized types of ESD damage are catastrophic and intermittent failures.

- **Catastrophic** – Catastrophic failures represent approximately 20 percent of ESD-related failures. The damage causes an immediate and complete loss of device functionality. An example of catastrophic failure is a memory DIMM that has received a static shock and immediately generates a "No POST/No Video" symptom with a beep code emitted for missing or nonfunctional memory.
- **Intermittent** – Intermittent failures represent approximately 80 percent of ESD-related failures. The high rate of intermittent failures means that most of the time when damage occurs, it is not immediately recognizable. The DIMM receives a static shock, but the tracing is merely weakened and does not immediately produce outward symptoms related to the damage. The weakened trace may take weeks or months to melt, and in the meantime may cause degradation of memory integrity, intermittent memory errors, etc.

The more difficult type of damage to recognize and troubleshoot is the intermittent (also called latent or "walking wounded") failure.

Perform the following steps to prevent ESD damage:

- Use a wired ESD wrist strap that is properly grounded. The use of wireless anti-static straps is no longer allowed; they do not provide adequate protection. Touching the chassis before handling parts does not ensure adequate ESD protection on parts with increased sensitivity to ESD damage.
- Handle all static-sensitive components in a static-safe area. If possible, use anti-static floor pads and workbench pads.

- When unpacking a static-sensitive component from its shipping carton, do not remove the component from the anti-static packing material until you are ready to install the component. Before unwrapping the anti-static packaging, ensure that you discharge static electricity from your body.
- Before transporting a static-sensitive component, place it in an anti-static container or packaging.

ESD field service kit

The unmonitored Field Service kit is the most commonly used service kit. Each Field Service kit includes three main components: anti-static mat, wrist strap, and bonding wire.

Components of an ESD field service kit

The components of an ESD field service kit are:

- **Anti-Static Mat** – The anti-static mat is dissipative and parts can be placed on it during service procedures. When using an anti-static mat, your wrist strap should be snug and the bonding wire should be connected to the mat and to any bare metal on the system being worked on. Once deployed properly, service parts can be removed from the ESD bag and placed directly on the mat. ESD-sensitive items are safe in your hand, on the ESD mat, in the system, or inside a bag.
- **Wrist Strap and Bonding Wire** – The wrist strap and bonding wire can be either directly connected between your wrist and bare metal on the hardware if the ESD mat is not required, or connected to the anti-static mat to protect hardware that is temporarily placed on the mat. The physical connection of the wrist strap and bonding wire between your skin, the ESD mat, and the hardware is known as bonding. Use only Field Service kits with a wrist strap, mat, and bonding wire. Never use wireless wrist straps. Always be aware that the internal wires of a wrist strap are prone to damage from normal wear and tear, and must be checked regularly with a wrist strap tester in order to avoid accidental ESD hardware damage. It is recommended to test the wrist strap and bonding wire at least once per week.
- **ESD Wrist Strap Tester** – The wires inside of an ESD strap are prone to damage over time. When using an unmonitored kit, it is a best practice to regularly test the strap prior to each service call, and at a minimum, test once per week. A wrist strap tester is the best method for doing this test. If you do not have your own wrist strap tester, check with your regional office to find out if they have one. To perform the test, plug the wrist-strap's bonding-wire into the tester while it is strapped to your wrist and push the button to test. A green LED is lit if the test is successful; a red LED is lit and an alarm sounds if the test fails.
- **Insulator Elements** – It is critical to keep ESD sensitive devices, such as plastic heat sink casings, away from internal parts that are insulators and often highly charged.
- **Working Environment** – Before deploying the ESD Field Service kit, assess the situation at the customer location. For example, deploying the kit for a server environment is different than for a desktop or portable environment. Servers are typically installed in a rack within a data center; desktops or portables are typically placed on office desks or cubicles. Always look for a large open flat work area that is free of clutter and large enough to deploy the ESD kit with additional space to accommodate the type of system that is being repaired. The workspace should also be free of insulators that can cause an ESD event. On the work area, insulators such as Styrofoam and other plastics should always be moved at least 12 inches or 30 centimeters away from sensitive parts before physically handling any hardware components.
- **ESD Packaging** – All ESD-sensitive devices must be shipped and received in static-safe packaging. Metal, static-shielded bags are preferred. However, you should always return the damaged part using the same ESD bag and packaging that the new part arrived in. The ESD bag should be folded over and taped shut and all the same foam packing material should be used in the original box that the new part arrived in. ESD-sensitive devices should be removed from packaging only at an ESD-protected work surface, and parts should never be placed on top of the ESD bag because only the inside of the bag is shielded. Always place parts in your hand, on the ESD mat, in the system, or inside an anti-static bag.
- **Transporting Sensitive Components** – When transporting ESD sensitive components such as replacement parts or parts to be returned to Dell, it is critical to place these parts in anti-static bags for safe transport.

ESD protection summary

It is recommended that all field service technicians use the traditional wired ESD grounding wrist strap and protective anti-static mat at all times when servicing Dell products. In addition, it is critical that technicians keep sensitive parts separate from all insulator parts while performing service and that they use anti-static bags for transporting sensitive components.

Transporting sensitive components

When transporting ESD sensitive components such as replacement parts or parts to be returned to Dell, it is critical to place these parts in anti-static bags for safe transport.

Lifting equipment

Adhere to the following guidelines when lifting heavy weight equipment:

 **CAUTION: Do not lift greater than 50 pounds. Always obtain additional resources or use a mechanical lifting device.**

1. Get a firm balanced footing. Keep your feet apart for a stable base, and point your toes out.
2. Tighten stomach muscles. Abdominal muscles support your spine when you lift, offsetting the force of the load.
3. Lift with your legs, not your back.
4. Keep the load close. The closer it is to your spine, the less force it exerts on your back.
5. Keep your back upright, whether lifting or setting down the load. Do not add the weight of your body to the load. Avoid twisting your body and back.
6. Follow the same techniques in reverse to set the load down.

After working inside your computer

About this task

After you complete any replacement procedure, ensure that you connect any external devices, cards, and cables before turning on your computer.

Steps

1. Connect any telephone or network cables to your computer.

 **CAUTION: To connect a network cable, first plug the cable into the network device and then plug it into the computer.**

2. Connect your computer and all attached devices to their electrical outlets.
3. Turn on your computer.
4. If required, verify that the computer works correctly by running the diagnostic tool.

Technology and components

NOTE: Instructions provided in this section are applicable on computers shipped with Windows 10 operating system. Windows 10 is factory-installed with this computer.

Topics:

- [DDR4](#)
- [USB Type-C](#)
- [HDMI 2.0](#)
- [Power button LED behavior](#)

DDR4

DDR4 (double data rate fourth generation) memory is a higher-speed successor to the DDR2 and DDR3 technologies and allows up to 512 GB in capacity, compared to the DDR3's maximum of 128 GB per DIMM. DDR4 synchronous dynamic random-access memory is keyed differently from both SDRAM and DDR to prevent the user from installing the wrong type of memory into the system.

DDR4 needs 20 percent less or just 1.2 volts, compared to DDR3 which requires 1.5 volts of electrical power to operate. DDR4 also supports a new, deep power-down mode that allows the host device to go into standby without needing to refresh its memory. Deep power-down mode is expected to reduce standby power consumption by 40 to 50 percent.

DDR4 Details

There are subtle differences between DDR3 and DDR4 memory modules, as listed below.

Key notch difference

The key notch on a DDR4 module is in a different location from the key notch on a DDR3 module. Both notches are on the insertion edge but the notch location on the DDR4 is slightly different, to prevent the module from being installed into an incompatible board or platform.

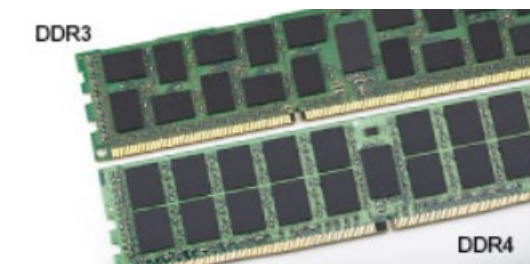

Figure 1. Notch difference

Increased thickness

DDR4 modules are slightly thicker than DDR3, to accommodate more signal layers.

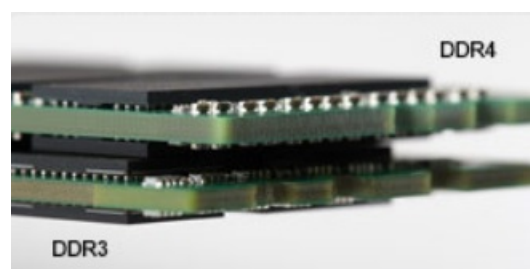

Figure 2. Thickness difference

Curved edge

DDR4 modules feature a curved edge to help with insertion and alleviate stress on the PCB during memory installation.

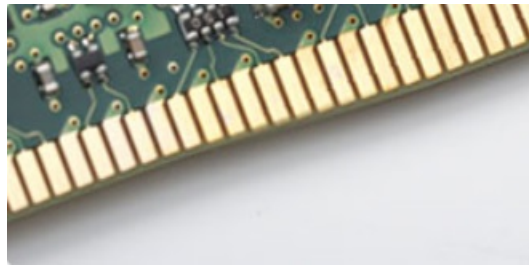

Figure 3. Curved edge

Memory Errors

Memory errors on the system display the new ON-FLASH-FLASH or ON-FLASH-ON failure code. If all memory fails, the LCD does not turn on. Troubleshoot for possible memory failure by trying known good memory modules in the memory connectors on the bottom of the system or under the keyboard, as in some portable systems.

NOTE: The DDR4 memory is imbedded in board and not a replaceable DIMM as shown and referred.

USB Type-C

USB Type-C is a new, tiny physical connector. The connector itself can support various exciting new USB standards like USB 3.1 and USB power delivery (USB PD).

Alternate Mode

USB Type-C is a new connector standard that is very small. It is about a third the size of an old USB Type-A plug. This is a single connector standard that every device should be able to use. USB Type-C ports can support a variety of different protocols using “alternate modes,” which allows you to have adapters that can output HDMI, VGA, DisplayPort, or other types of connections from that single USB port

USB Power Delivery

The USB PD specification is also closely intertwined with USB Type-C. Currently, smartphones, tablets, and other mobile devices often use a USB connection to charge. A USB 2.0 connection provides up to 2.5 watts of power — that'll charge your phone, but that's about it. A laptop might require up to 60 watts, for example. The USB Power Delivery specification ups this power delivery to 100 watts. It's bi-directional, so a device can either send or receive power. And this power can be transferred at the same time the device is transmitting data across the connection.

This could spell the end of all those proprietary laptop charging cables, with everything charging via a standard USB connection. You could charge your laptop from one of those portable battery packs you charge your smartphones and other portable devices from today. You could plug your laptop into an external display connected to a power cable, and that external display would charge your laptop as you used it as an external display — all via the one little USB Type-C connection. To use this, the device and the cable have to support USB Power Delivery. Just having a USB Type-C connection doesn't necessarily mean they do.

USB Type-C and USB 3.1

USB 3.1 is a new USB standard. USB 3's theoretical bandwidth is 5 Gbps, while USB 3.1's is 10 Gbps. That's double the bandwidth, as fast as a first-generation Thunderbolt connector. USB Type-C isn't the same thing as USB 3.1. USB Type-C is just a connector shape, and the underlying technology could just be USB 2 or USB 3.0. In fact, Nokia's N1 Android tablet uses a USB Type-C connector, but underneath it's all USB 2.0 — not even USB 3.0. However, these technologies are closely related.

Thunderbolt over USB Type-C

Thunderbolt is a hardware interface that combines data, video, audio, and power in a single connection. Thunderbolt combines PCI Express (PCIe) and DisplayPort (DP) into one serial signal, and additionally provides DC power, all in one cable. Thunderbolt 1 and Thunderbolt 2 use the same connector as miniDP (DisplayPort) to connect to peripherals, while Thunderbolt 3 uses a USB Type-C connector.

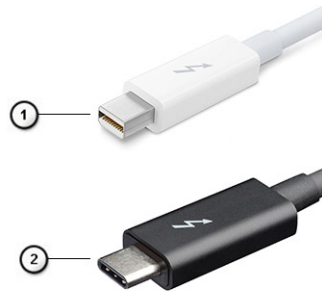

Figure 4. Thunderbolt 1 and Thunderbolt 3

1. Thunderbolt 1 and Thunderbolt 2 (using a miniDP connector)
2. Thunderbolt 3 (using a USB Type-C connector)

Thunderbolt 3 over USB Type-C

Thunderbolt 3 brings Thunderbolt to USB Type-C at speeds up to 40 Gbps, creating one compact port that does it all - delivering the fastest, most versatile connection to any dock, display or data device like an external hard drive. Thunderbolt 3 uses a USB Type-C connector/port to connect to supported peripherals.

1. Thunderbolt 3 uses USB Type-C connector and cables - It is compact and reversible
2. Thunderbolt 3 supports speed up to 40 Gbps
3. DisplayPort 1.4 – compatible with existing DisplayPort monitors, devices and cables
4. USB Power Delivery - Up to 130W on supported computers

Key Features of Thunderbolt 3 over USB Type-C

1. Thunderbolt, USB, DisplayPort and power on USB Type-C on a single cable (features vary between different products)
2. USB Type-C connector and cables which are compact and reversible
3. Supports Thunderbolt Networking (*varies between different products)
4. Supports up to 4K displays
5. Up to 40 Gbps

NOTE: Data transfer speed may vary between different devices.

Thunderbolt Icons

Protocol	USB Type-A	USB Type-C	Notes
Thunderbolt	Not Applicable		Will use industry standard icon regardless of port style (i.e., mDP or USB Type-C)
Thunderbolt w/ Power Delivery	Not Applicable		Up to 130 Watts via USB Type-C

Figure 5. Thunderbolt Iconography Variations

HDMI 2.0

This topic explains the HDMI 2.0 and its features along with the advantages.

HDMI (High-Definition Multimedia Interface) is an industry-supported, uncompressed, all-digital audio/video interface. HDMI provides an interface between any compatible digital audio/video source, such as a DVD player, or A/V receiver and a compatible digital audio and/or video monitor, such as a digital TV (DTV). The intended applications for HDMI TVs, and DVD players. The primary advantage is cable reduction and content protection provisions. HDMI supports standard, enhanced, or high-definition video, plus multichannel digital audio on a single cable.

 **NOTE: The HDMI 1.4 will provide 5.1 channel audio support.**

HDMI 2.0 Features

- **HDMI Ethernet Channel** - Adds high-speed networking to an HDMI link, allowing users to take full advantage of their IP-enabled devices without a separate Ethernet cable
- **Audio Return Channel** - Allows an HDMI-connected TV with a built-in tuner to send audio data "upstream" to a surround audio system, eliminating the need for a separate audio cable
- **3D** - Defines input/output protocols for major 3D video formats, paving the way for true 3D gaming and 3D home theater applications
- **Content Type** - Real-time signaling of content types between display and source devices, enabling a TV to optimize picture settings based on content type
- **Additional Color Spaces** - Adds support for additional color models used in digital photography and computer graphics
- **4K Support** - Enables video resolutions far beyond 1080p, supporting next-generation displays that will rival the Digital Cinema systems used in many commercial movie theaters
- **HDMI Micro Connector** - A new, smaller connector for phones and other portable devices, supporting video resolutions up to 1080p
- **Automotive Connection System** - New cables and connectors for automotive video systems, designed to meet the unique demands of the motoring environment while delivering true HD quality

Advantages of HDMI

- Quality HDMI transfers uncompressed digital audio and video for the highest, crispest image quality.
- Low -cost HDMI provides the quality and functionality of a digital interface while also supporting uncompressed video formats in a simple, cost-effective manner
- Audio HDMI supports multiple audio formats from standard stereo to multichannel surround sound
- HDMI combines video and multichannel audio into a single cable, eliminating the cost, complexity, and confusion of multiple cables currently used in A/V systems
- HDMI supports communication between the video source (such as a DVD player) and the DTV, enabling new functionality

Power button LED behavior

On certain Dell Latitude systems, the power button LED is used to provide an indication of the system status, and as a result the power button illuminates when pressed. The systems with the optional power button/fingerprint reader will have no LED under the power button and hence will apply the available LED's in the system to provide an indication of the system status.

Power button LED behavior without Fingerprint reader

- System is ON (S0) = LED illuminates solid white.
- System in Sleep/Standby (S3, SOix) = LED is off
- System is Off/Hibernating (S4/S5) = LED is off

Power On and LED behavior with Fingerprint reader

- Pressing the power button for a duration between 50 msec to 2 sec turns on the device.
- Power button does not register additional presses until the SOL (Sign-Of-Life) has been provided to the user.
- System LED's illuminates upon pressing the power button.
- All the available LED's (Keyboard backlit/ Keyboard caps lock LED/ Battery Charge LED) illuminates and displays specified behavior.

- The auditory tone is Off by default. It can be enabled in the BIOS setup.
- Safeguards do not time out if the device gets hung during the logon process.
- Dell logo: Turns on within 2 secs after pressing the power button.
- Full boot: Within 22 secs after pressing the power button.
- Below is the example timelines:

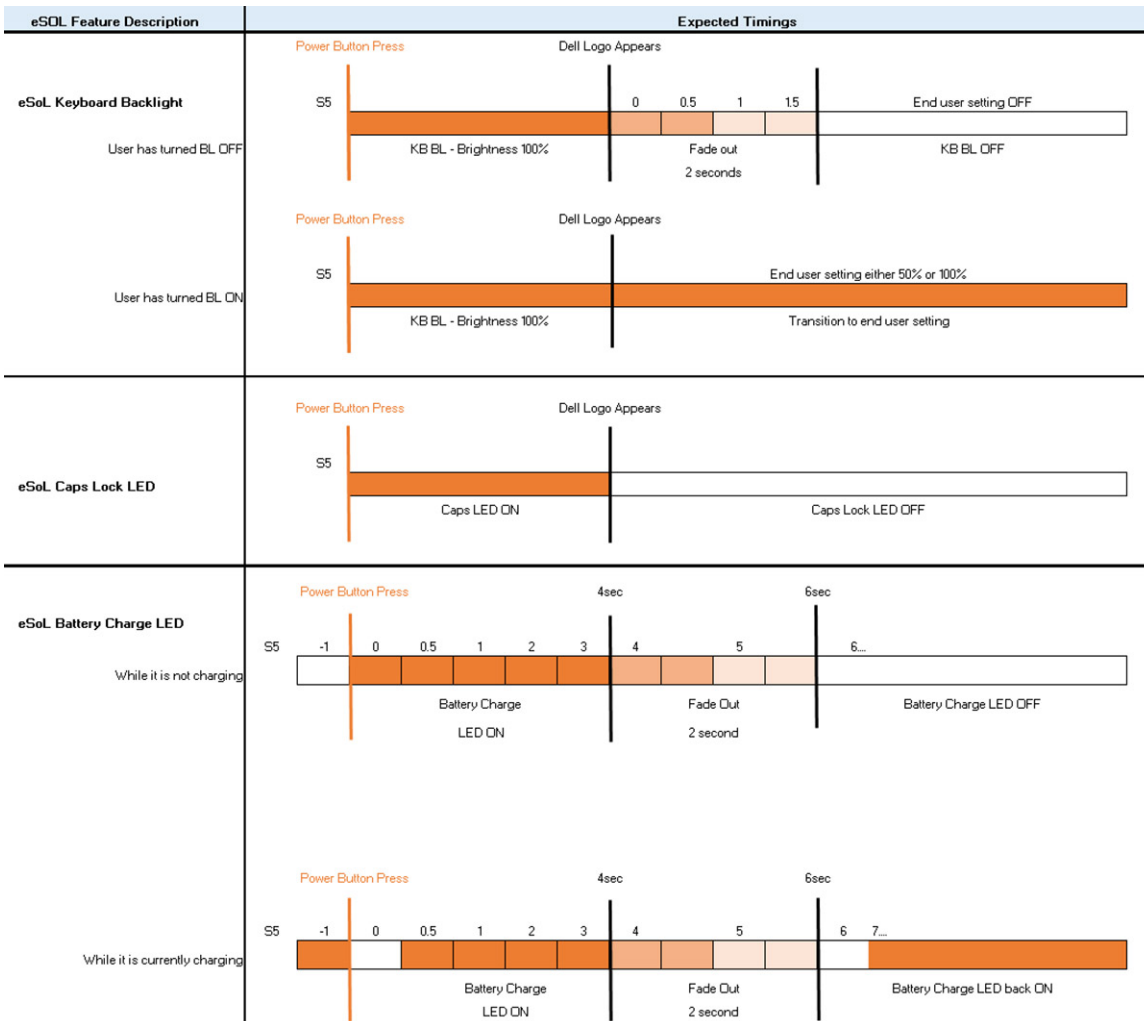

Power button with fingerprint reader will have no LED and will leverage the available LED's in the system to provide indication of the system status

• **Power Adapter LED:**

- The LED on Power adapter connector illuminates white when power is supplied from electrical outlet.

• **Battery Indicator LED:**

- If the computer is connected to an electrical outlet, the battery light operates as follows:
 1. Solid white -the battery is charging. When the charge is complete the LED turns off.
- If the computer is running on a battery, the battery light operates as follows:
 1. Off -the battery is adequately charged (or the computer is turned off).
 2. Solid amber -the battery charge is critically low. A low battery state is approximately 30 minutes or less of battery life remaining.

• **Camera LED**

- White LED activates when camera is on.

• **Mic Mute LED:**

- When activated (muted), the mic mute LED on the F4 Key should illuminate WHITE.

• **RJ45 LEDs:**

· **Table 1. LED on either side of RJ45 port**

Link speed indicator (LHS)

Activity indicator (RHS)

Green

Amber

Major components of your system

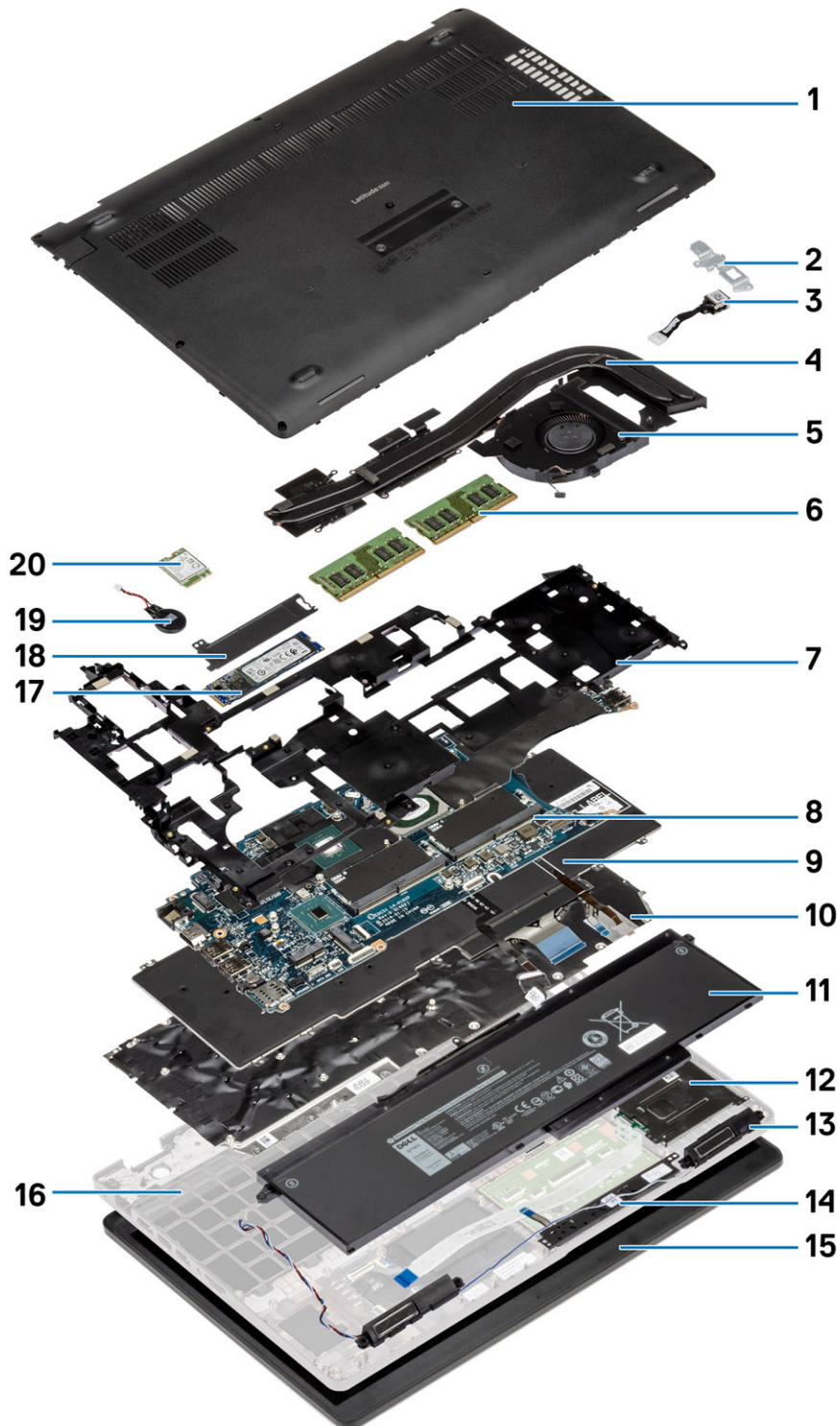

1. Base cover
3. DC-in port

2. DC-in metal bracket
4. Heatsink assembly

5. Heatsink fan
7. Inner frame
9. Keyboard
11. Battery
13. Speakers
15. Display assembly
17. Solid state drive
19. Coin-cell battery
6. Memory modules
8. Memory bracket
10. Keyboard bracket
12. SmartCard reader
14. Touchpad buttons
16. Palmrest assembly
18. SSD thermal plate
20. WWAN card

i **NOTE:** Dell provides a list of components and their part numbers for the original system configuration purchased. These parts are available according to warranty coverages purchased by the customer. Contact your Dell sales representative for purchase options.

Disassembly and reassembly

Base cover

Removing the base cover

Prerequisites

1. Follow the procedure in [Before working inside your computer](#).

About this task

The figure indicates the location of the base cover and provides a visual representation of the removal procedure.



5x
M2.5x6.3



3x
M2.5x8

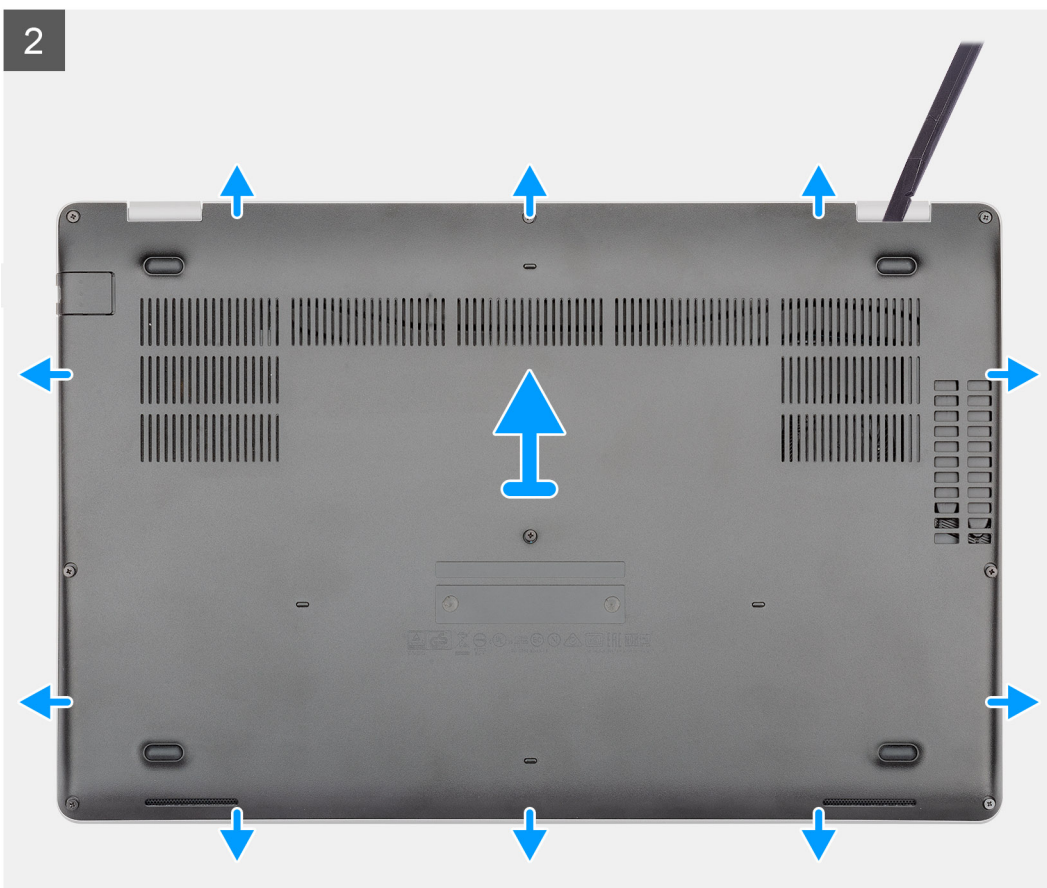
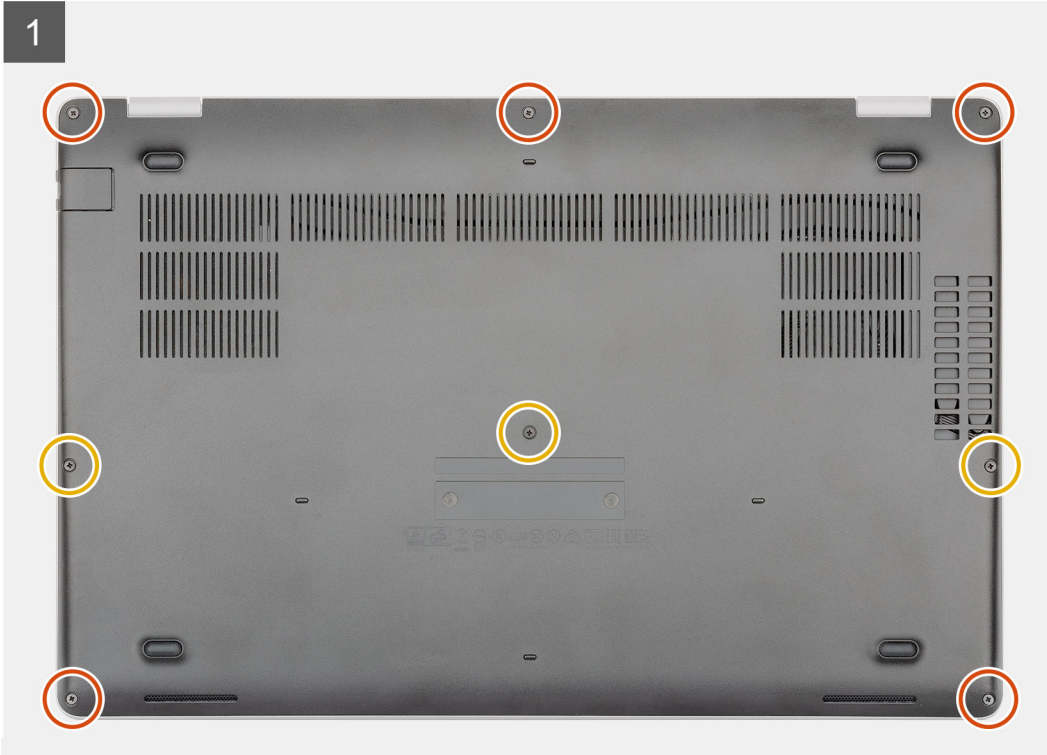



5x
M2.5x6.3



3x
M2.5x8

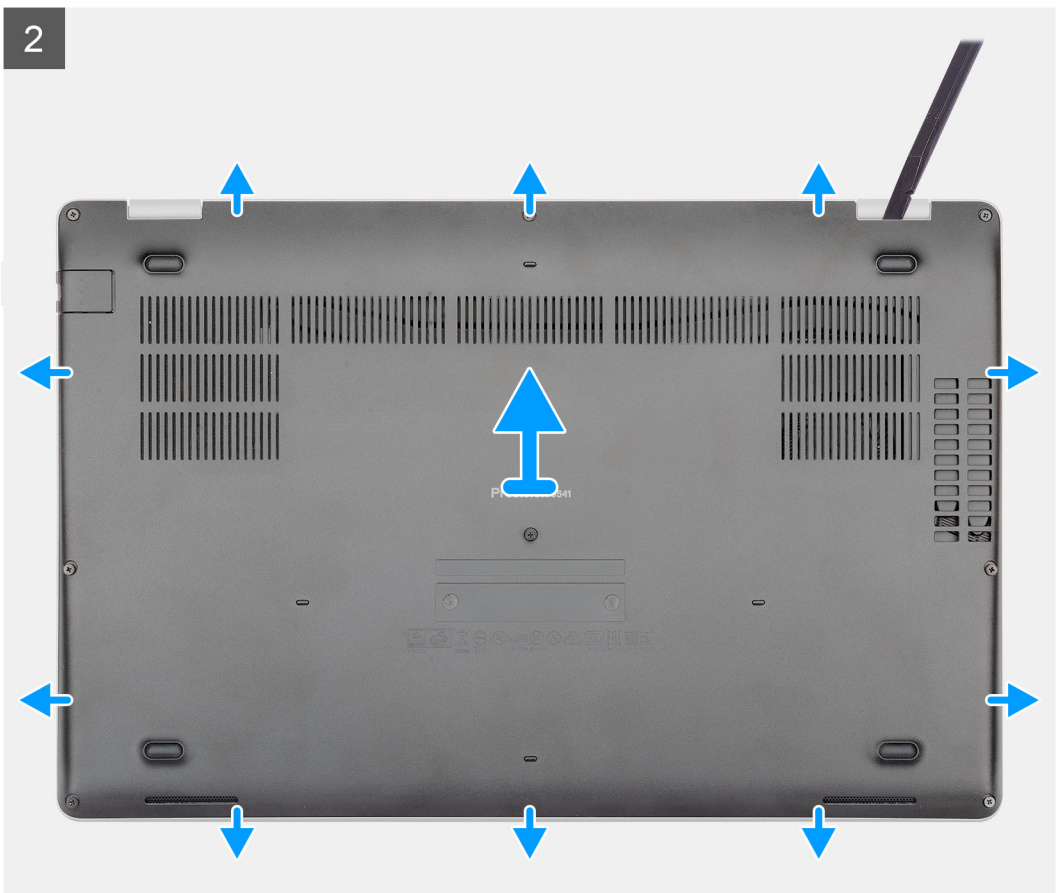
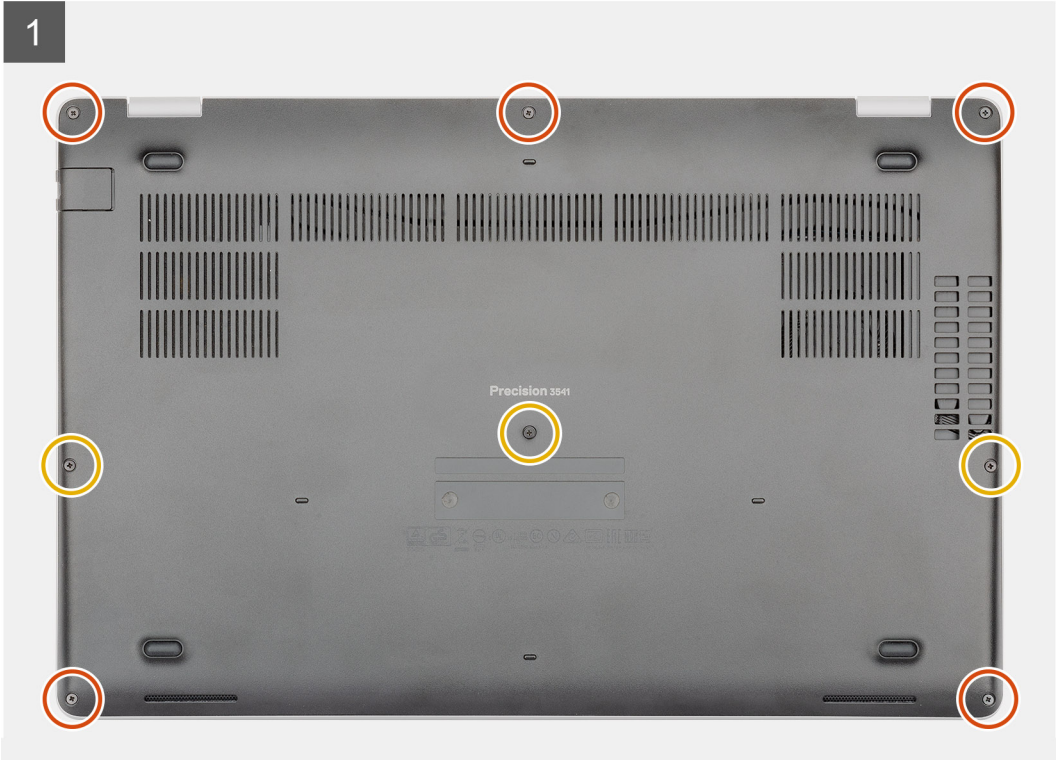

Steps

1. Remove the five (M2.5x6.3) and three (M2.5x8) captive screws that secure the base cover to the computer.
2. Pry the base cover starting from the right hinge and work your way around.
3. Lift the base cover away from the computer.

Installing the base cover

Prerequisites

If you are replacing a component, remove the existing component before performing the installation procedure.

About this task

The figure indicates the location of the base cover and provides a visual representation of the installation procedure.

1

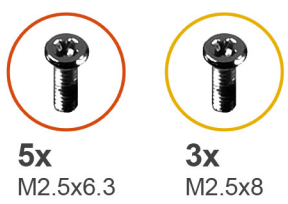
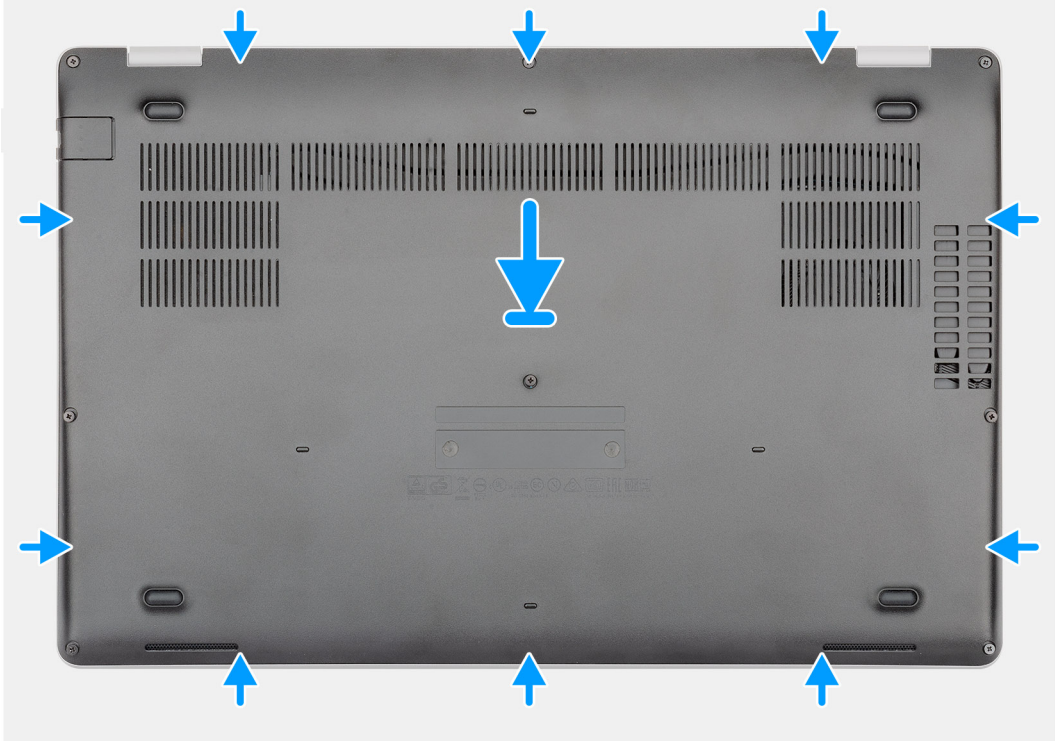

2



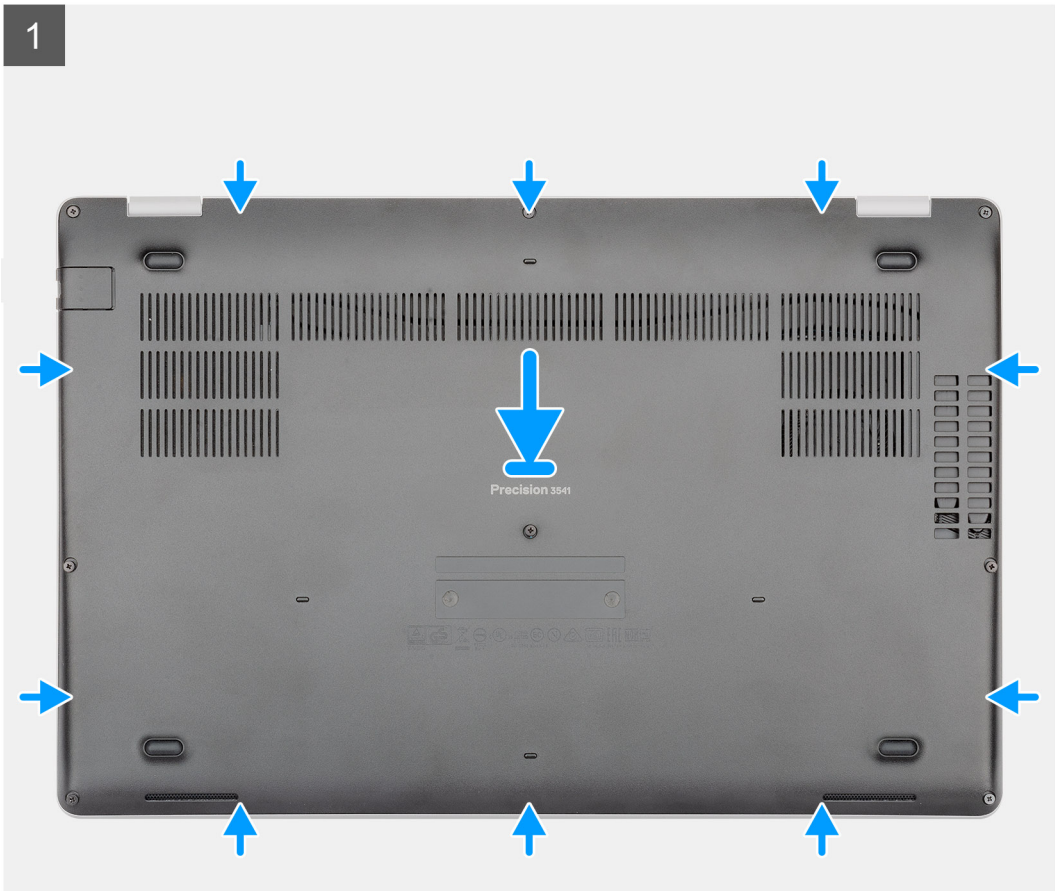

5x
M2.5x6.3



3x
M2.5x8

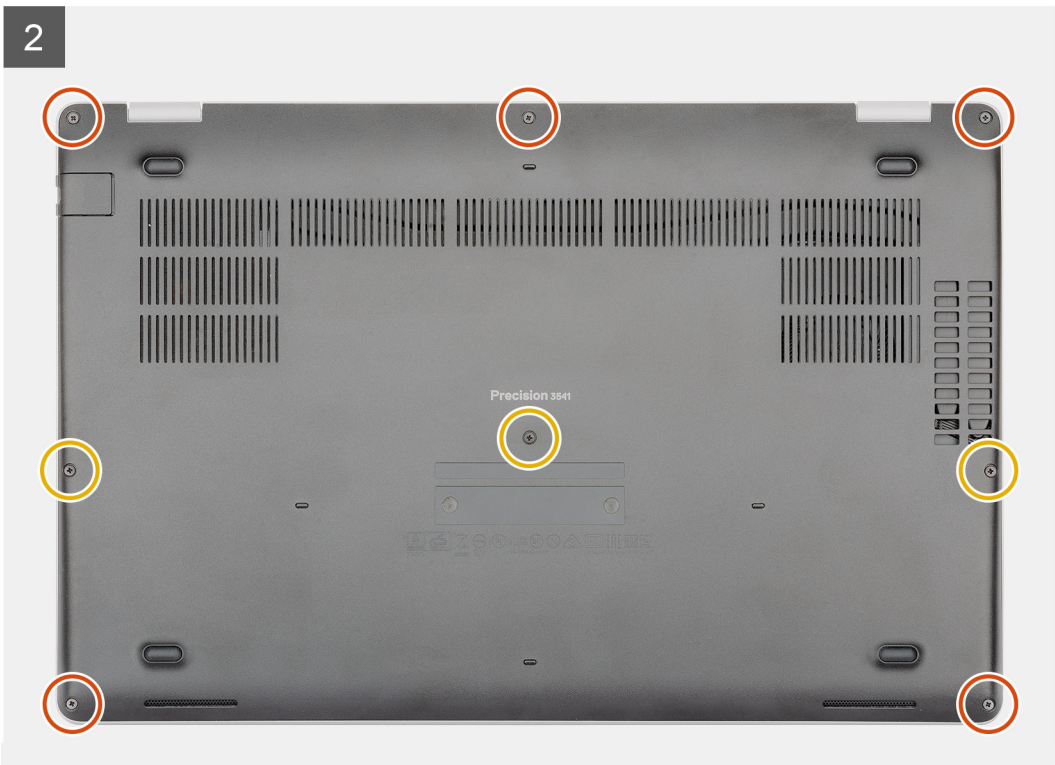

Steps

1. Place the base cover on the palm-rest and keyboard assembly, and snap the base cover into place.
2. Replace the five (M2.5x6.3) and three (M2.5x8) captive screws to secure the base cover to the computer.

Next steps

1. Follow the procedure in [After working inside your computer](#).

Battery

Lithium-ion battery precautions

⚠ CAUTION:

- Exercise caution when handling Lithium-ion batteries.
- Discharge the battery as much as possible before removing it from the system. This can be done by disconnecting the AC adapter from the system to allow the battery to drain.
- Do not crush, drop, mutilate, or penetrate the battery with foreign objects.
- Do not expose the battery to high temperatures, or disassemble battery packs and cells.
- Do not apply pressure to the surface of the battery.
- Do not bend the battery.
- Do not use tools of any kind to pry on or against the battery.
- Ensure any screws during the servicing of this product are not lost or misplaced, to prevent accidental puncture or damage to the battery and other system components.
- If the battery gets stuck inside your computer as a result of swelling, do not try to release it as puncturing, bending, or crushing a lithium-ion battery can be dangerous. In such an instance, contact Dell technical support for assistance. See www.dell.com/contactdell.
- Always purchase genuine batteries from www.dell.com or authorized Dell partners and resellers.

Removing the battery

Prerequisites

1. Follow the procedure in [Before working inside your computer](#).
2. Remove the [base cover](#).

About this task

The figure indicates the location of the battery and provides a visual representation of the removal procedure.



1x
M2x6

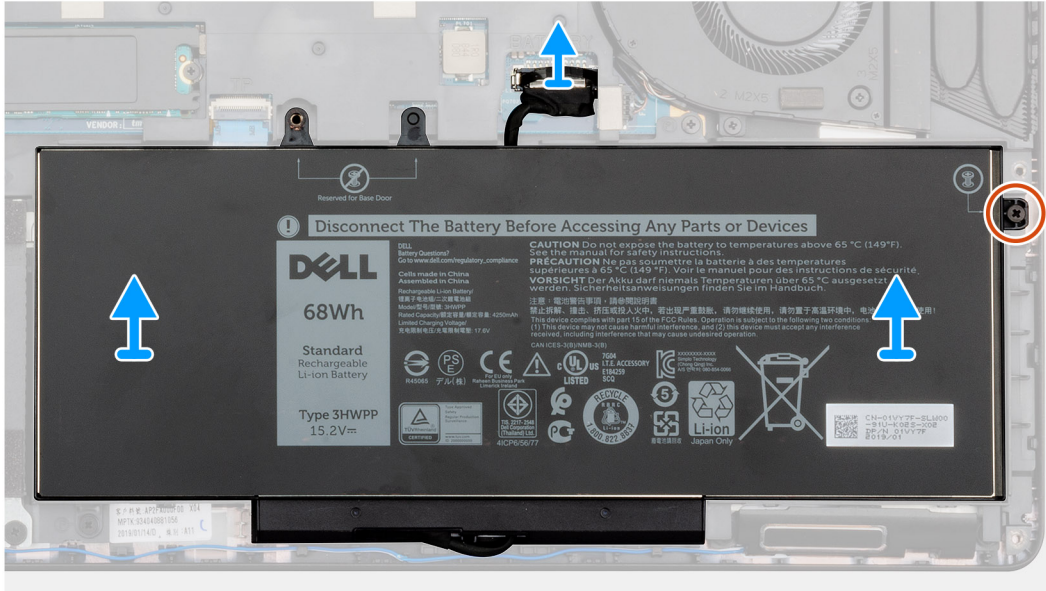
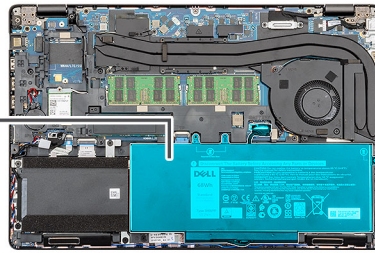
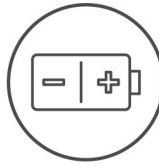

1x
M2x6

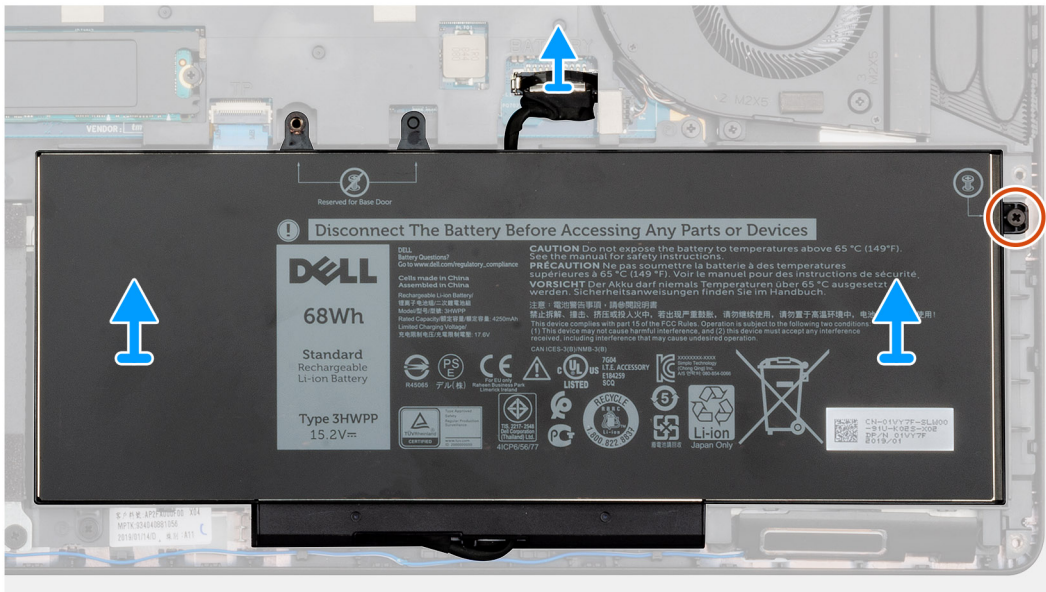
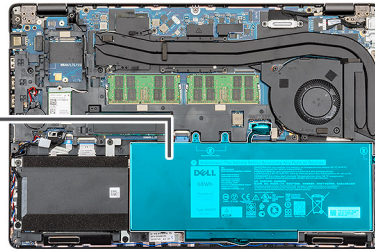
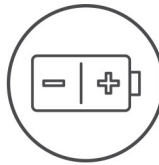

Steps

1. Disconnect the battery cable from the system board.

2. Remove the single (M2x6) captive screw that secures the battery computer.
3. Lift the battery off the computer.

Installing the battery

Prerequisites

If you are replacing a component, remove the existing component before performing the installation procedure.

About this task

The figure indicates the location of the battery and provides a visual representation of the installation procedure.



1x
M2x6

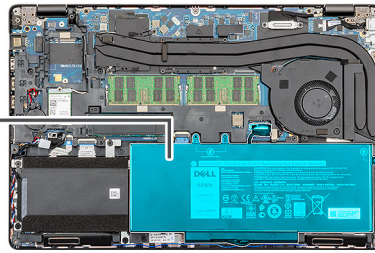
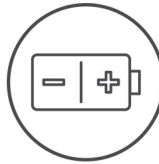

1x
M2x6

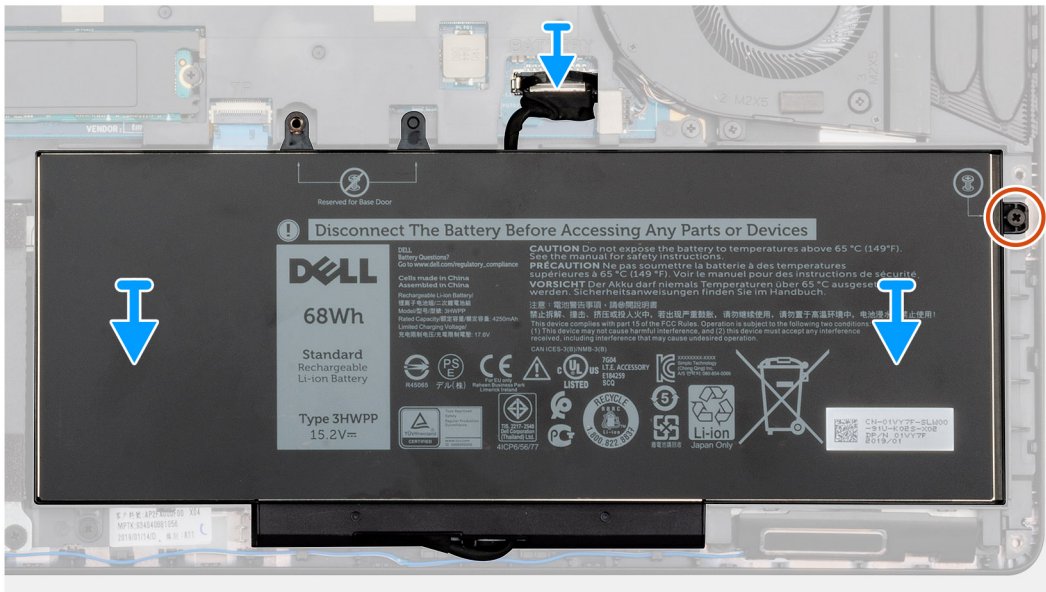
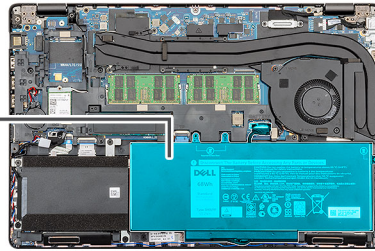
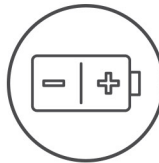

Steps

1. Place the battery on the palm-rest and keyboard assembly and align the screw holes on the battery with the screw holes on the palm-rest and keyboard assembly.
2. Replace the single (M2x6) captive screw that secures the battery to the computer.
3. Connect the battery cable to the system board.

Next steps

1. Install the [base cover](#).
2. Follow the procedure in [After working inside your computer](#).

Memory modules

Removing the memory modules

Prerequisites

1. Follow the procedure in [Before working inside your computer](#).
2. Remove the [base cover](#).
3. Remove the [battery](#).

About this task

The figure indicates the location of the memory module and provides a visual representation of the removal procedure.

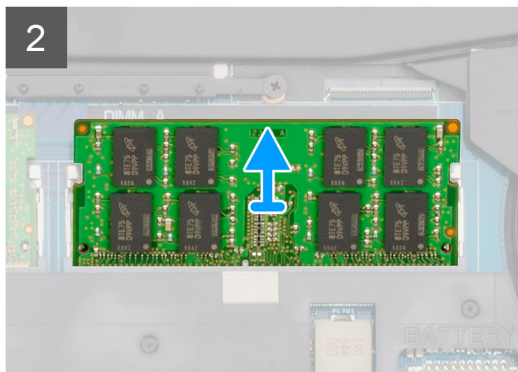
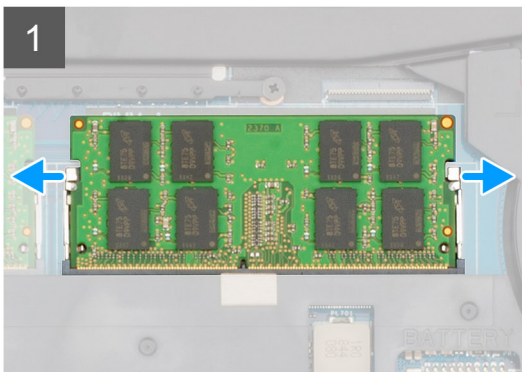
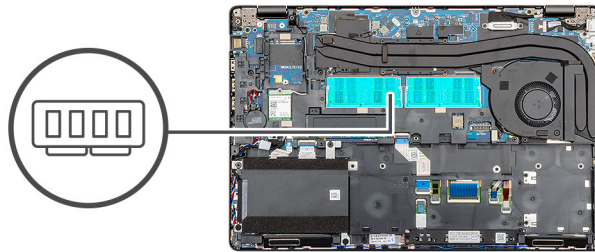
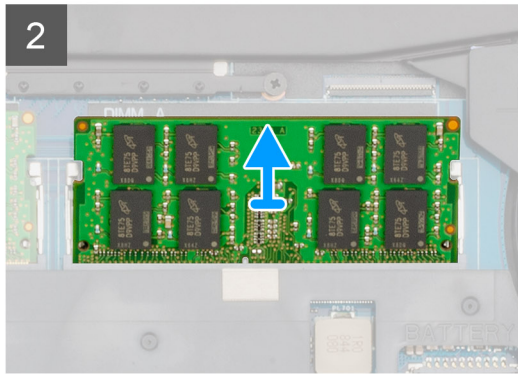
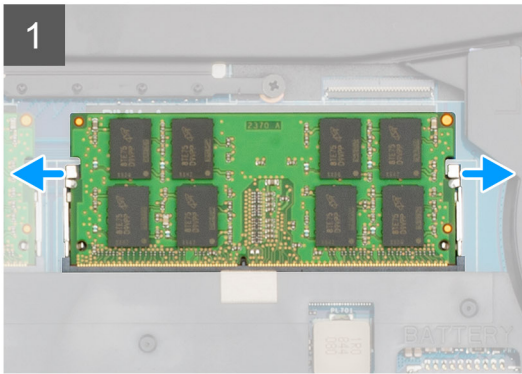
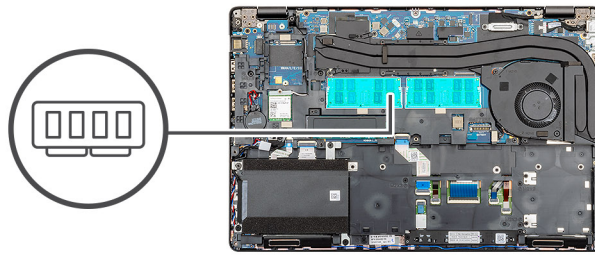

Steps

1. Using your finger tips gently spread apart the securing-clips on each end of the memory-module slot until the memory module pops up.
2. Slide and remove the memory module off the memory module slot on the system board.

Installing the memory modules

Prerequisites

If you are replacing a component, remove the existing component before performing the installation procedure.

About this task

The figure indicates the location of the memory module and provides a visual representation of the installation procedure.

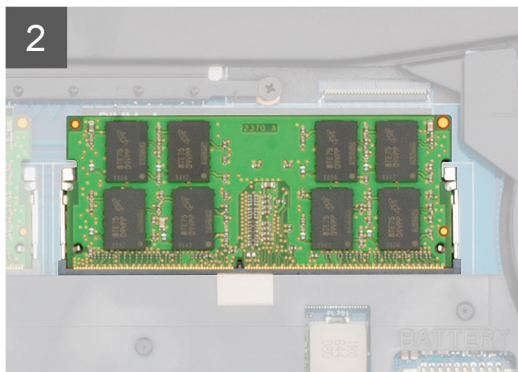
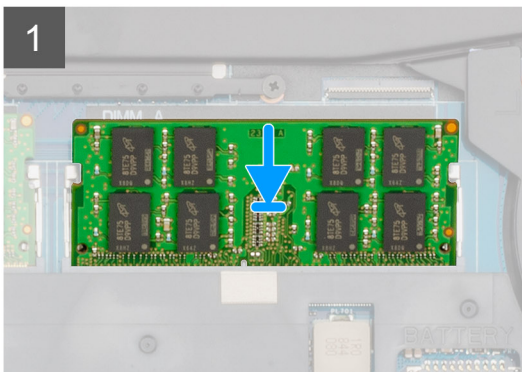
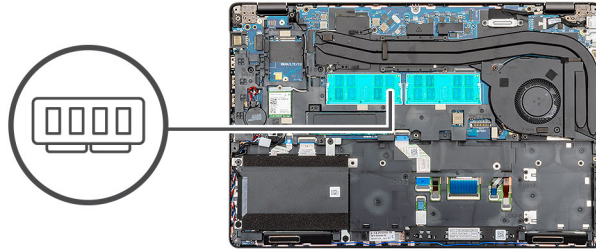
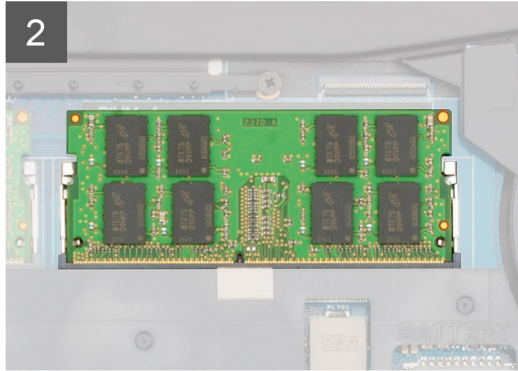
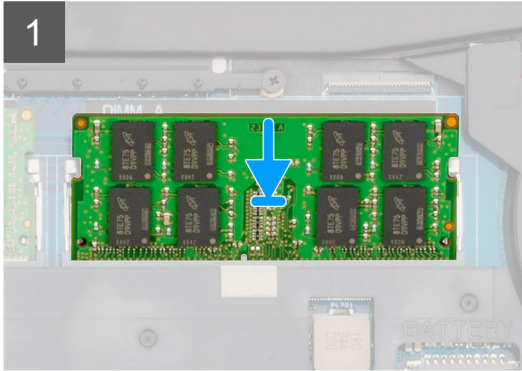
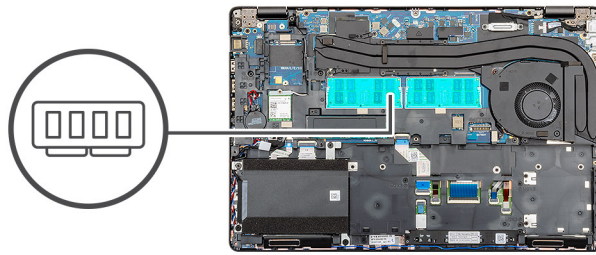

Steps

1. Align the notch on the memory module with the tab on the memory-module slot.
2. Slide the memory module firmly into the slot at an angle.
3. Press the memory module down until it clicks into place.

i **NOTE:** If you do not hear the click, remove the memory module and reinstall it.

Next steps

1. Install the [battery](#).
2. Install the [base cover](#).
3. Follow the procedure in [After working inside your computer](#).

WLAN card

Removing the WLAN card

Prerequisites

1. Follow the procedure in [Before working inside your computer](#).
2. Remove the [base cover](#).
3. Remove the [battery](#).

About this task

The figure indicates the location of the WLAN card and provides a visual representation of the removal procedure.



1x
M2x3

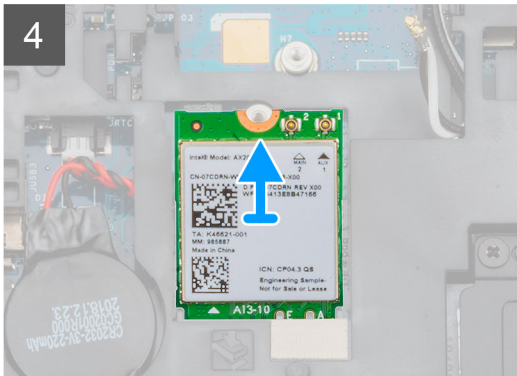
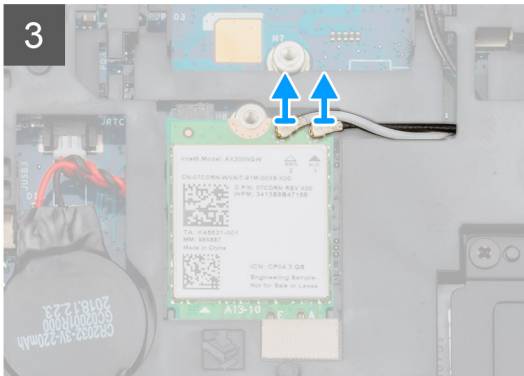
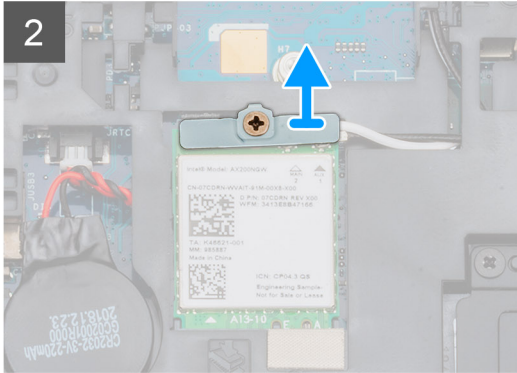
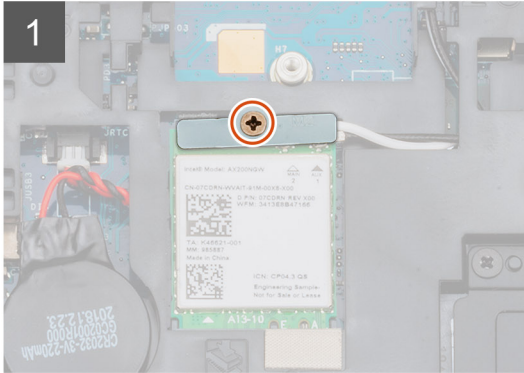
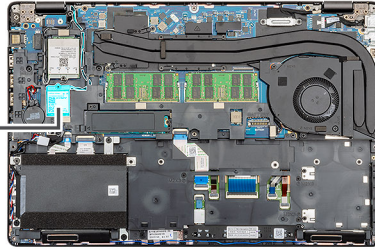

1x
M2x3

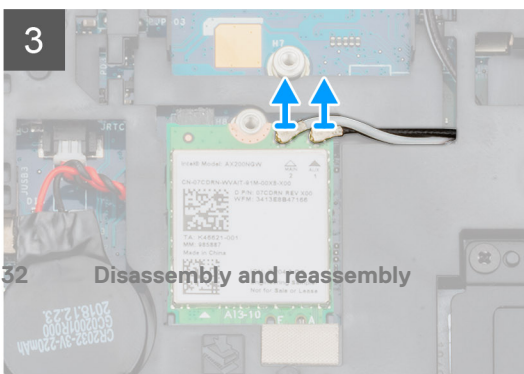
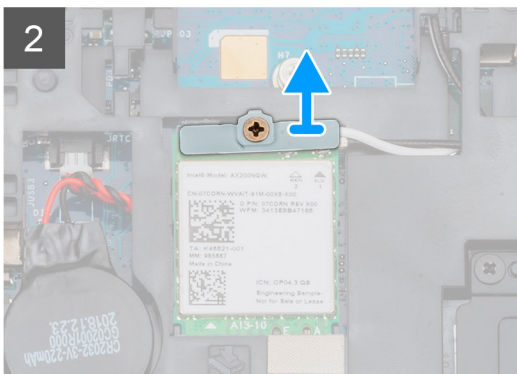
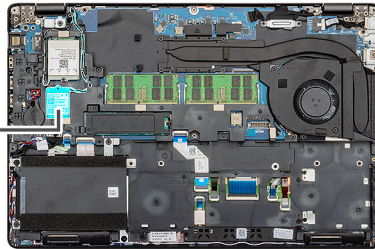

32 Disassembly and reassembly

Steps

1. Locate the WLAN card on your computer.
2. Remove the single (M2x3) screw that secures the WLAN bracket.
3. Remove the WLAN bracket from the computer.
4. Disconnect the WLAN cables from the WLAN module.
5. Remove the WLAN card out of the computer.

Installing the WLAN card

Prerequisites

If you are replacing a component, remove the existing component before performing the installation procedure.

About this task

The figure indicates the location of the WLAN card and provides a visual representation of the installation procedure.



1x
M2x3

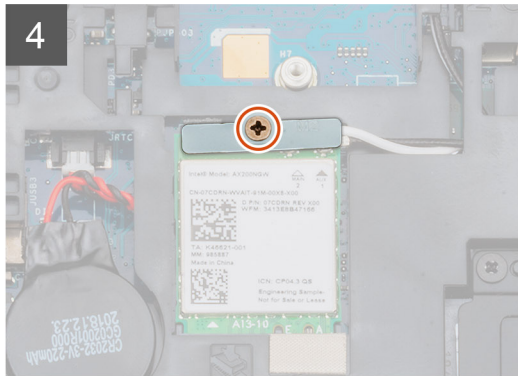
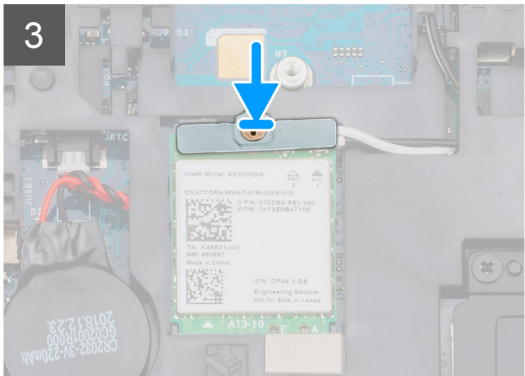
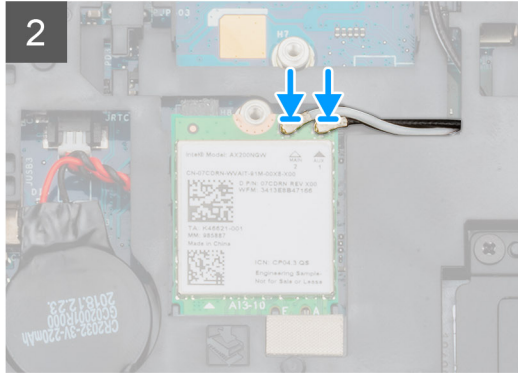
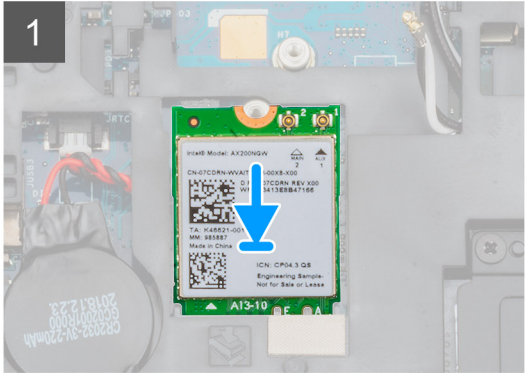
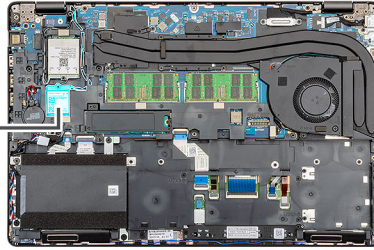

1x
M2x3

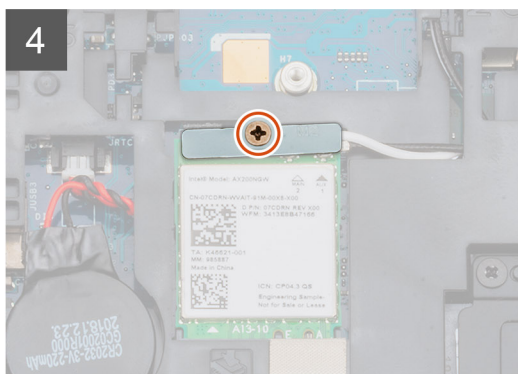
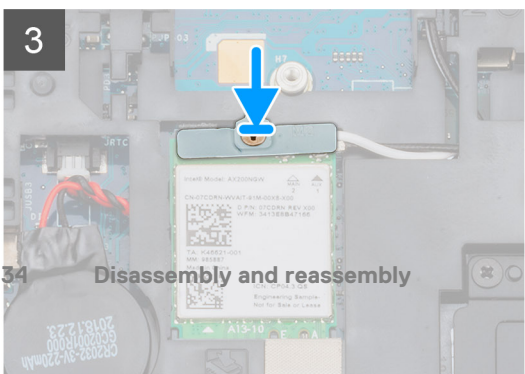
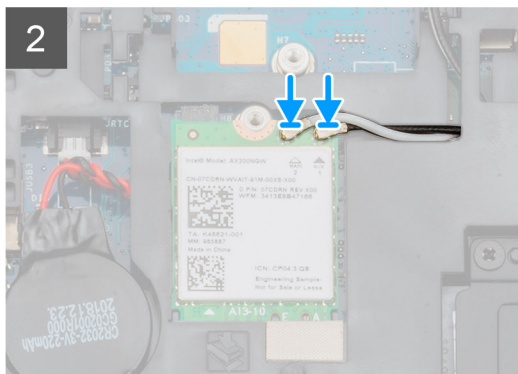
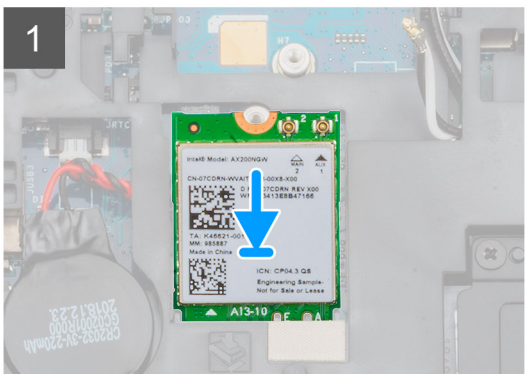
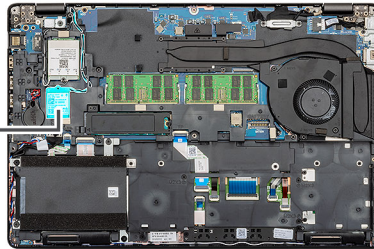

Steps

1. Locate the WLAN card slot on your computer.
2. Slide the WLAN card into the slot on the system board.
3. Reconnect the WLAN card cables to the WLAN module.
4. Place the WLAN bracket on the WLAN card and secure it with the single (M2x3) screw.

Next steps

1. Install the [battery](#).
2. Install the [base cover](#).
3. Follow the procedure in [After working inside your computer](#).

WWAN card

Removing the WWAN

Prerequisites

1. Follow the procedure in [Before working inside your computer](#).
2. Remove the [base cover](#).
3. Remove the [battery](#).

About this task

The figure indicates the location of the WWAN card and provides a visual representation of the removal procedure.



1x
M2X3

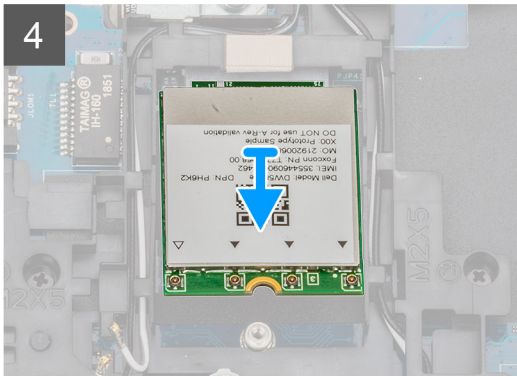
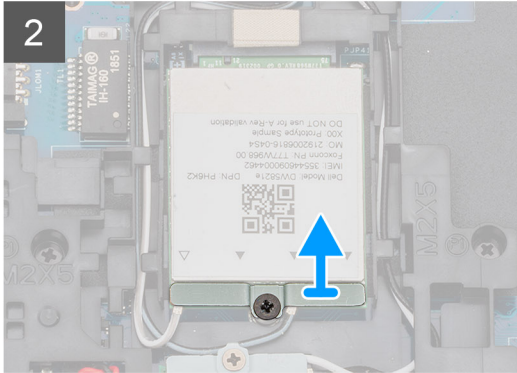
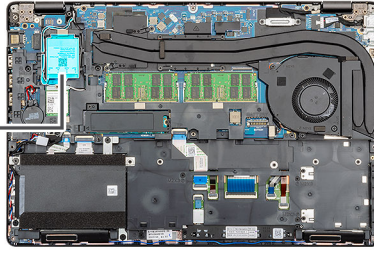

1x
M2X3

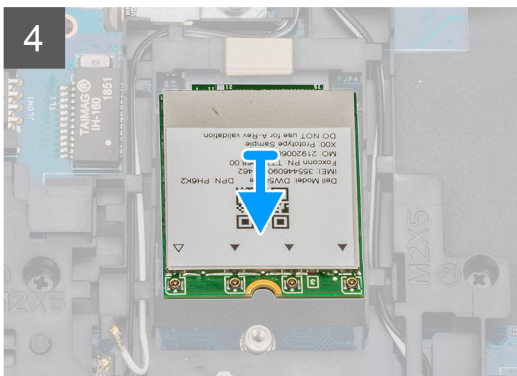
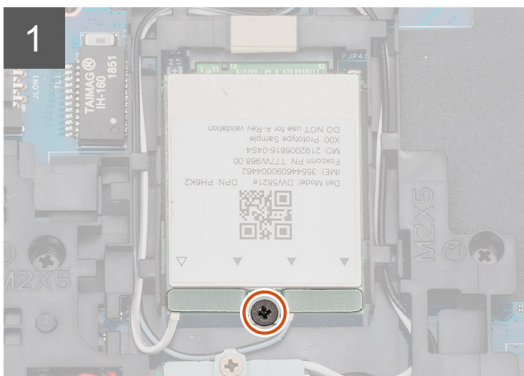
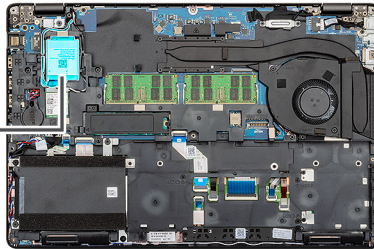

Steps

1. Locate the WWAN on your computer.
2. Remove the single (M2x3) screw that secures the WWAN metal bracket to the computer.
3. Lift the WWAN metal bracket away from the computer.
4. Disconnect the WWAN cables from the WWAN card module.
5. Slide the WWAN card out of the system.

Installing the WWAN

Prerequisites

If you are replacing a component, remove the existing component before performing the installation procedure.

About this task

The figure indicates the location of the WWAN card and provides a visual representation of the installation procedure.



1x
M2X3

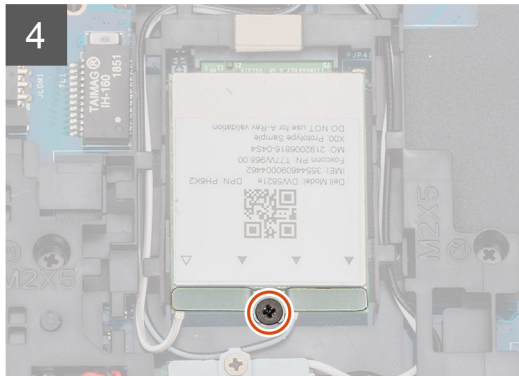
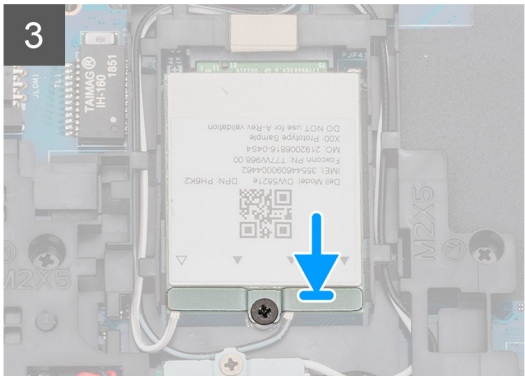
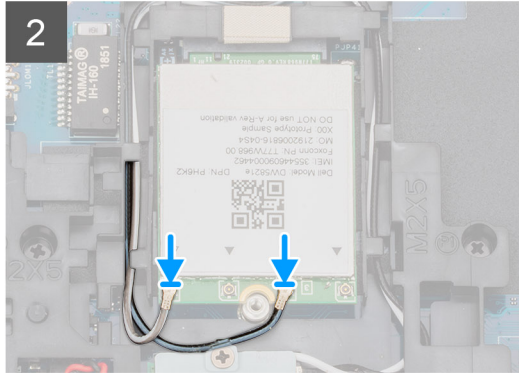
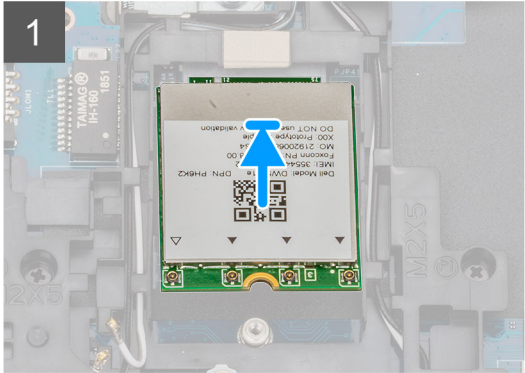
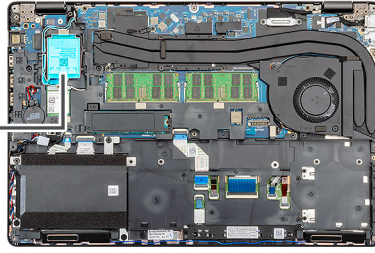

1x
M2X3

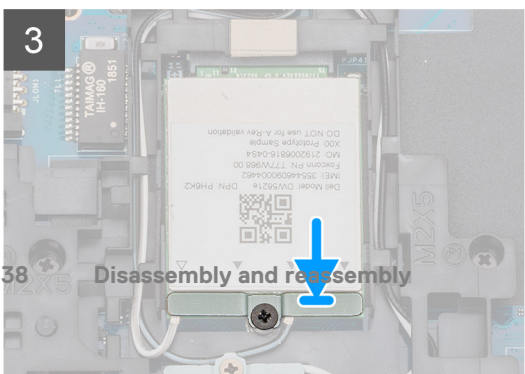
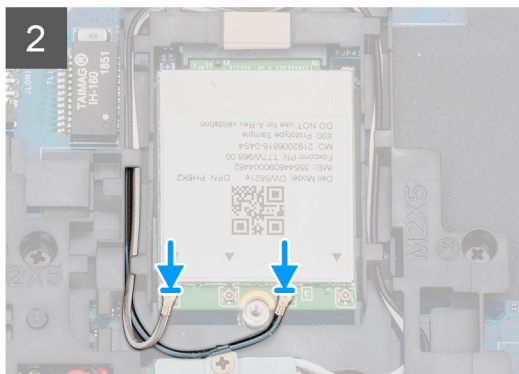
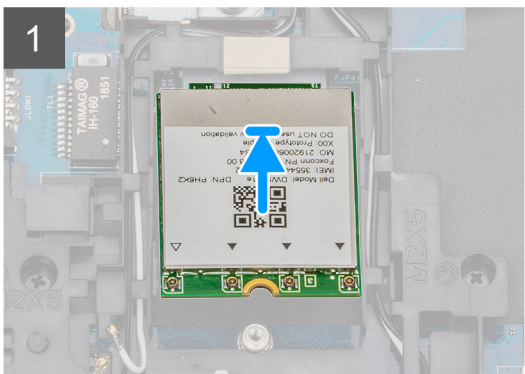
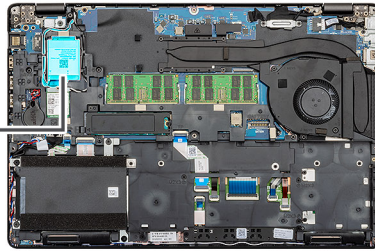

38 Disassembly and reassembly

Steps

1. Locate the WWAN slot on your computer.
2. Slide the WWAN card into the slot on your computer.
3. Reconnect the WWAN cables to the WWAN card module.
4. Place the WWAN metal bracket on the WWAN card module.
5. Replace the single (M2x3) screw to secure the module to the computer.

Next steps

1. Install the [battery](#).
2. Install the [base cover](#).
3. Follow the procedure in [After working inside your computer](#).

Hard disk drive

Removing the Hard drive

Prerequisites

1. Follow the procedure in [Before working inside your computer](#).
2. Remove the [base cover](#).
3. Remove the [battery](#).

About this task

The figure indicates the location of the HDD and provides a visual representation of the removal procedure.



4x
M2x2.7

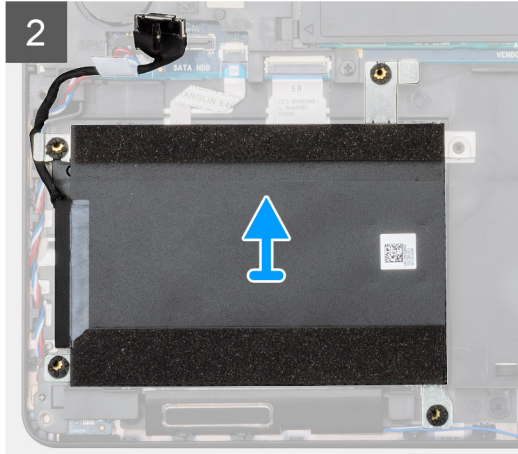
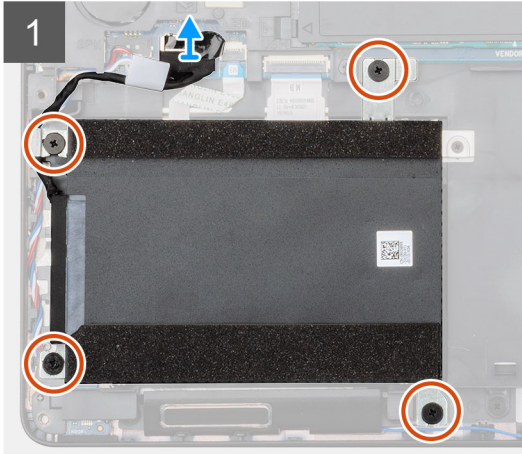
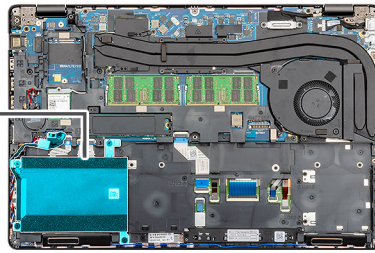

4x
M2x2.7

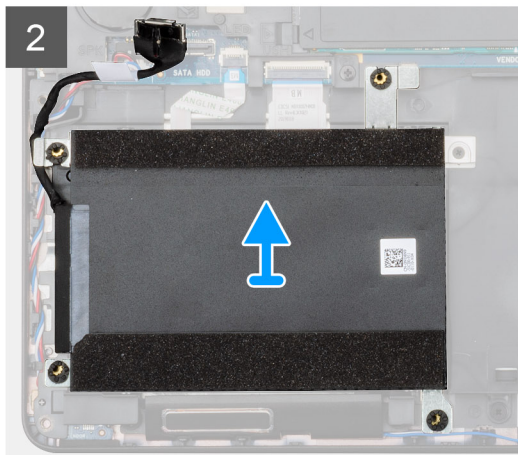
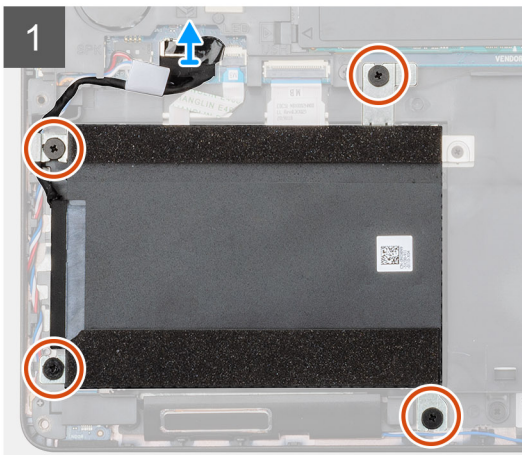
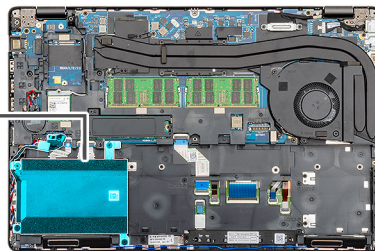

Steps

1. Locate the HDD on your computer.
2. Disconnect the HDD cable from the system board.
3. Remove the four (M2x2.7) screws that secure the HDD to the system board.
4. Remove the HDD from the computer.

Installing the Hard drive

Prerequisites

If you are replacing a component, remove the existing component before performing the installation procedure.

About this task

The figure indicates the location of the HDD and provides a visual representation of the installation procedure.



4x
M2x2.7

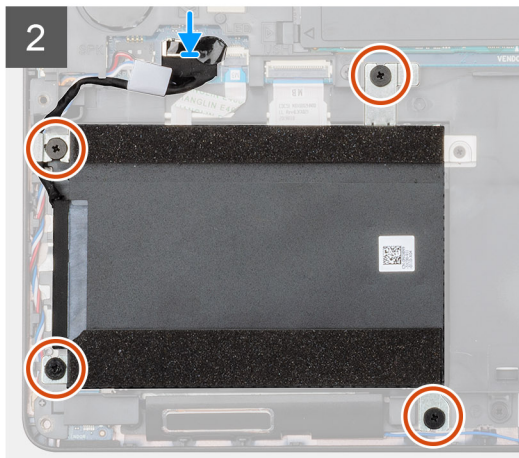
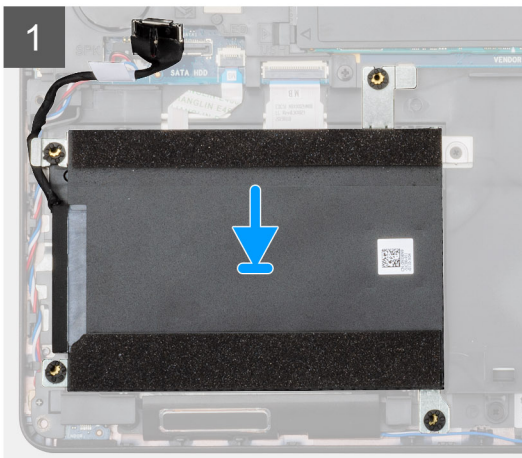
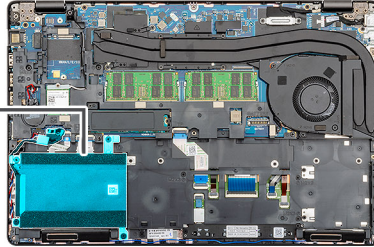

4x
M2x2.7

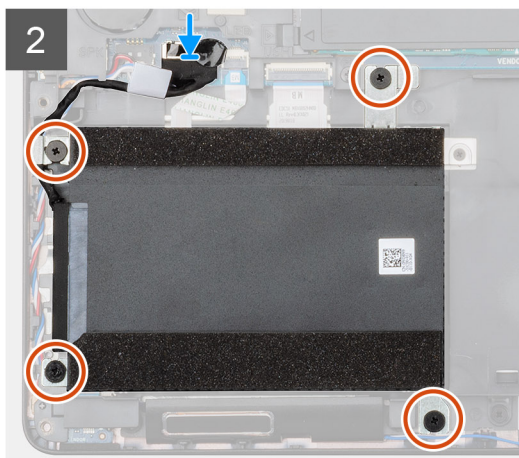
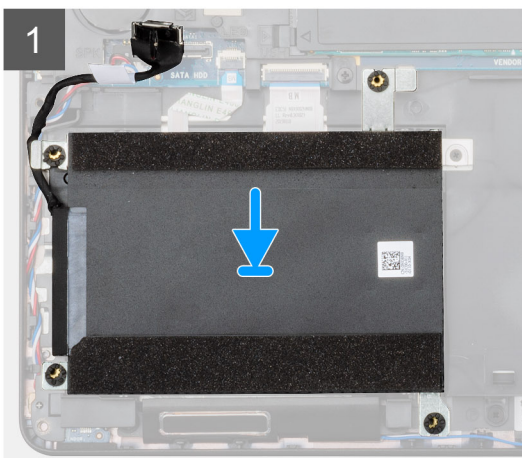
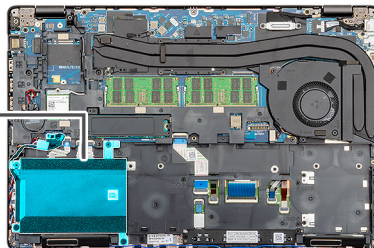

Steps

1. Locate the system board slot on your computer.
2. Align and install the HDD into the computer
3. Install the four (M2x2.7) screws that secure the HDD to the computer.
4. Connect the HDD cable on to the connector on the system board.

Next steps

1. Install the [battery](#).
2. Install the [base cover](#).
3. Follow the procedure in [After working inside your computer](#).

Coin-cell battery

Removing the Coin-cell

Prerequisites

1. Follow the procedure in [Before working inside your computer](#).
2. Remove the [base cover](#).
3. Remove the [battery](#).

About this task

The figure indicates the location of the Coin-cell and provides a visual representation of the removal procedure.

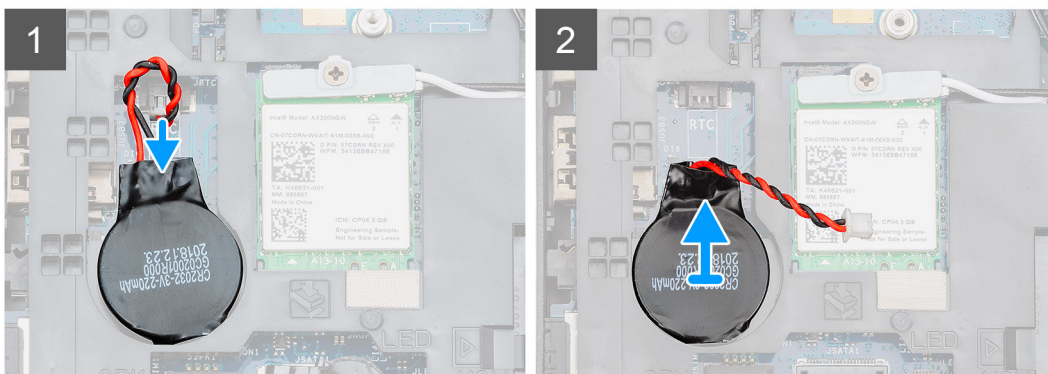
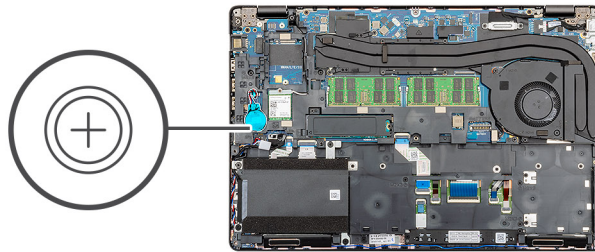
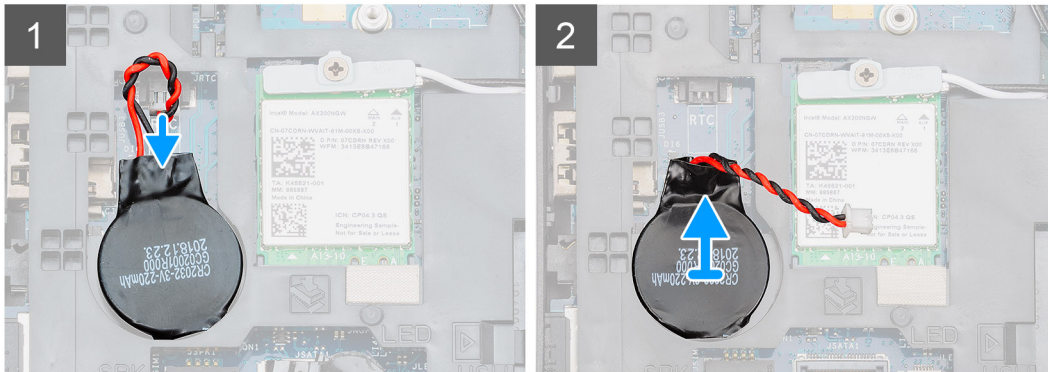
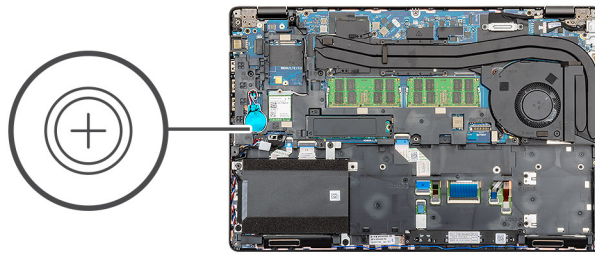

Steps

1. Locate the Coin-cell on your computer.
2. Disconnect the coin-cell cable from the system board.
3. Lift the coin-cell out of the computer.

Installing the Coin-cell

Prerequisites

If you are replacing a component, remove the existing component before performing the installation procedure.

About this task

The figure indicates the location of the coin-cell and provides a visual representation of the installation procedure.

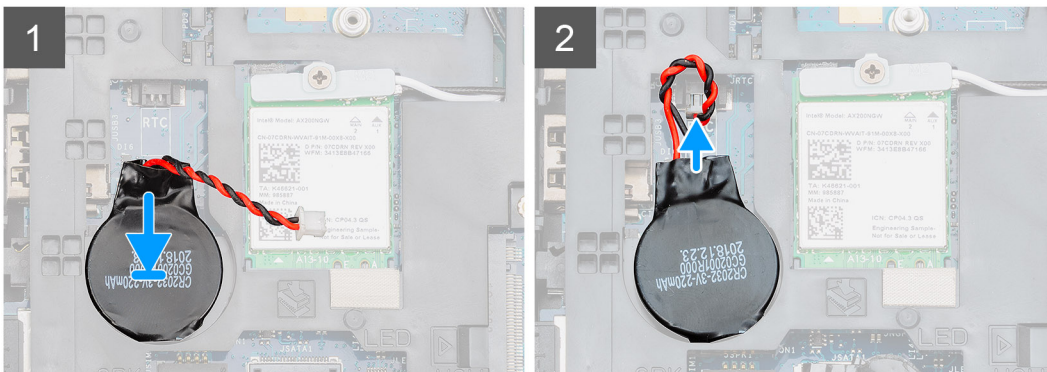
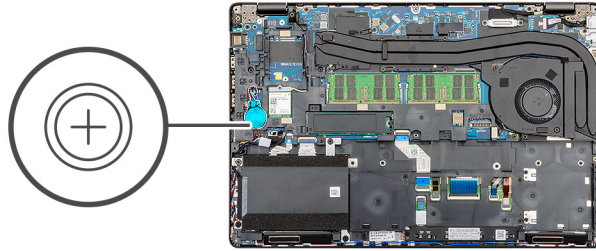
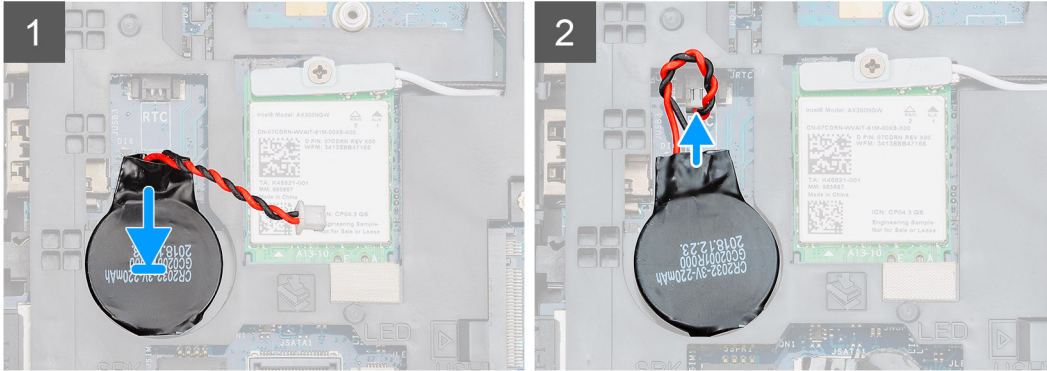
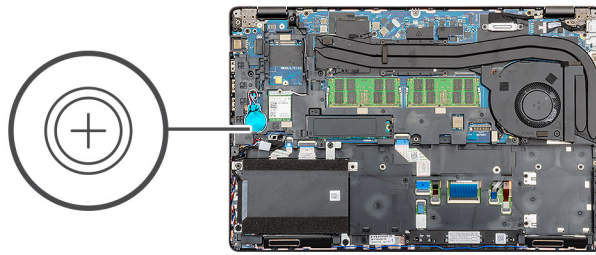

Steps

1. Locate the coin-cell slot on your computer.
2. Adhere the coin-cell on to the slot.
3. Reconnect the coin-cell cable to the system board.

Next steps

1. Install the [battery](#).
2. Install the [base cover](#).
3. Follow the procedure in [After working inside your computer](#).

DC-in port

Removing the DC-in

Prerequisites

1. Follow the procedure in [Before working inside your computer](#).
2. Remove the [base cover](#).
3. Remove the [battery](#).
4. Remove the [heat sink](#).

About this task

The figure indicates the location of the DC-in and provides a visual representation of the removal procedure.



2x
M2x5

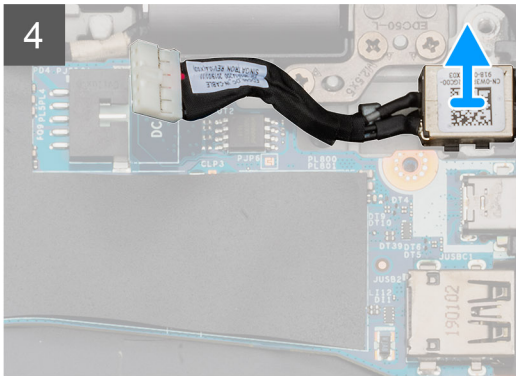
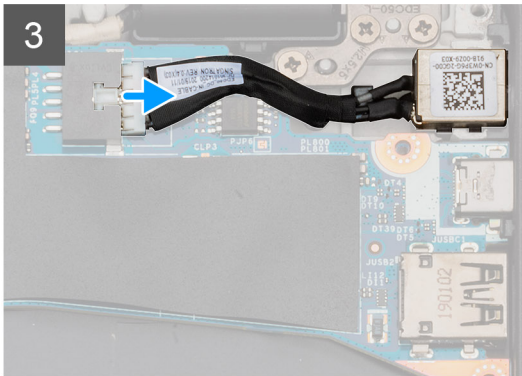
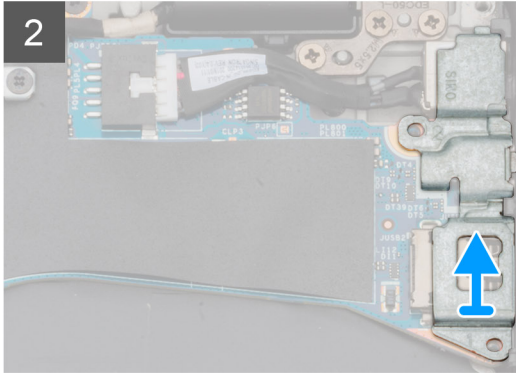
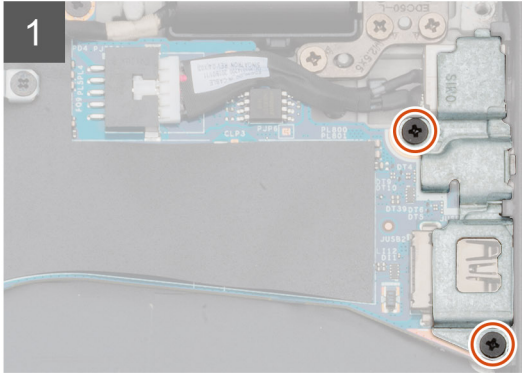
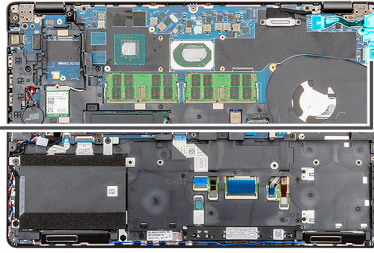
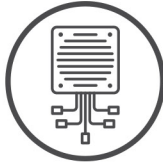

2x
M2x5

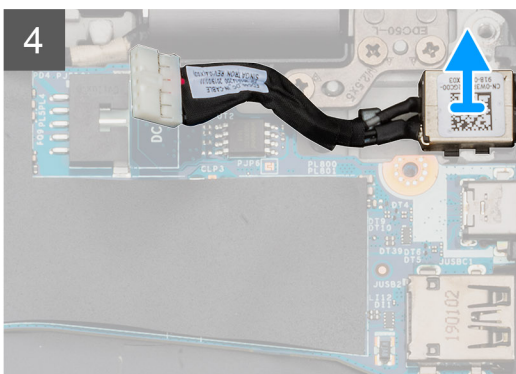
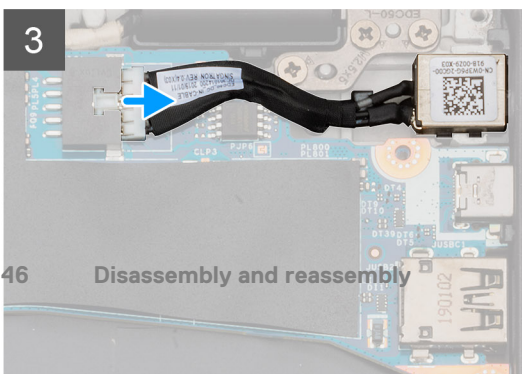
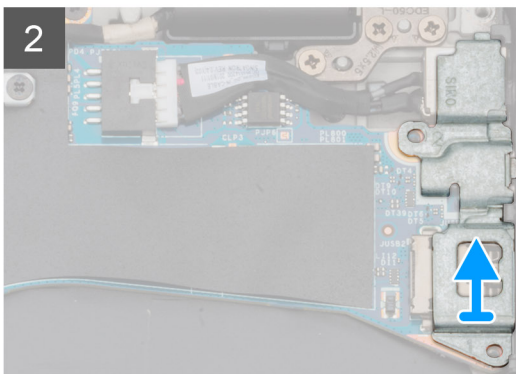
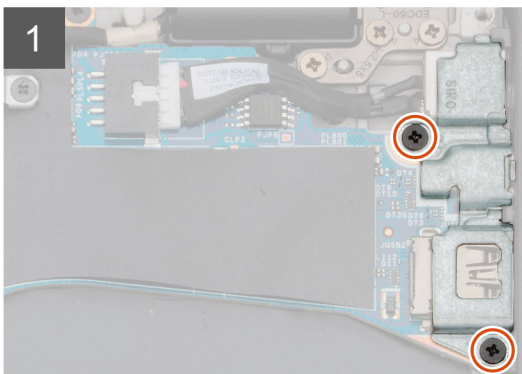
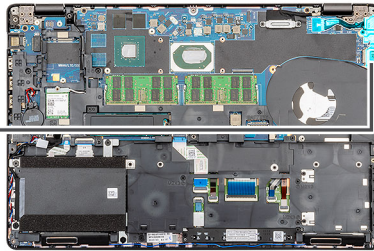
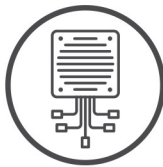

Steps

1. Locate the DC-in port on your computer.
2. Remove the two (M2x5) that secure the DC-in metal bracket.
3. Lift the DC-in metal bracket from the computer.
4. Disconnect the DC-in cable from the system board.
5. Remove the DC-in port from the computer.

Installing the DC-in

Prerequisites

If you are replacing a component, remove the existing component before performing the installation procedure.

About this task

The figure indicates the location of the DC-in and provides a visual representation of the installation procedure.



2x
M2x5

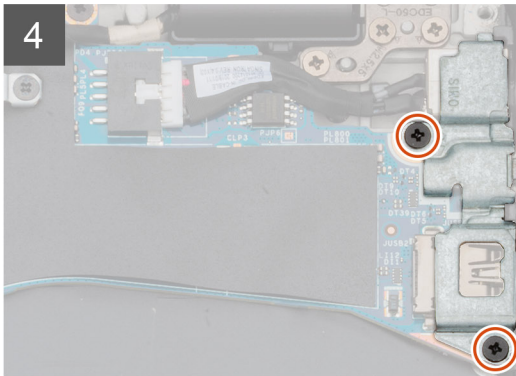
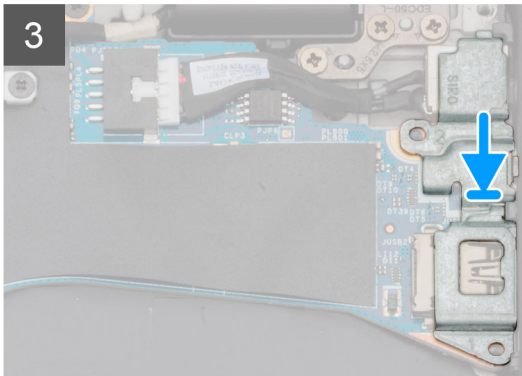
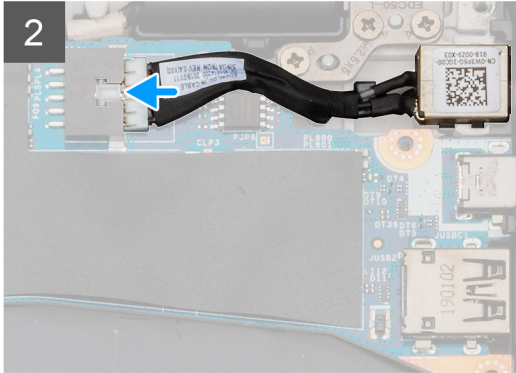
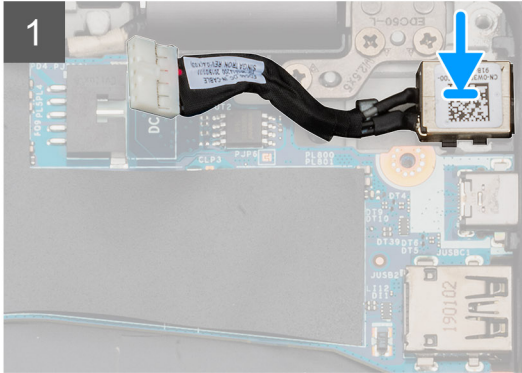
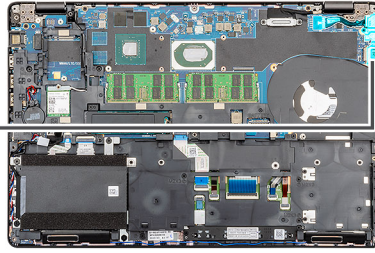
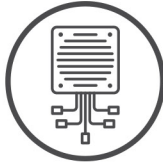

2x
M2x5

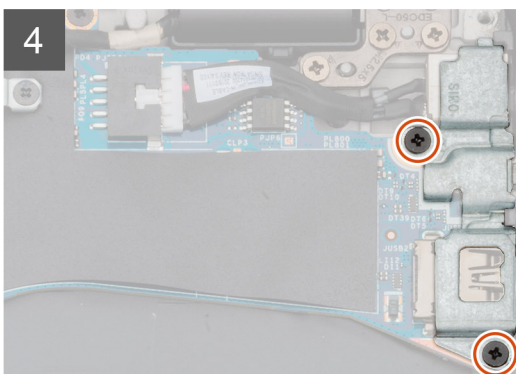
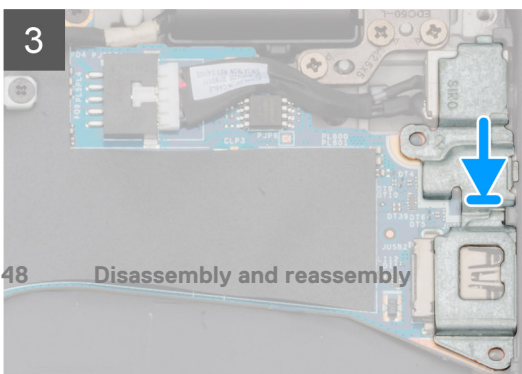
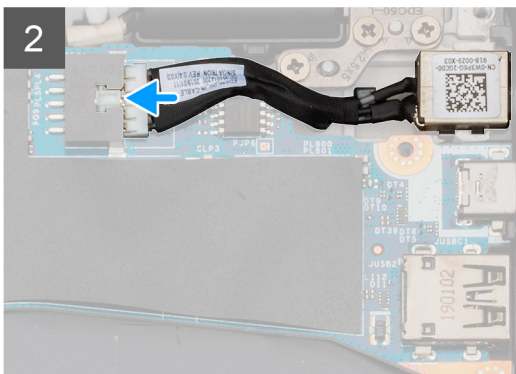
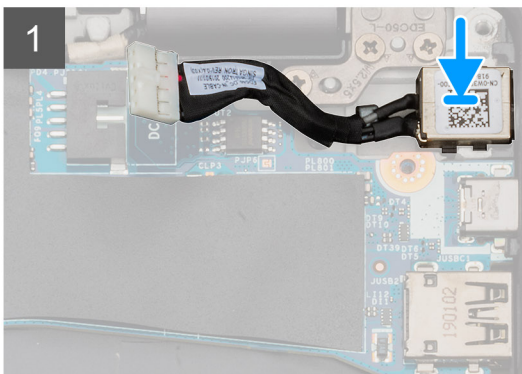
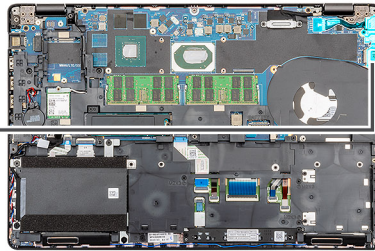
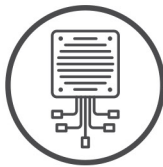

Steps

1. Locate the DC-in slot on your computer.
2. Insert the DC-in port into the slot on your computer.
3. Connect the DC-in cable to the system board.
4. Place the DC-in metal bracket on the DC-in port.
5. Install the two screws (M2x5) that secure the DC-in metal bracket to the system board.

Next steps

1. Install the [heat sink \(for discrete only\)](#).
2. Install the [battery](#).
3. Install the [base cover](#).
4. Follow the procedure in [After working inside your computer](#).

Solid-state drive

Removing the SSD

Prerequisites

1. Follow the procedure in [Before working inside your computer](#).
2. Remove the [base cover](#).
3. Remove the [battery](#).

About this task

The figure indicates the location of the SSD and provides a visual representation of the removal procedure.



2x
M2x3

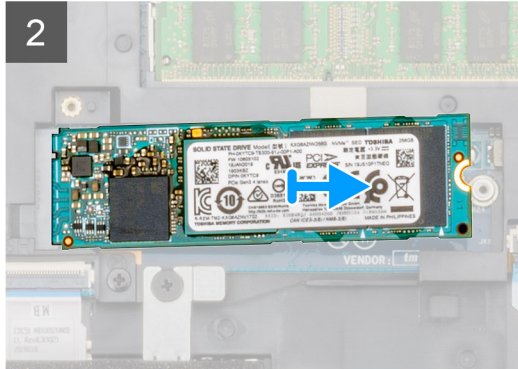
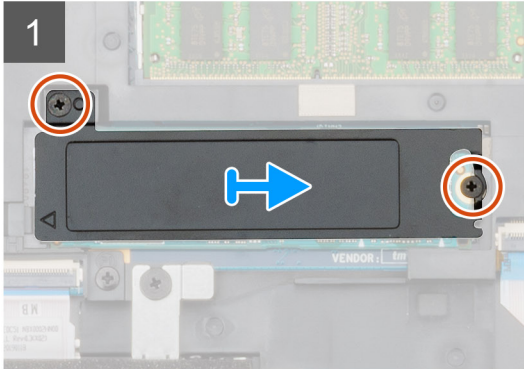
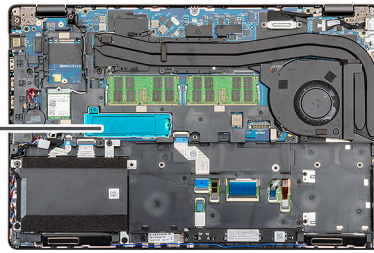

2x
M2x3

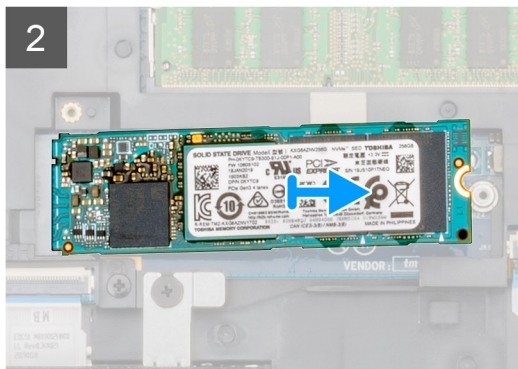
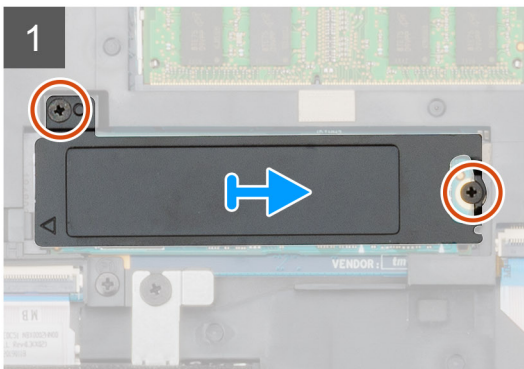
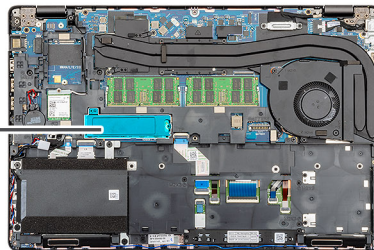

Steps

1. Locate the SSD on your computer.
2. Remove two (M2x3) screws that secure the SSD module to the computer.
3. Remove the SSD thermal plate and slide the SSD out of the computer.

Installing the SSD

Prerequisites

If you are replacing a component, remove the existing component before performing the installation procedure.

About this task

The figure indicates the location of the SSD and provides a visual representation of the installation procedure.



2x
M2x3

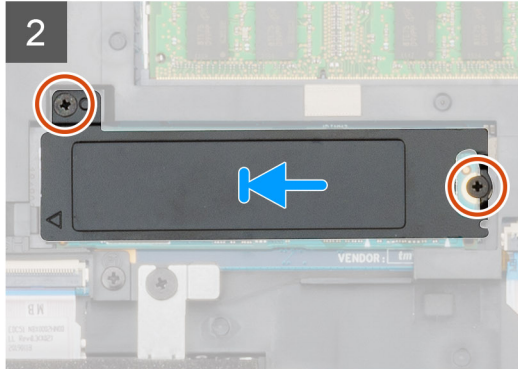
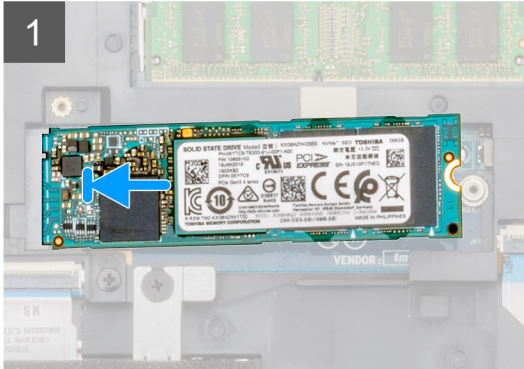
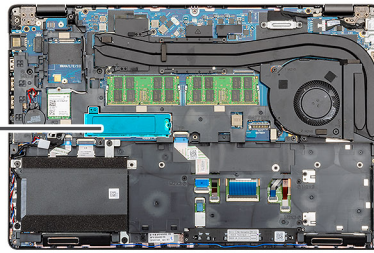

2x
M2x3

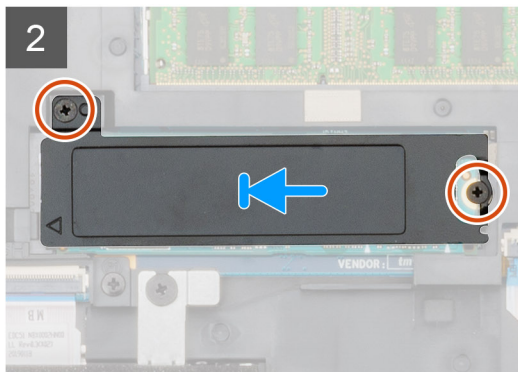
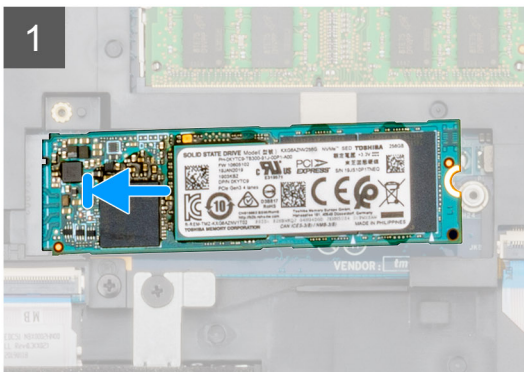
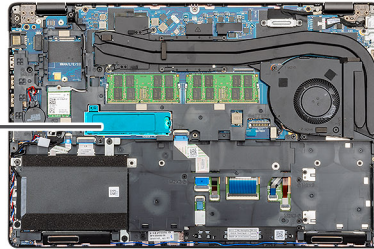

Steps

1. Locate the SSD slot on your computer.
2. Slide the SSD into the slot.
3. Place the SSD thermal plate over the SSD module.
4. Replace the two (M2x3) screws to secure the SSD module to the computer.

Next steps

1. Install the [battery](#).
2. Install the [base cover](#).
3. Follow the procedure in [After working inside your computer](#).

Inner frame

Removing the inner frame

Prerequisites

1. Follow the procedure in [Before working inside your computer](#).
2. Remove the [base cover](#).
3. Remove the [battery](#).
4. Remove the [solid state drive](#).
5. Remove the [HDD](#).
6. Remove the [WLAN card](#).
7. Remove the [WWAN card](#).

About this task

The figure indicates the location of the inner frame and provides a visual representation of the removal procedure.

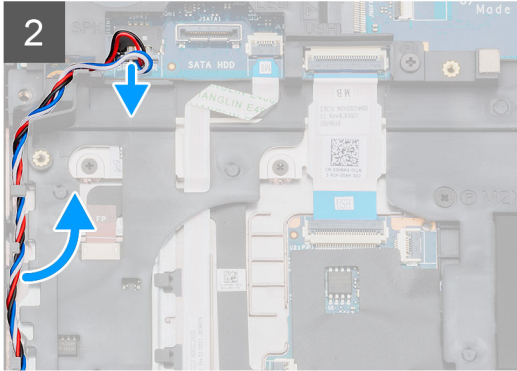
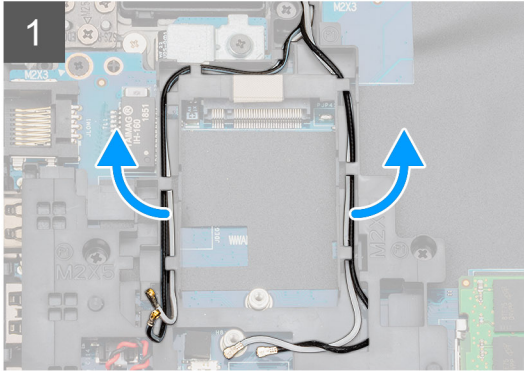
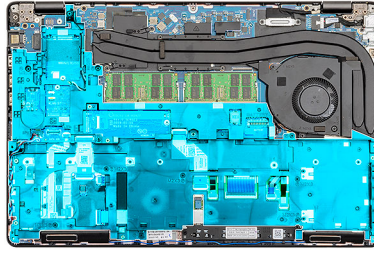

5x
M2x5



6x
M2x3

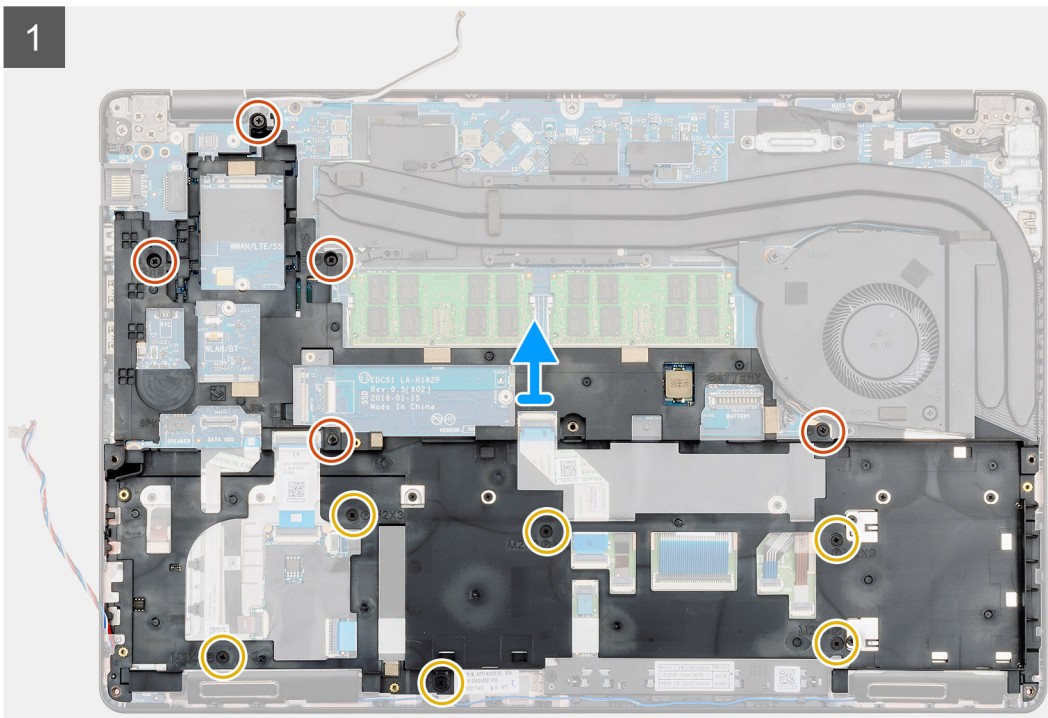
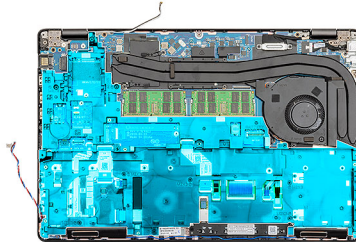

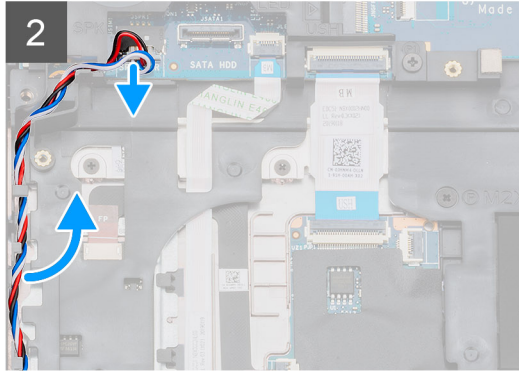
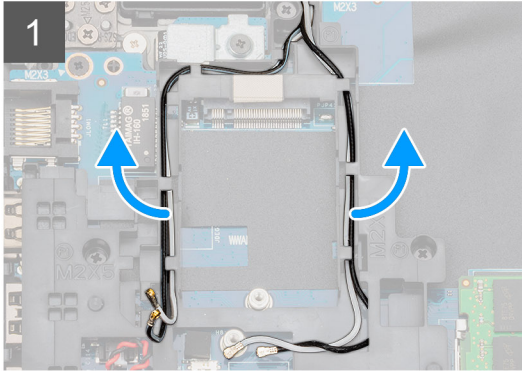
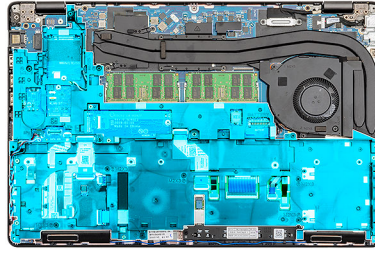

5x
M2x5



6x
M2x3

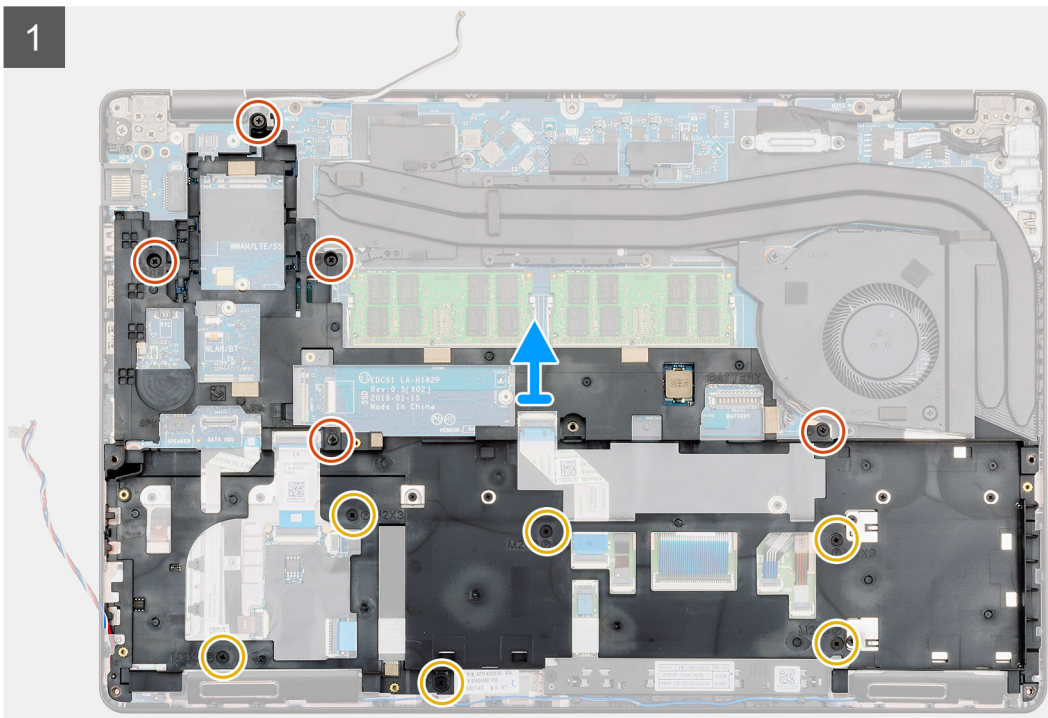
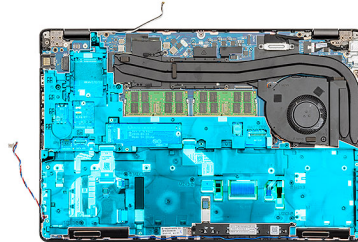

Steps

1. Locate the system board on your computer.
2. Unroute the WWAN and WLAN card cables from the routing clips.
3. Disconnect and unroute the speaker cable.

4. Remove the five (M2x5) and six (M2x3) screws that secure the inner frame to the computer.
5. Lift the inner frame out of the computer.

Installing the inner frame

Prerequisites

If you are replacing a component, remove the existing component before performing the installation procedure.

About this task

The figure indicates the location of the inner frame and provides a visual representation of the installation procedure.



5x
M2x5



6x
M2x3

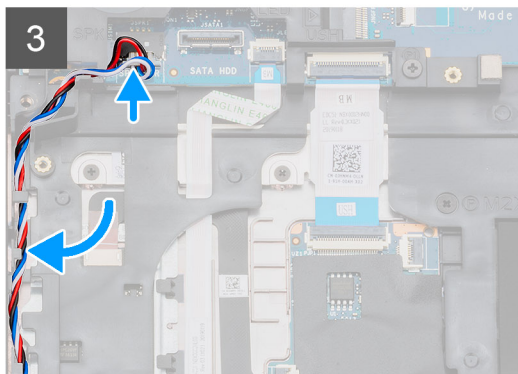
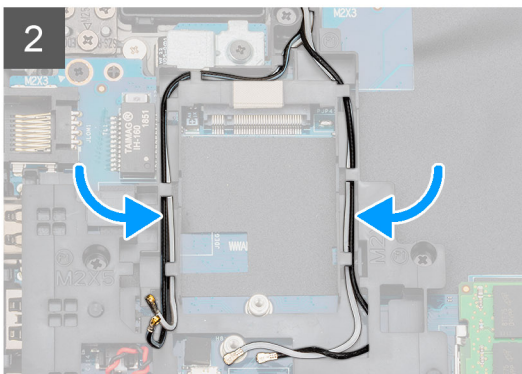
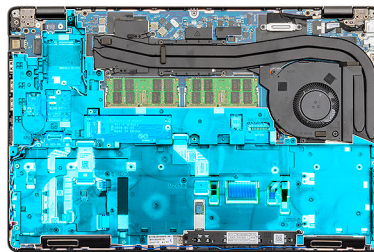
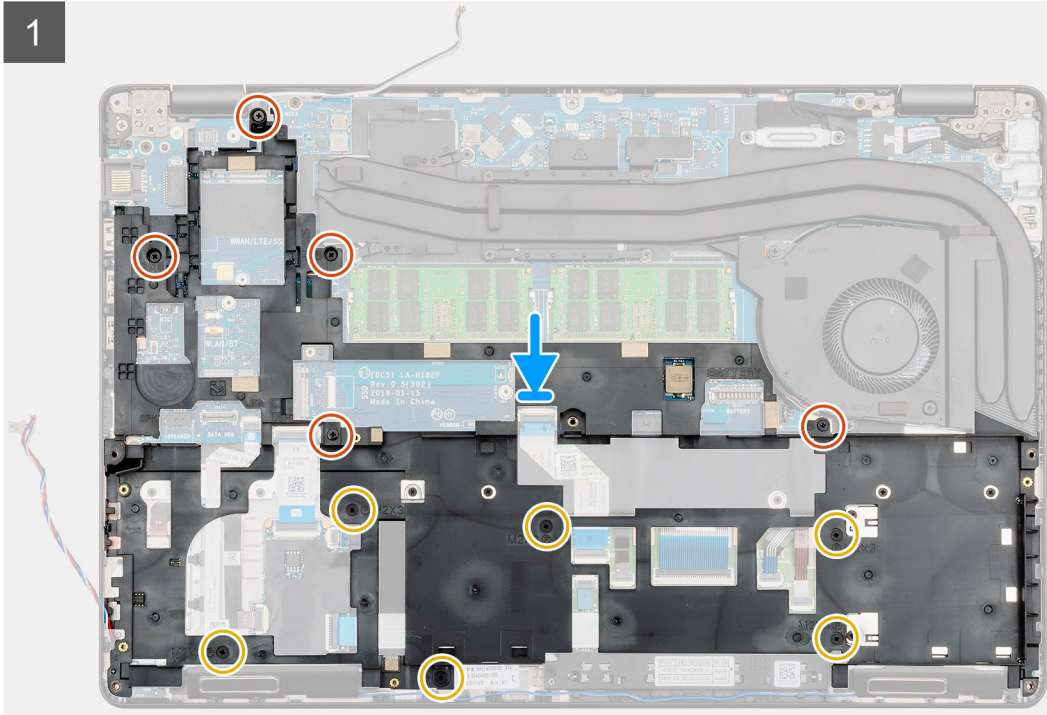
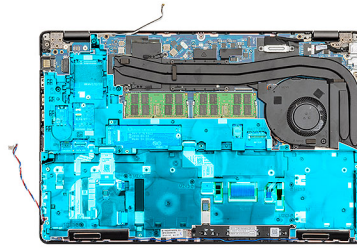



5x
M2x5



6x
M2x3

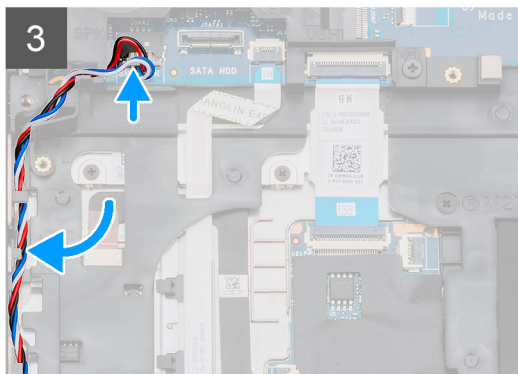
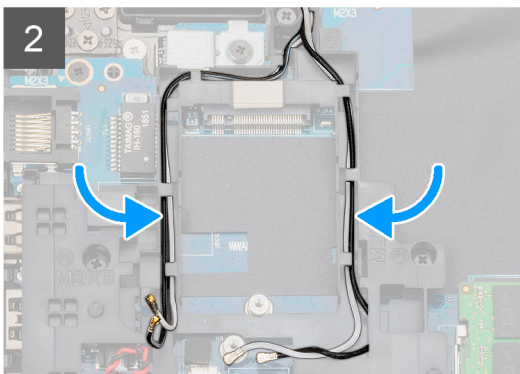
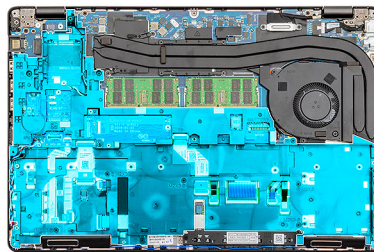
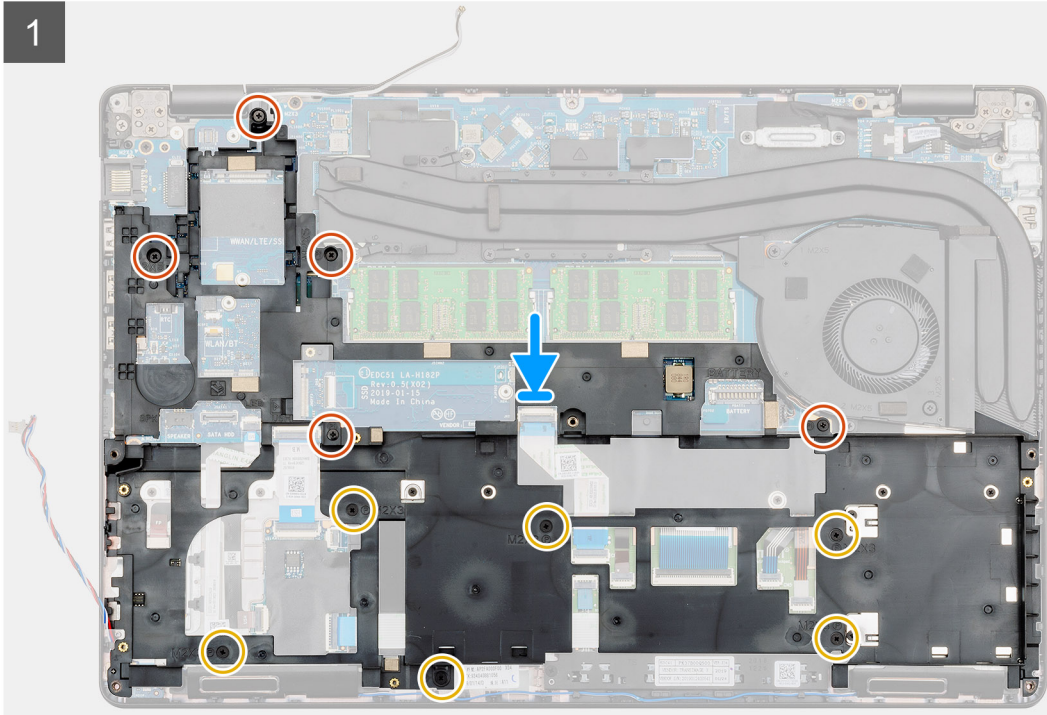
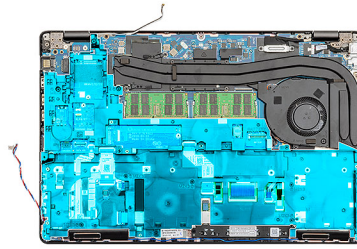

Steps

1. Locate the Inner frame slot on your computer.
2. Align and place the inner frame into the slot on your computer.
3. Install the five (M2x5) and six (M2x3) that secure the inner frame to the computer.

4. Route the WWAN and WLAN card cable through the retention clips on the frame.
5. Route the Speaker through the retention clips and connect it to the system board.

Next steps

1. Install the [WWAN card](#).
2. Install the [WLAN card](#).
3. Install the [HDD](#).
4. Install the [solid state drive](#).
5. Install the [battery](#).
6. Install the [base cover](#).
7. Follow the procedure in [After working inside your computer](#).

Touchpad buttons

Touchpad buttons

Removing the touchpad buttons

Prerequisites

1. Follow the procedure in [Before working inside your computer](#).
2. Remove the [base cover](#).
3. Remove the [battery](#).
4. Remove the [solid state drive](#).
5. Remove the [HDD](#).
6. Remove the [WLAN card](#).
7. Remove the [WWAN card](#).
8. Remove the [inner frame](#).

About this task

The figure indicates the location of the touchpad buttons and provides a visual representation of the removal procedure.



2x
M2x3

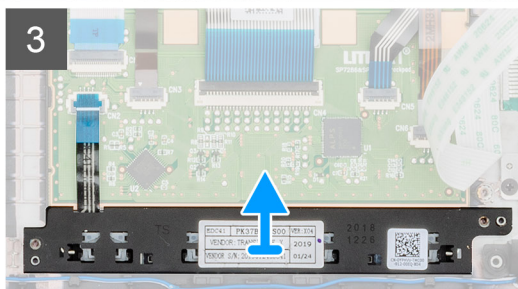
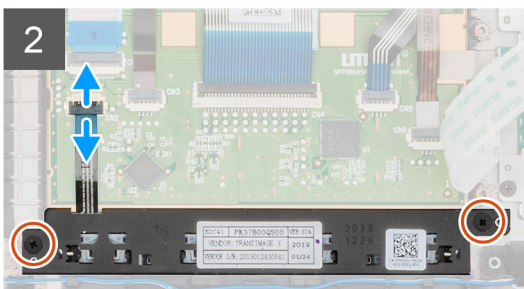
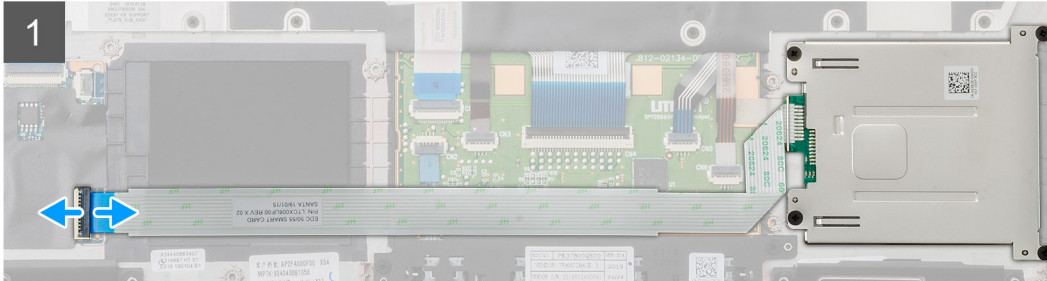
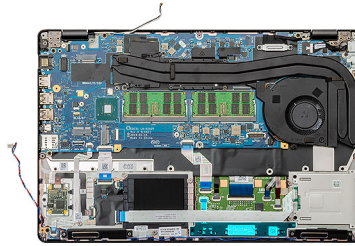

2x
M2x3

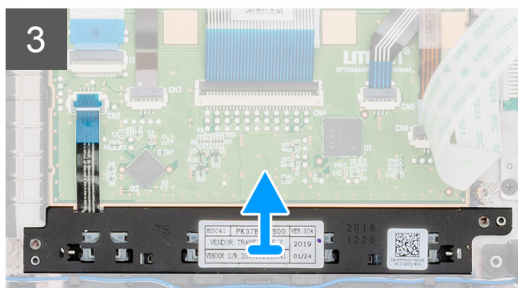
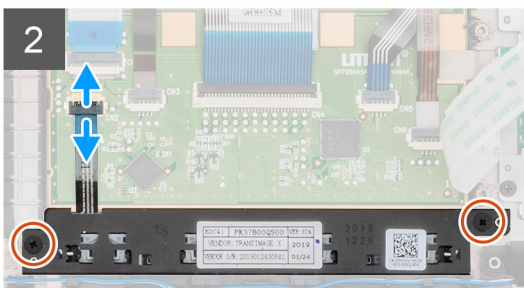
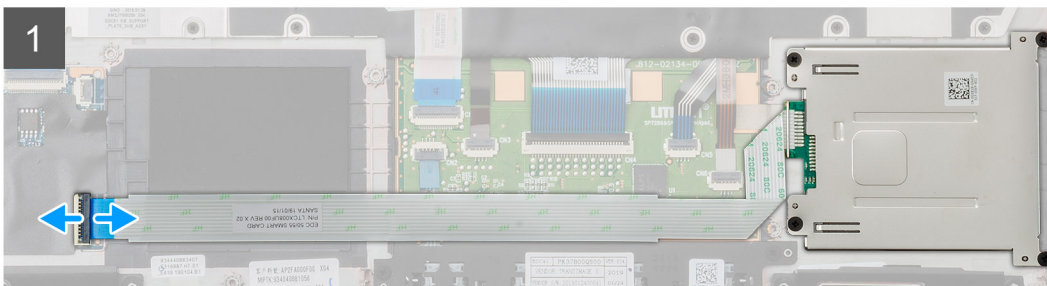
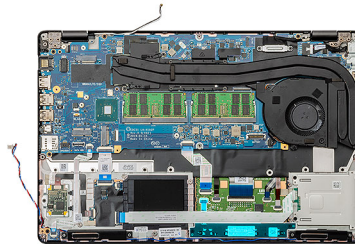

Steps

1. Locate the touchpad buttons board on your computer.
2. Open the latch and disconnect the smart card reader board cable from the system board.

3. Open the latch and disconnect the touchpad buttons cable from the connector.
4. Remove the two (M2x3) screws that secure the touchpad buttons to the palmrest.
5. Lift the touchpad buttons out of the computer.

Installing the touchpad buttons

Prerequisites

If you are replacing a component, remove the existing component before performing the installation procedure.

About this task

The figure indicates the location of the touchpad buttons and provides a visual representation of the installation procedure.



2x
M2x3

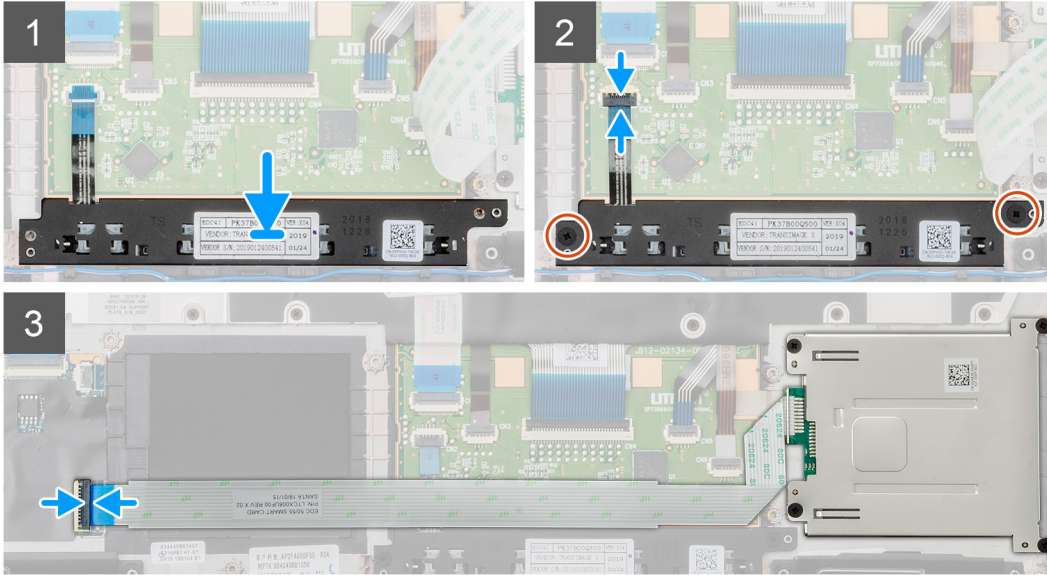
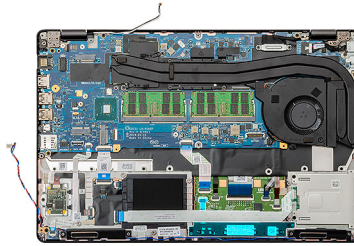

2x
M2x3

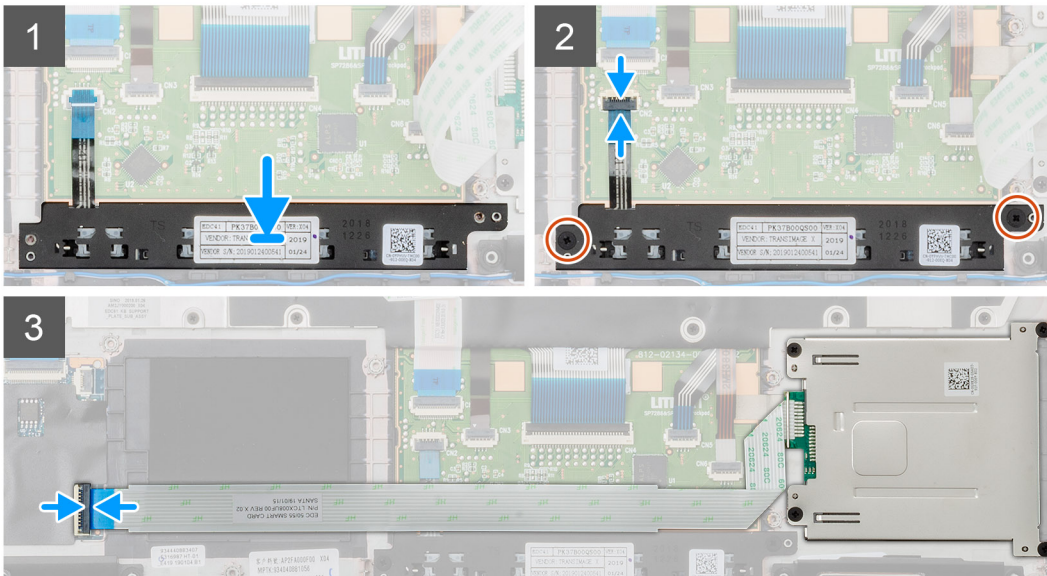
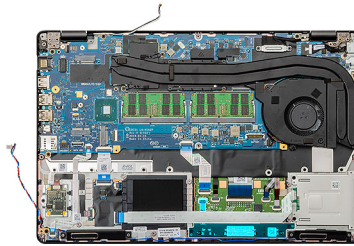

Steps

1. Locate the touchpad buttons slot on your computer.
2. Align and place the touchpad buttons into the slot on your computer.

3. Connect the touchpad buttons cable to the connector on the computer and secure the latch.
4. Install the two (M2x3) screws to secure the touchpad buttons on to the computer.
5. Connect the smart card reader cable to its connector and secure the latch.

Next steps

1. Install the [inner frame](#).
2. Install the [WWAN card](#).
3. Install the [WLAN card](#).
4. Install the [HDD](#).
5. Install the [solid state drive](#).
6. Install the [battery](#).
7. Install the [base cover](#).
8. Follow the procedure in [After working inside your computer](#).

SmartCard reader

Removing the smart card reader board

Prerequisites

1. Follow the procedure in [Before working inside your computer](#).
2. Remove the [base cover](#).
3. Remove the [battery](#).
4. Remove the [solid state drive](#).
5. Remove the [HDD](#).
6. Remove the [WLAN card](#).
7. Remove the [WWAN card](#).
8. Remove the [inner frame](#).

About this task

The figure indicates the location of the smart card reader board and provides a visual representation of the removal procedure.



4x
M2x3

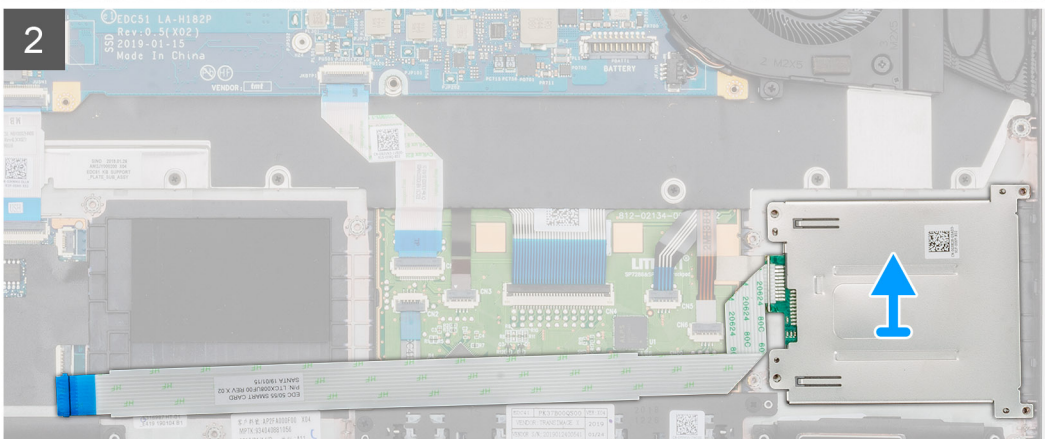
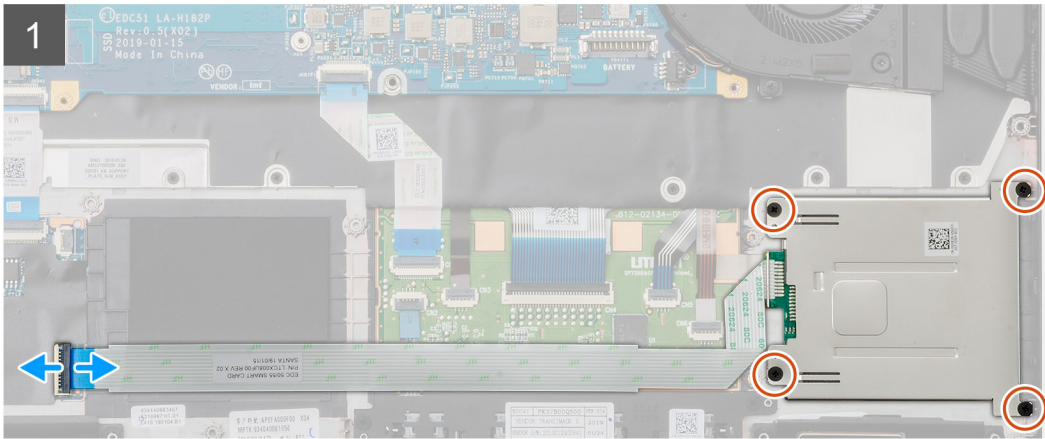
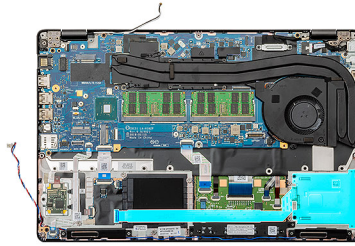

4x
M2x3

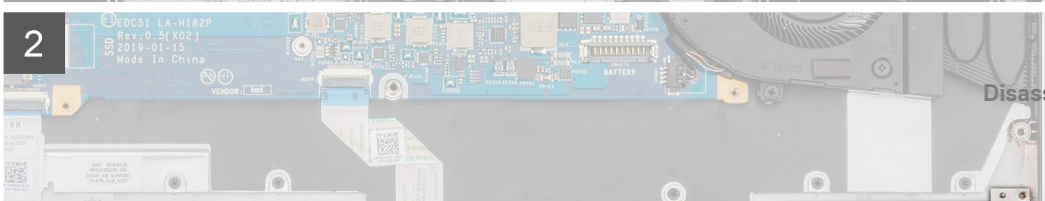
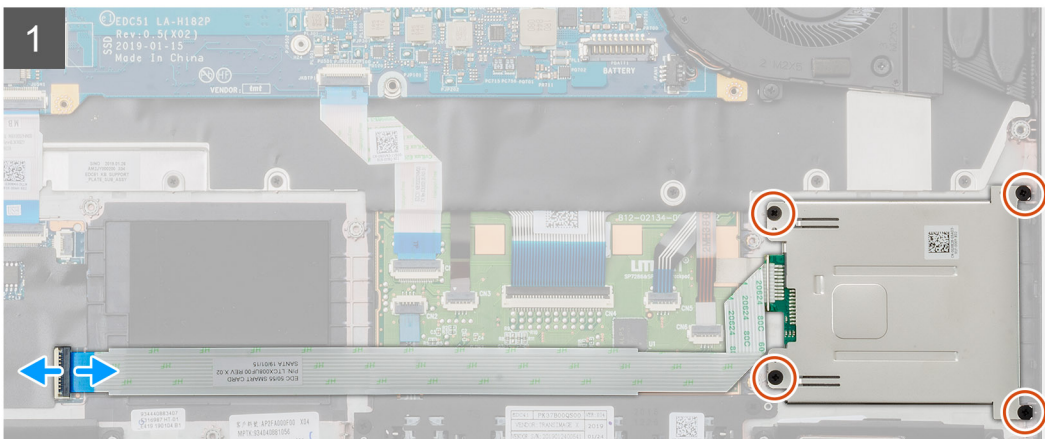
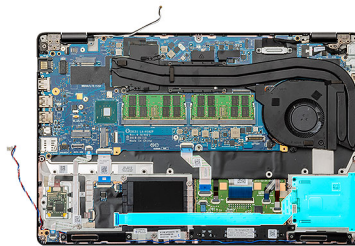

Steps

1. Locate the Smart card reader board on your computer.
2. Open the latch and disconnect the Smart card reader board cable from the system board.
3. Remove the four (M2X3) screws that secure the smart card reader board to the computer.
4. Lift the smart card reader module out of the computer.

Installing the smart card reader board

Prerequisites

If you are replacing a component, remove the existing component before performing the installation procedure.

About this task

The figure indicates the location of the smart card reader board and provides a visual representation of the installation procedure.



4x
M2x3

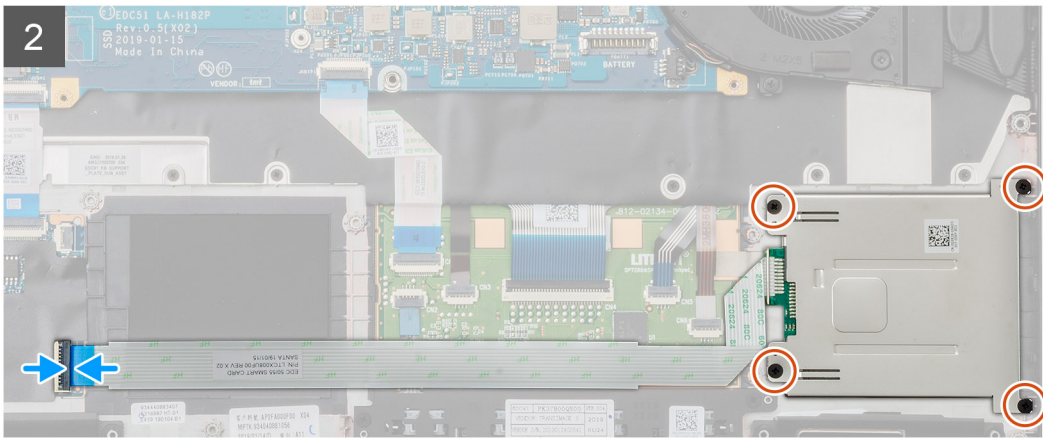
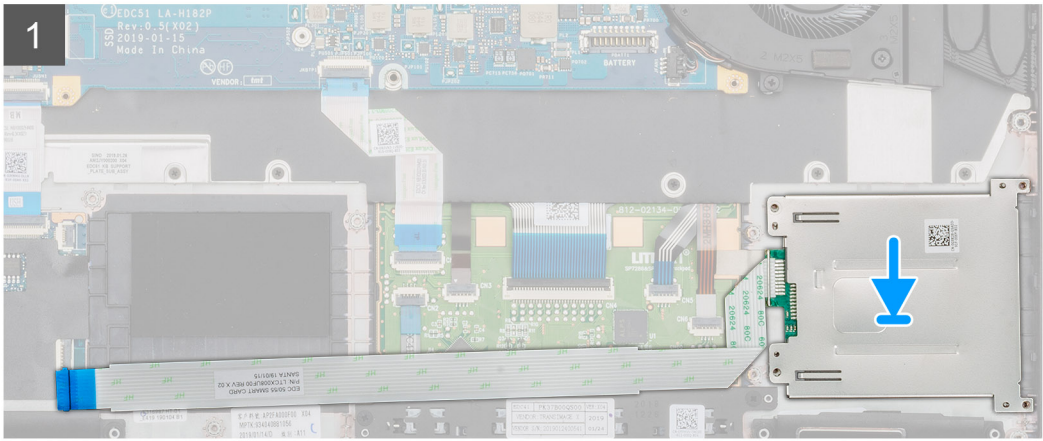
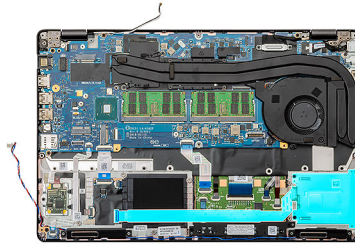

4x
M2x3

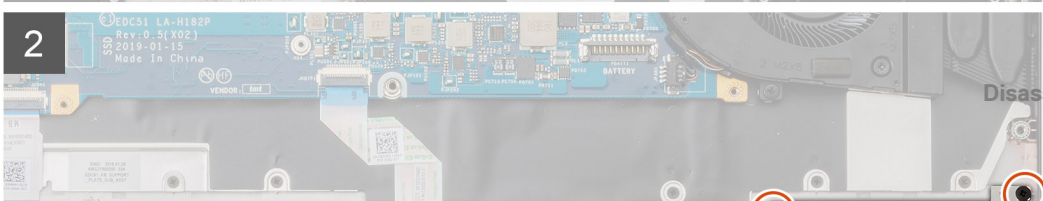
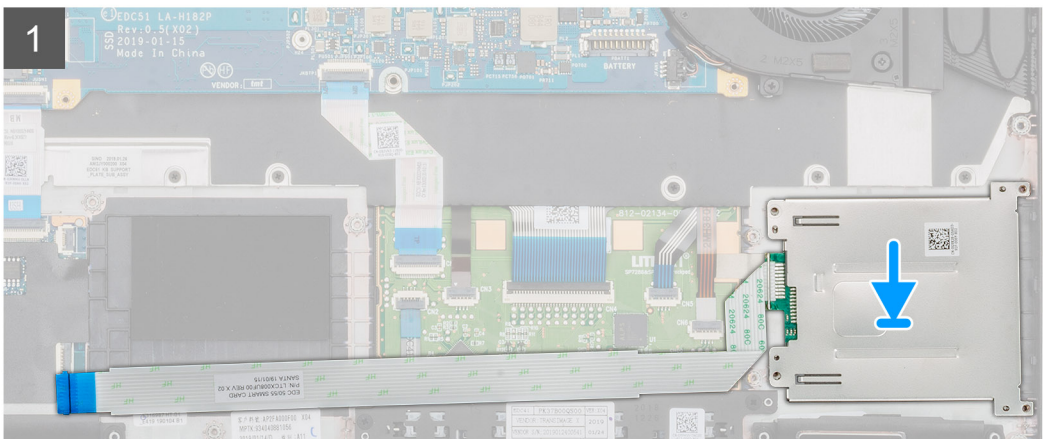
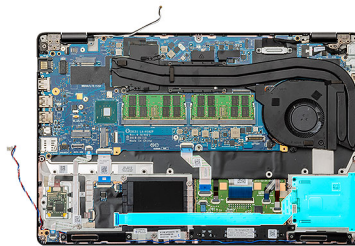

Steps

1. Locate the smart card reader board slot on your computer.
2. Align and place the smart card reader board into the slot on your computer.
3. Install the four (M2X3) screws that secure the smart card reader board to the computer.
4. Connect the smart card reader cable on to the connector on the system board and lock the latch.

Next steps

1. Install the [inner frame](#).
2. Install the [WWAN card](#).
3. Install the [WLAN card](#).
4. Install the [HDD](#).
5. Install the [solid state drive](#).
6. Install the [battery](#).
7. Install the [base cover](#).
8. Follow the procedure in [After working inside your computer](#).

Touchpad buttons

Removing the touchpad buttons

Prerequisites

1. Follow the procedure in [Before working inside your computer](#).
2. Remove the [base cover](#).
3. Remove the [battery](#).
4. Remove the [solid state drive](#).
5. Remove the [HDD](#).
6. Remove the [WLAN card](#).
7. Remove the [WWAN card](#).
8. Remove the [inner frame](#).

About this task

The figure indicates the location of the touchpad buttons and provides a visual representation of the removal procedure.



2x
M2x3

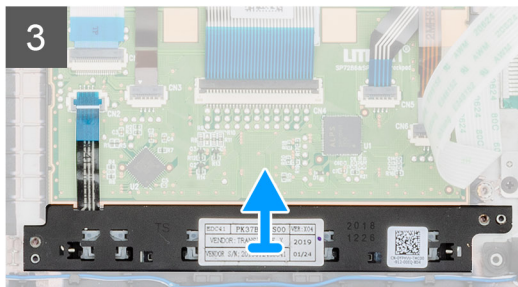
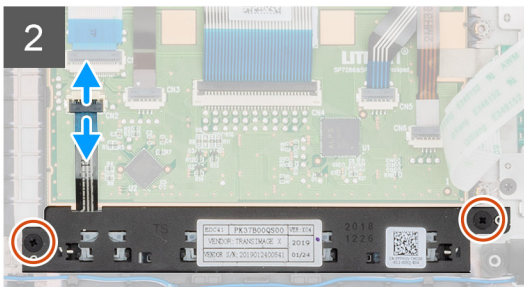
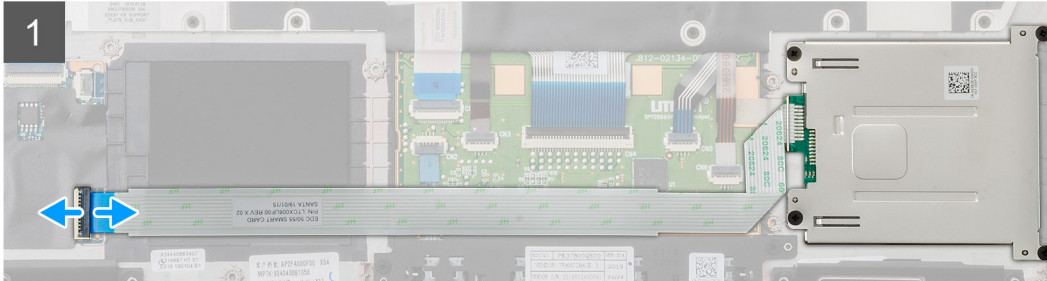
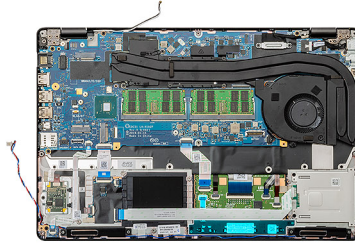

2x
M2x3

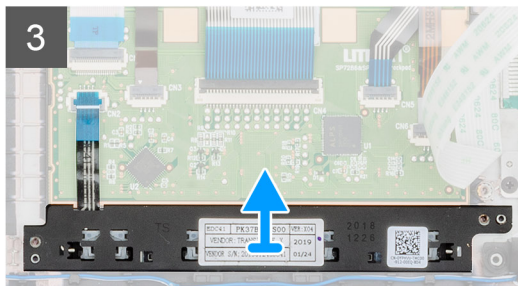
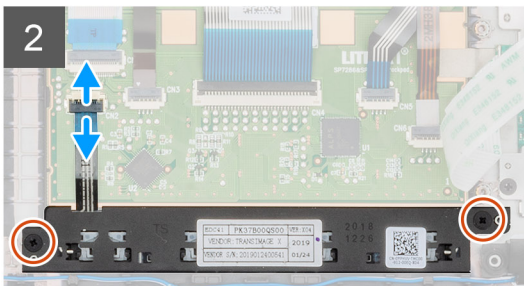
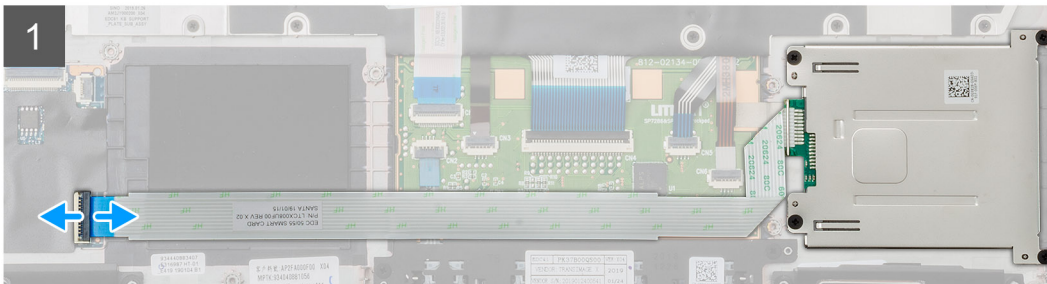
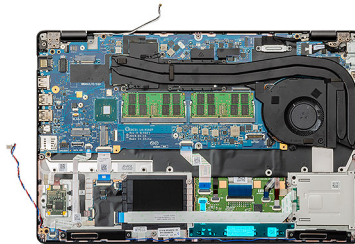

Steps

1. Locate the touchpad buttons board on your computer.
2. Open the latch and disconnect the smart card reader board cable from the system board.

3. Open the latch and disconnect the touchpad buttons cable from the connector.
4. Remove the two (M2x3) screws that secure the touchpad buttons to the palmrest.
5. Lift the touchpad buttons out of the computer.

Installing the touchpad buttons

Prerequisites

If you are replacing a component, remove the existing component before performing the installation procedure.

About this task

The figure indicates the location of the touchpad buttons and provides a visual representation of the installation procedure.



2x
M2x3

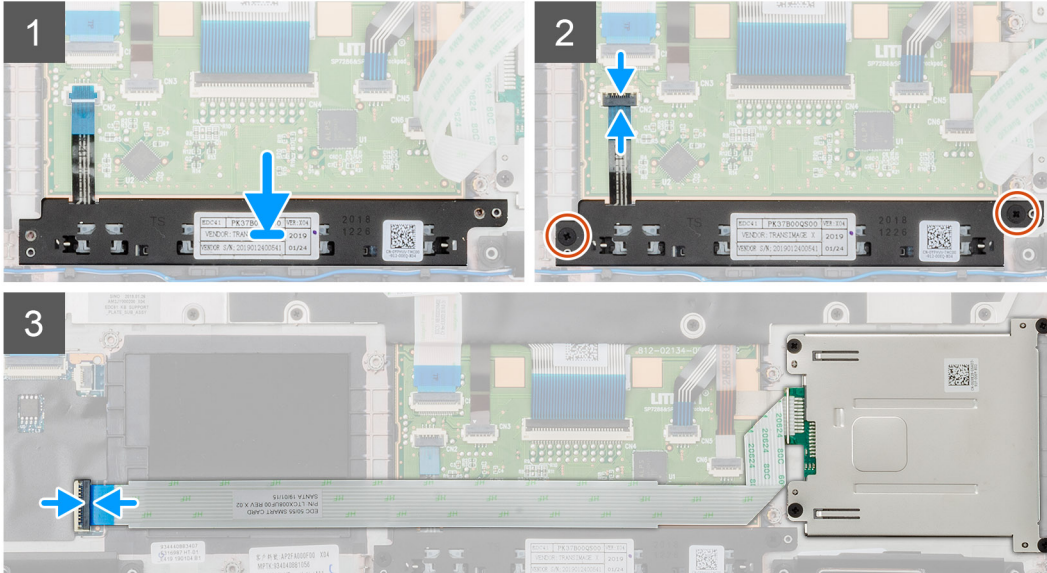
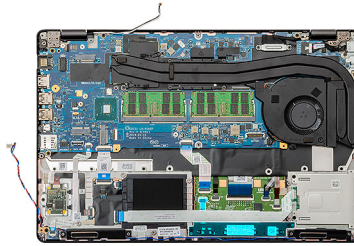

2x
M2x3

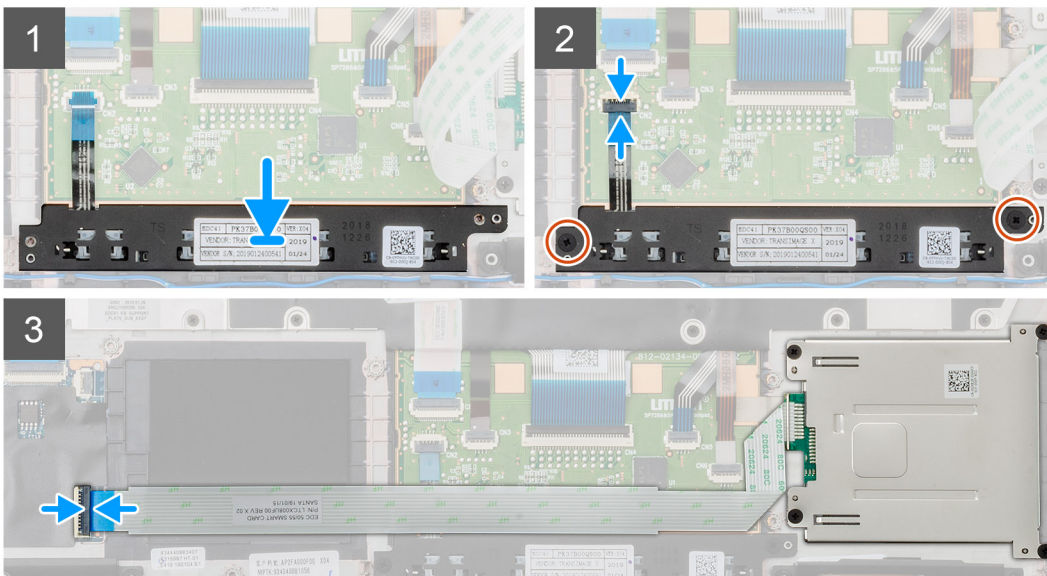
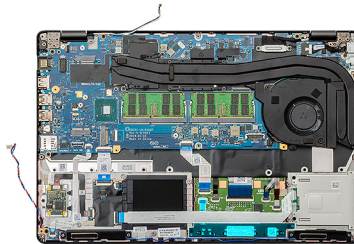

Steps

1. Locate the touchpad buttons slot on your computer.
2. Align and place the touchpad buttons into the slot on your computer.

3. Connect the touchpad buttons cable to the connector on the computer and secure the latch.
4. Install the two (M2x3) screws to secure the touchpad buttons on to the computer.
5. Connect the smart card reader cable to its connector and secure the latch.

Next steps

1. Install the [inner frame](#).
2. Install the [WWAN card](#).
3. Install the [WLAN card](#).
4. Install the [HDD](#).
5. Install the [solid state drive](#).
6. Install the [battery](#).
7. Install the [base cover](#).
8. Follow the procedure in [After working inside your computer](#).

LED board

Removing the LED board

Prerequisites

1. Follow the procedure in [Before working inside your computer](#).
2. Remove the [base cover](#).
3. Remove the [battery](#).
4. Remove the [solid state drive](#).
5. Remove the [HDD](#).
6. Remove the [WLAN card](#).
7. Remove the [WWAN card](#).
8. Remove the [inner frame](#).

About this task

The figure indicates the location of the LED board and provides a visual representation of the removal procedure.



1x
M2x3

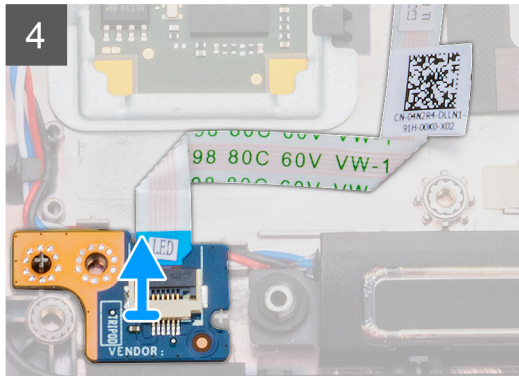
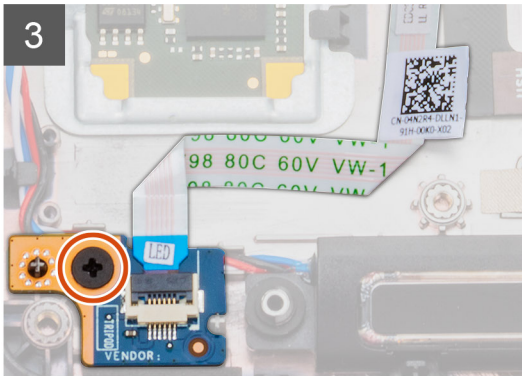
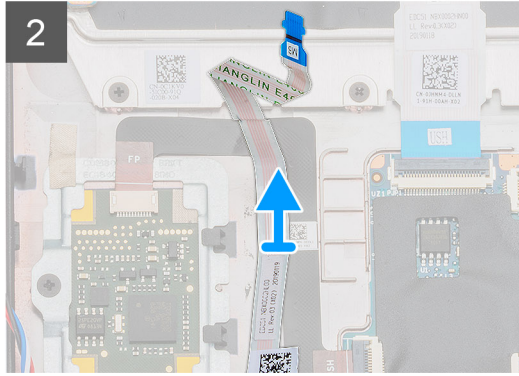
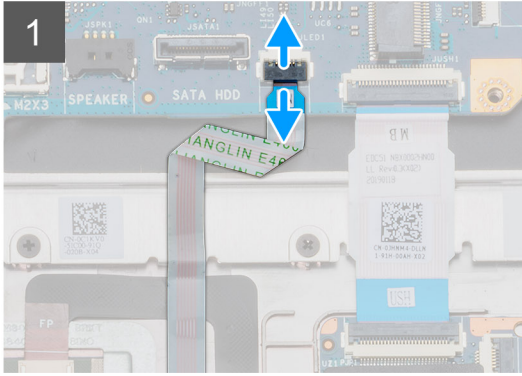
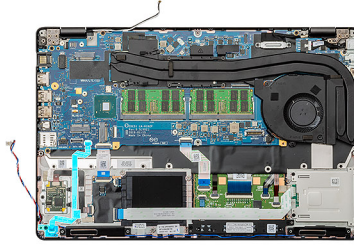

1x
M2x3

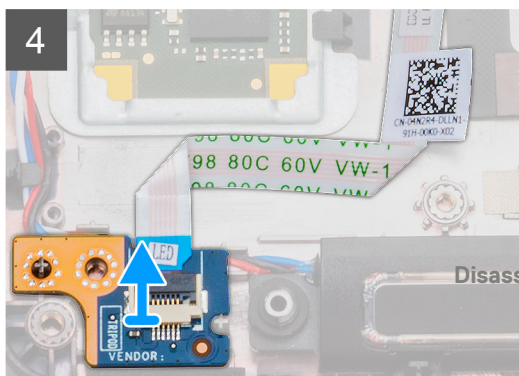
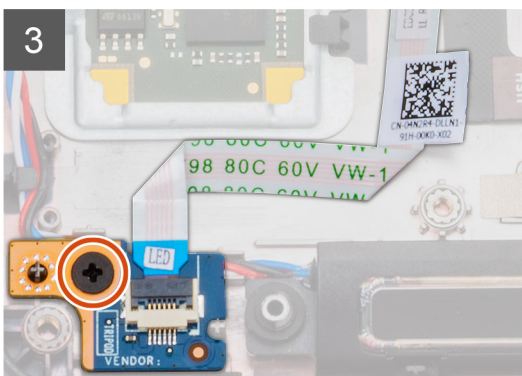
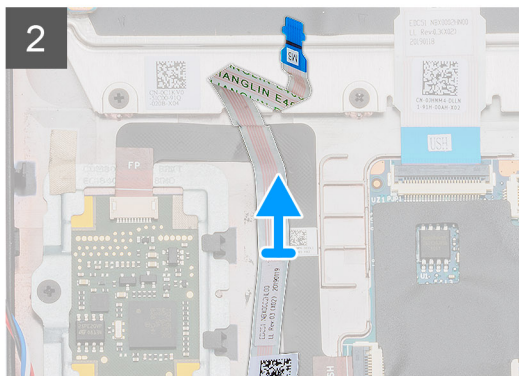
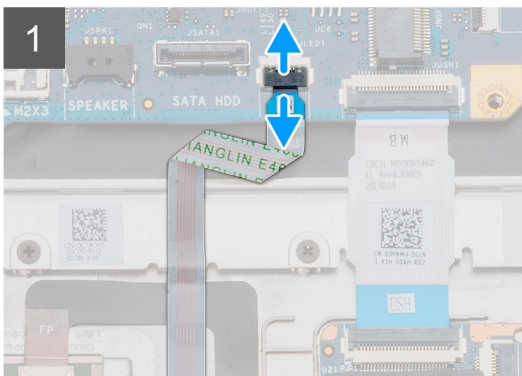
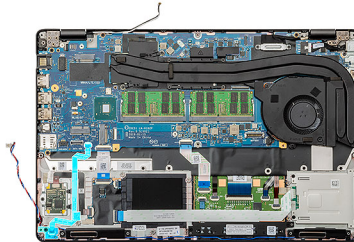

Steps

1. Locate the LED board on your computer.
2. Open the latch and disconnect the LED board cable from the system board.
3. Peel back the LED board cable.

 **NOTE: The LED board cable is secured to the computer by an adhesive strip.**

4. Remove the single (M2x3) screw that secures the LED board to the computer.
5. Lift the LED board out of the computer.

Installing the LED board

Prerequisites

If you are replacing a component, remove the existing component before performing the installation procedure.

About this task

The figure indicates the location of the LED board and provides a visual representation of the installation procedure.



1x
M2x3

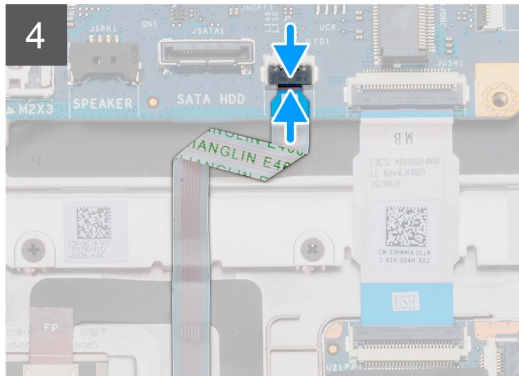
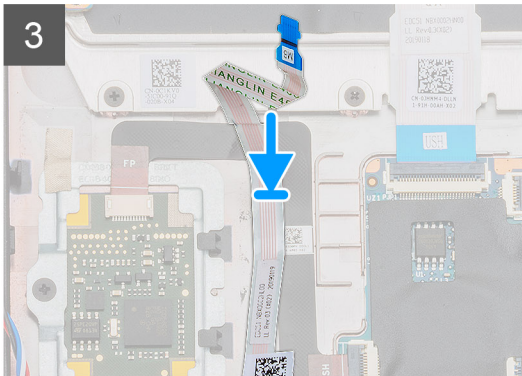
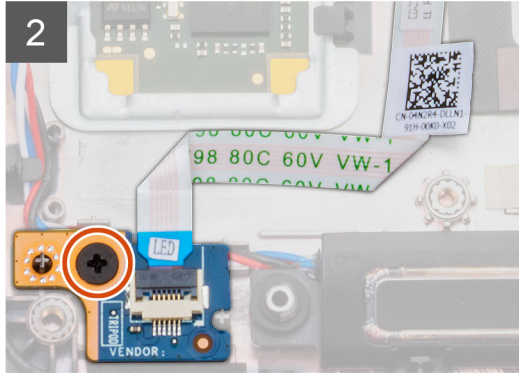
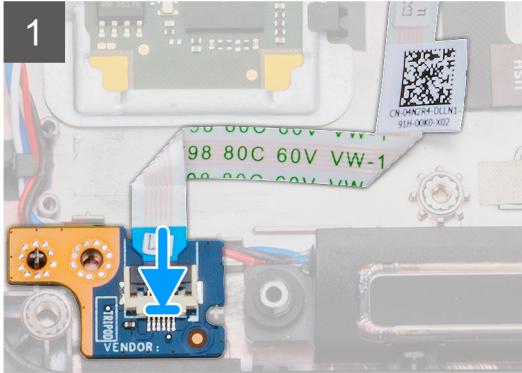
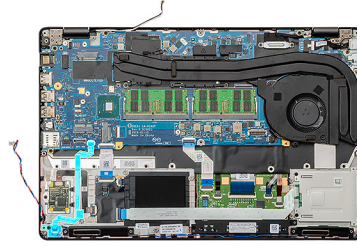

1x
M2x3

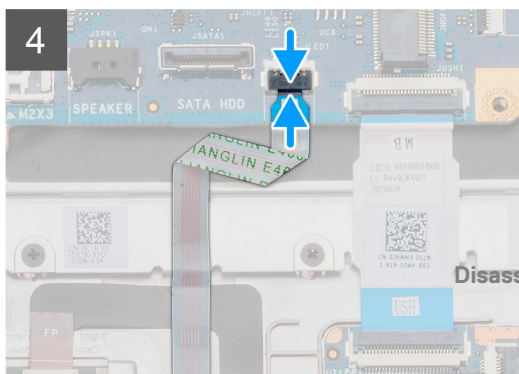
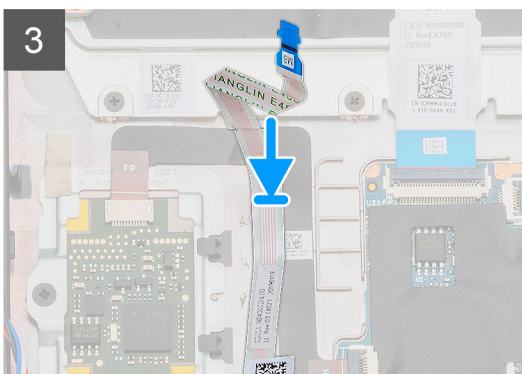
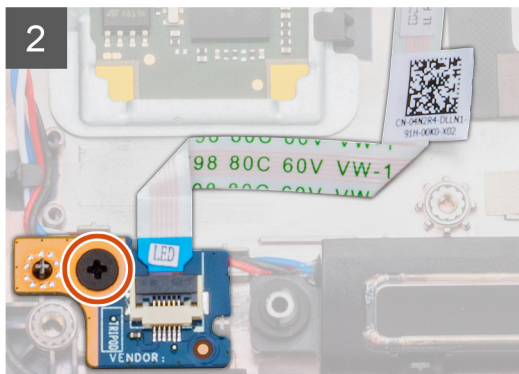
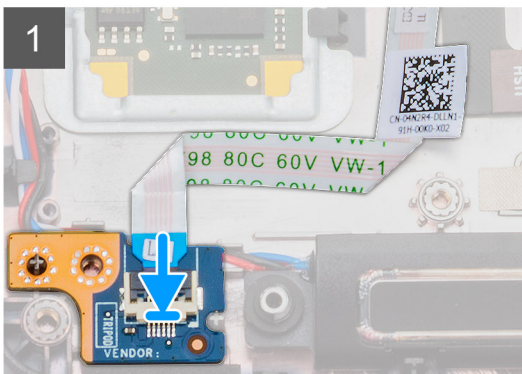
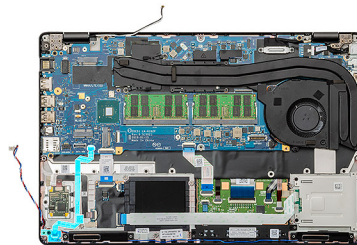

Steps

1. Locate the LED board slot on your computer.
2. Align and place the LED board on the slot on your computer.
3. Install the single (M2x3) screw that secures the LED board to the computer.
4. Adhere the LED board cable to the adhesive strip on the computer.
5. Connect the LED board cable to the connector on the system board.

Next steps

1. Install the [inner frame](#).
2. Install the [WWAN card](#).
3. Install the [WLAN card](#).
4. Install the [HDD](#).
5. Install the [solid state drive](#).
6. Install the [battery](#).
7. Install the [base cover](#).
8. Follow the procedure in [After working inside your computer](#).

Speakers

Removing the speakers

Prerequisites

1. Follow the procedure in [Before working inside your computer](#).
2. Remove the [base cover](#).
3. Remove the [battery](#).
4. Remove the [solid state drive](#).
5. Remove the [HDD](#).
6. Remove the [WLAN card](#).
7. Remove the [WWAN card](#).
8. Remove the [inner frame](#).
9. Remove the [LED board](#).

About this task

The figure indicates the location of the speakers and provides a visual representation of the removal procedure.

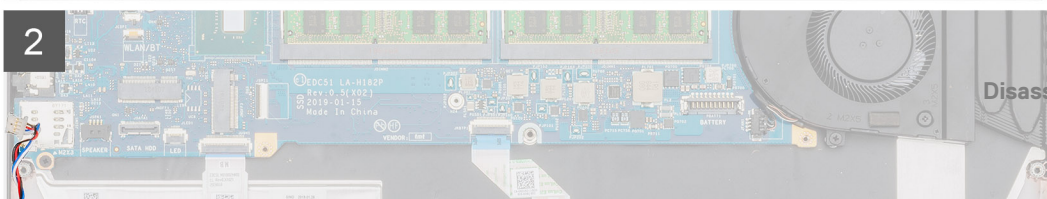
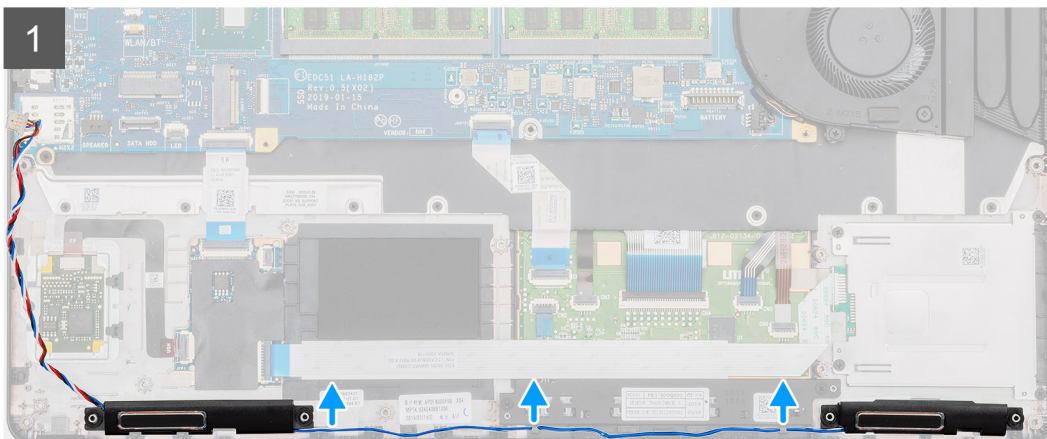
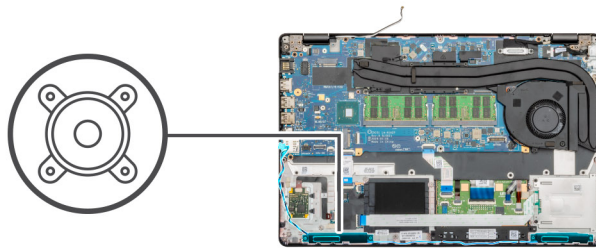
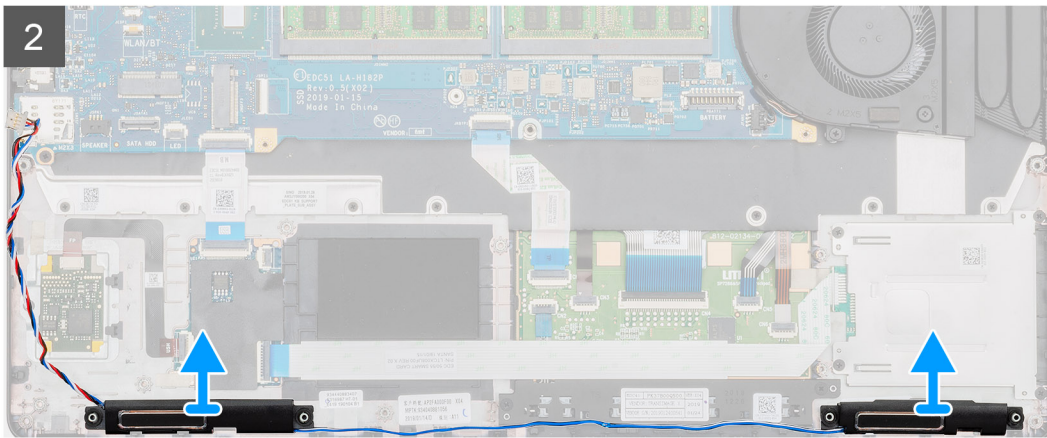
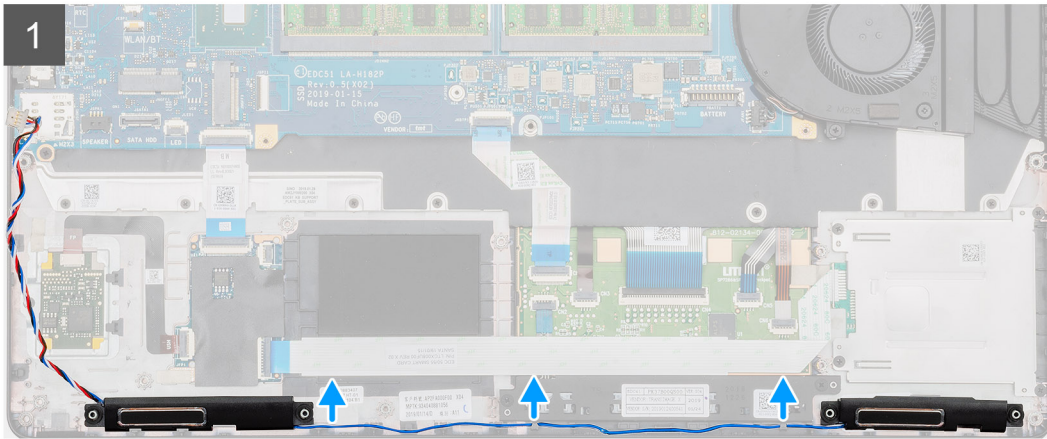
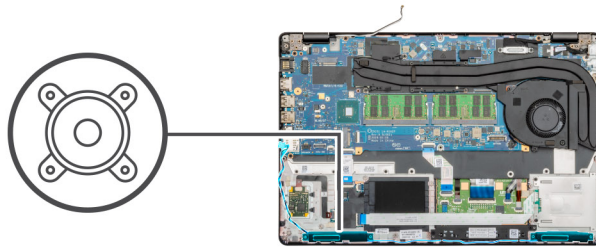

Steps

1. Locate the speakers on your computer.
2. Unroute the speaker cables from the retention clips on the computer.
3. Lift the speakers out of the computer.

Installing the speakers

Prerequisites

If you are replacing a component, remove the existing component before performing the installation procedure.

About this task

The figure indicates the location of the speakers and provides a visual representation of the installation procedure.

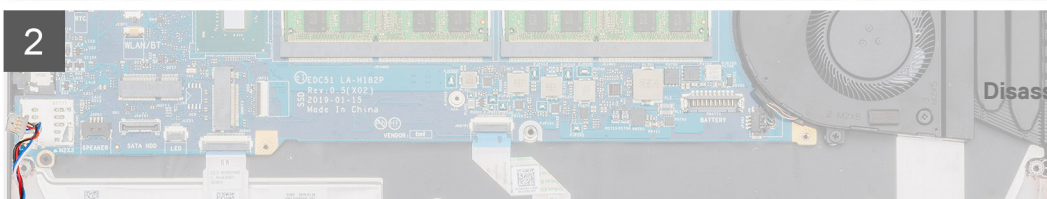
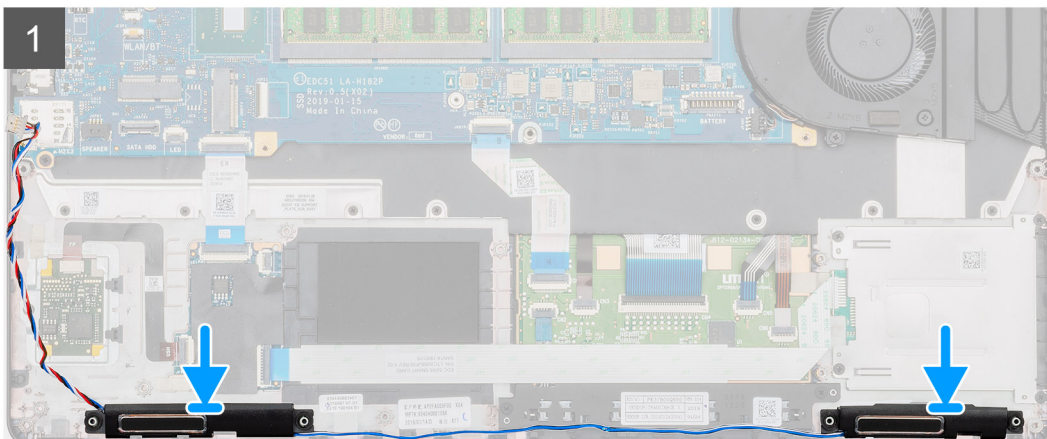
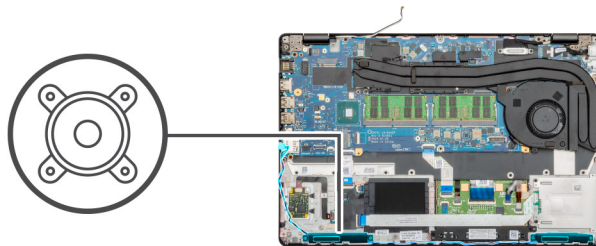
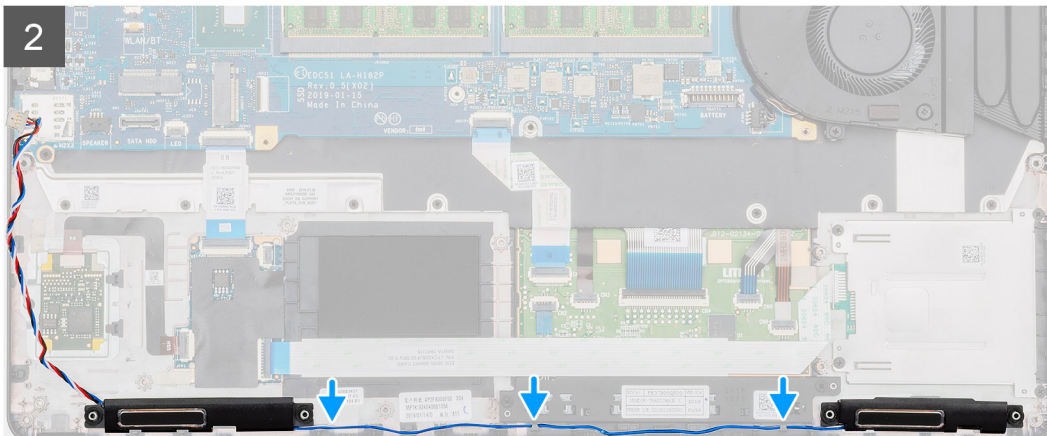
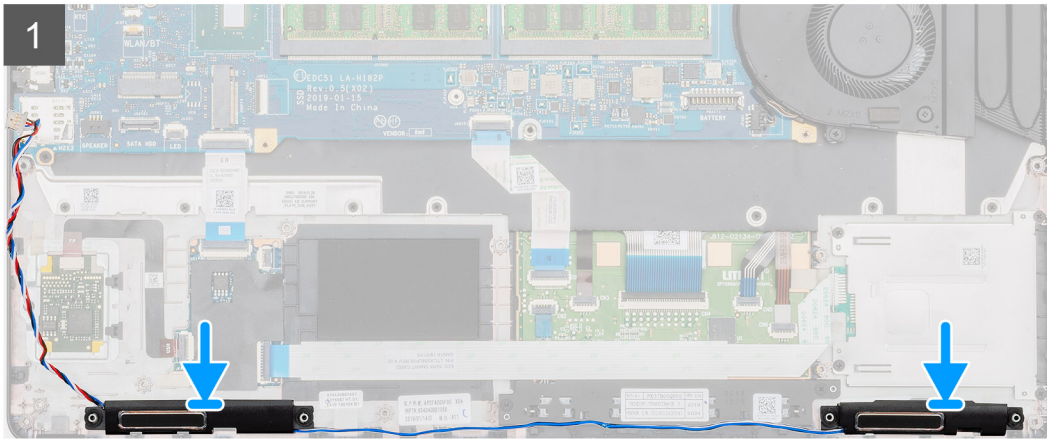
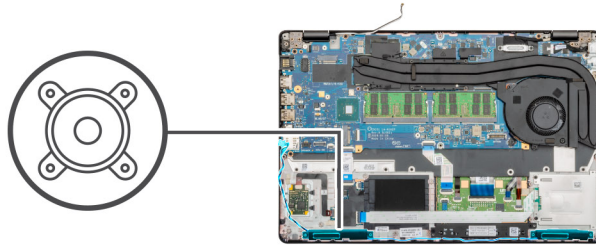

Steps

1. Locate the speakers slot on your computer.
2. Align and place the speakers in the slot on your computer.
3. Route the speaker cables through the retention clips on your computer.

Next steps

1. Install the [LED board](#).
2. Install the [inner frame](#).
3. Install the [WWAN card](#).
4. Install the [WLAN card](#).
5. Install the [HDD](#).
6. Install the [solid state drive](#).
7. Install the [battery](#).
8. Install the [base cover](#).
9. Follow the procedure in [After working inside your computer](#).

Heatsink assembly-Discrete

Removing the heatsink assembly-discrete

Prerequisites

1. Follow the procedure in [Before working inside your computer](#).
2. Remove the [base cover](#).
3. Remove the [battery](#).

About this task

The figure indicates the location of the Heatsink and provides a visual representation of the removal procedure.



2x
M2x5



6x
M2x3

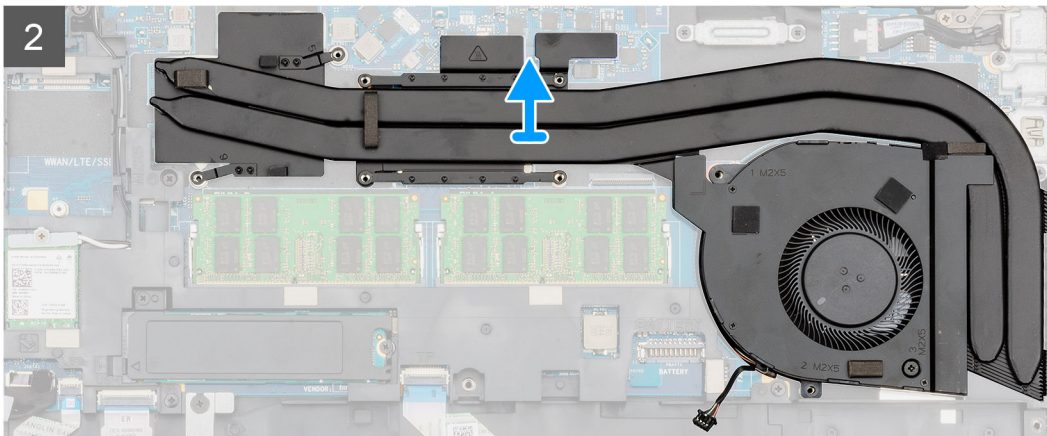
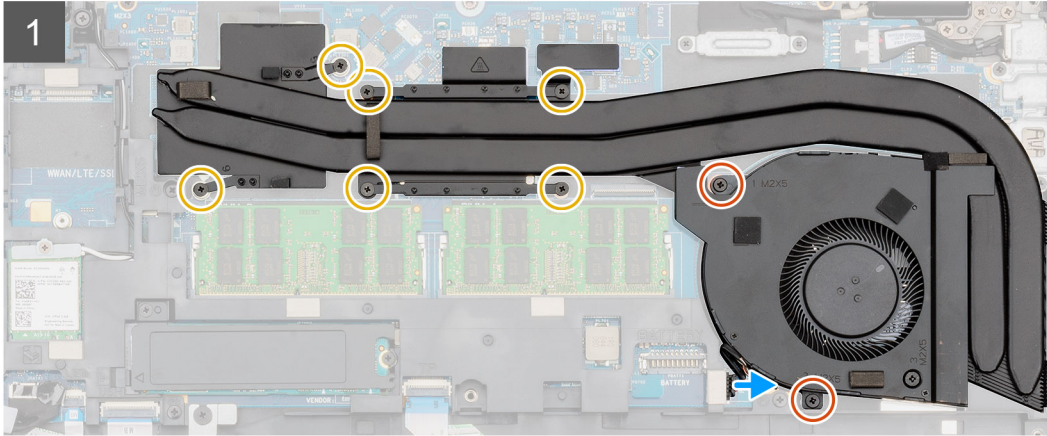
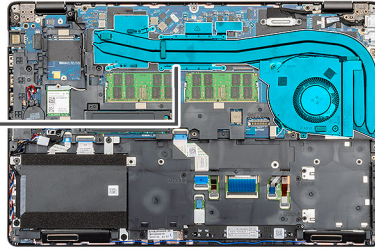

2x
M2x5



6x
M2x3

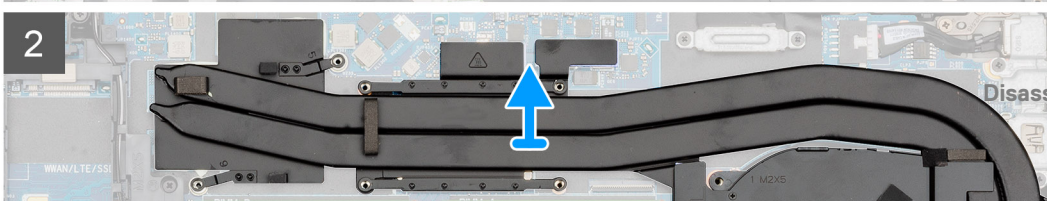
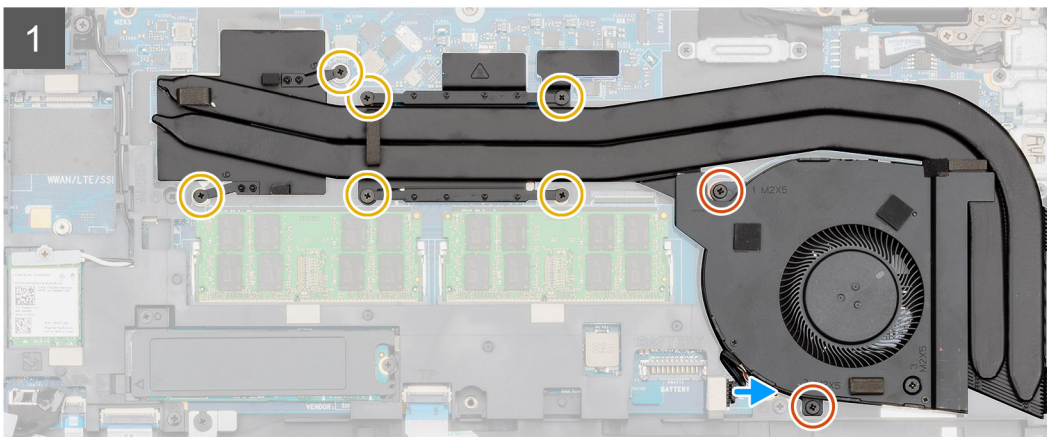
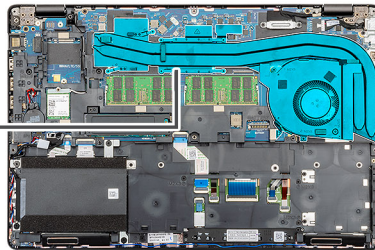



1x
M2x5

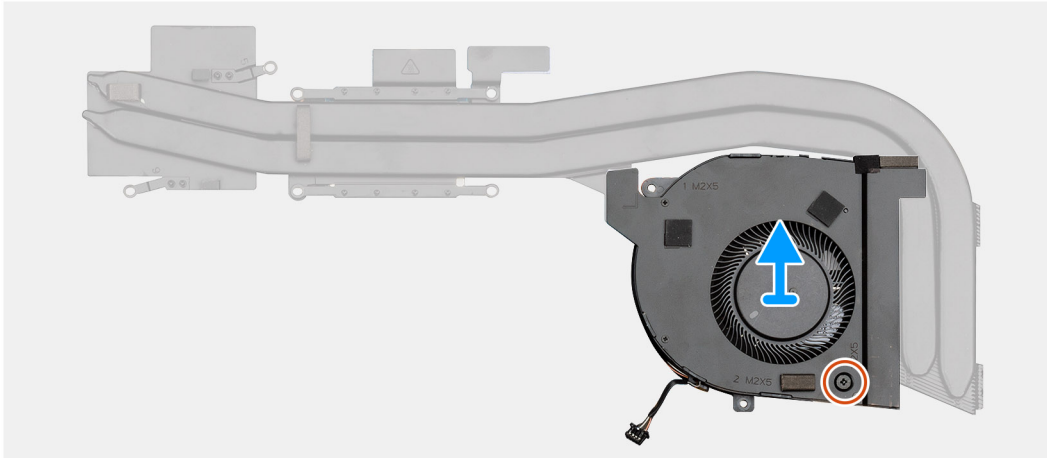
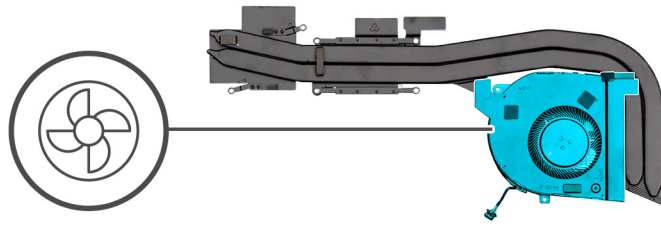

1x
M2x5

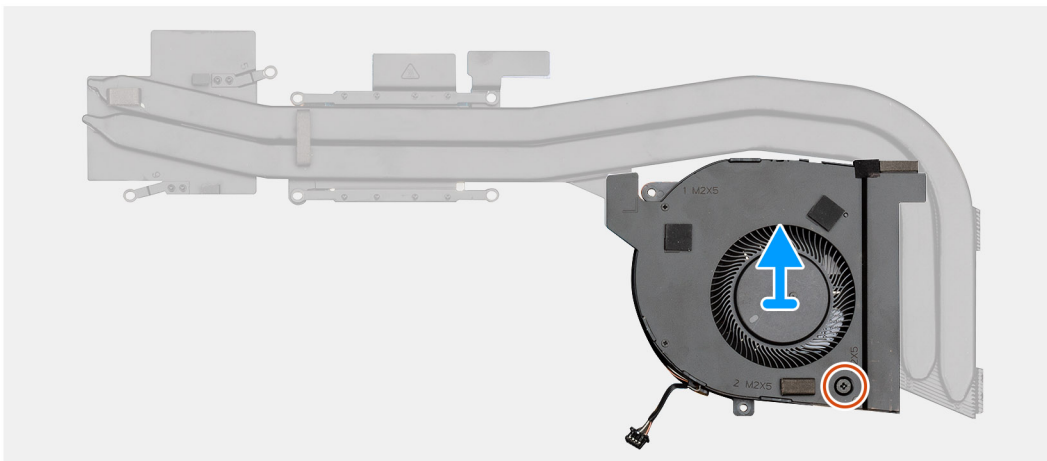
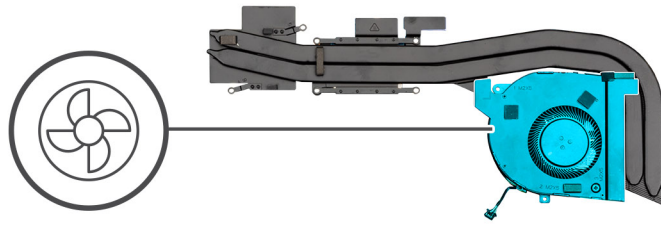

Steps

1. Locate the heatsink assembly on your computer.
2. Remove the two (M2x5) and six (M2x3) captive screws that secures the heatsink assembly to the computer.
3. Disconnect the heatsink fan cable from the system board.
4. Lift the heatsink assembly out of the computer.
5. Remove the single (M2x5) screw that secures the heatsink fan to the heatsink assembly.
6. Lift the heatsink fan from the heatsink assembly.

Installing the heatsink assembly-discrete

Prerequisites

If you are replacing a component, remove the existing component before performing the installation procedure.

About this task

The figure indicates the location of the heatsink and provides a visual representation of the installation procedure.



1x
M2x5

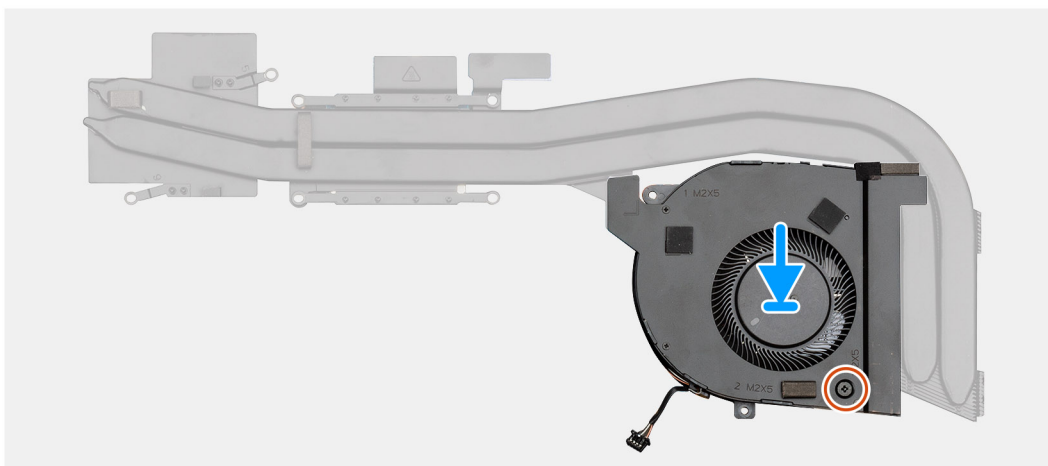
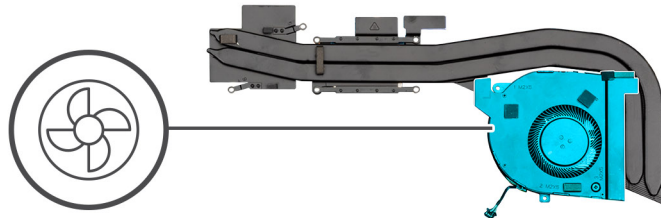



2x
M2x5



6x
M2x3

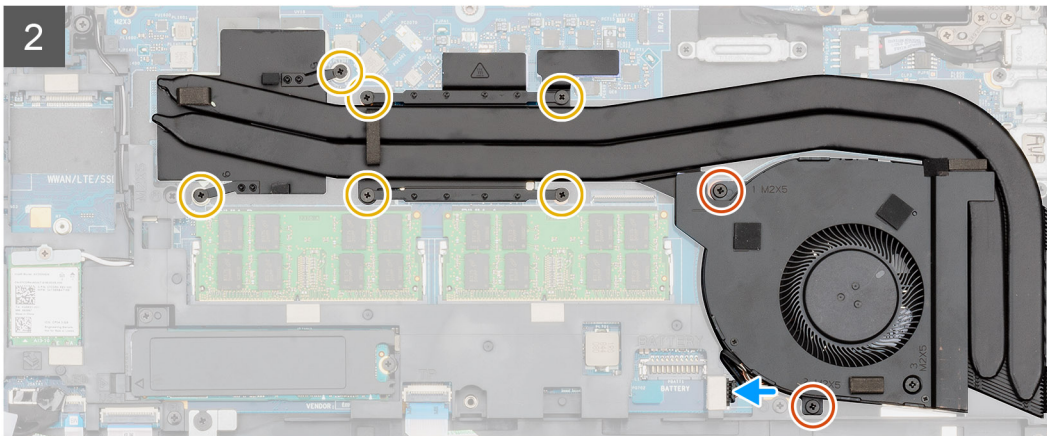
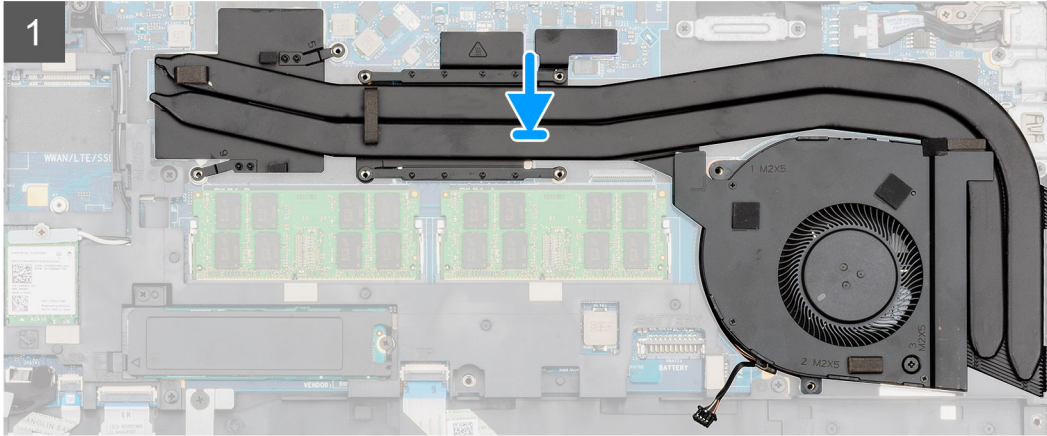
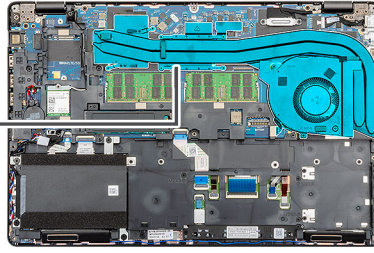

2x
M2x5



6x
M2x3

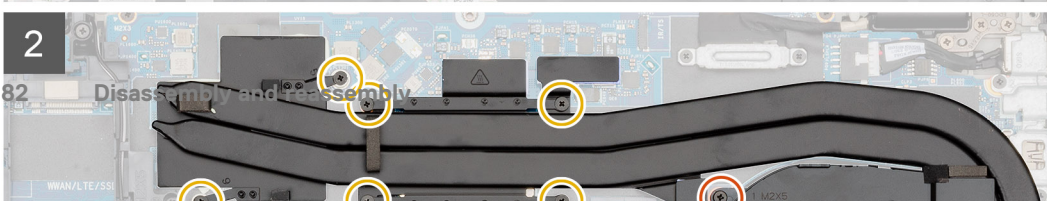
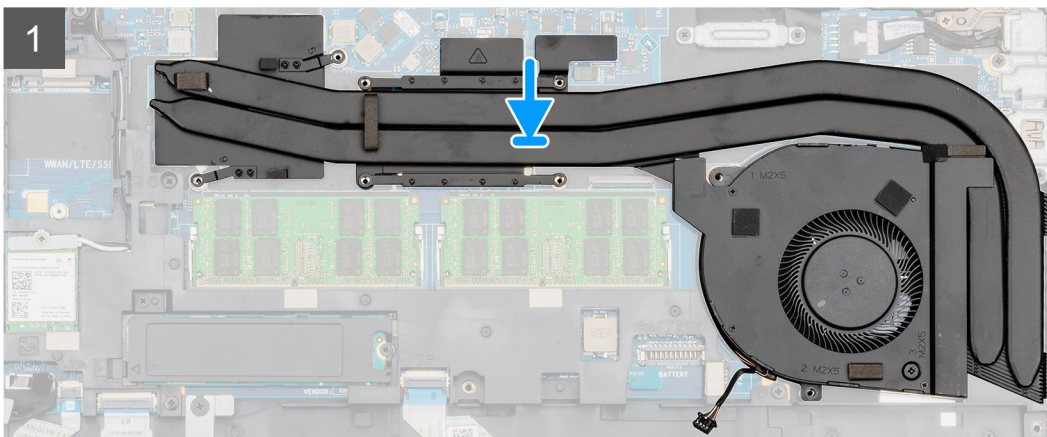
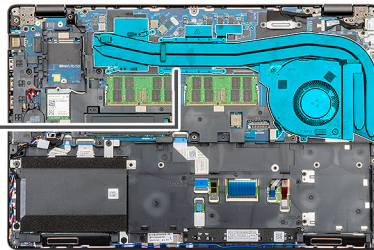

Steps

1. Locate the heatsink slot on your computer.
2. Align and place the heatsink fan on to the heatsink assembly.
3. Install the single (M2x5) screw that secures the heatsink fan to the heatsink assembly.
4. Align and place the heatsink assembly into the slot of your computer.
5. Install the two (M2x5) and six (M2x3) to secure the heatsink assembly to the computer.

 **NOTE: Install the screws as per the callout on the heatsink.**

6. Connect the heatsink fan cable on to the connector on the system board.

Next steps

1. Install the [battery](#).
2. Install the [base cover](#).
3. Follow the procedure in [After working inside your computer](#).

System board

Removing the system board

Prerequisites

1. Follow the procedure in [Before working inside your computer](#).
2. Remove the [base cover](#).
3. Remove the [battery](#).
4. Remove the [solid state drive](#).
5. Remove the [HDD](#).
6. Remove the [WLAN card](#).
7. Remove the [WWAN card](#).
8. Remove the [inner frame](#).
9. Remove the [heat sink](#).
10. Remove the [memory module](#).

About this task

The figure indicates the location of the system board and provides a visual representation of the removal procedure.



3x
M2x3

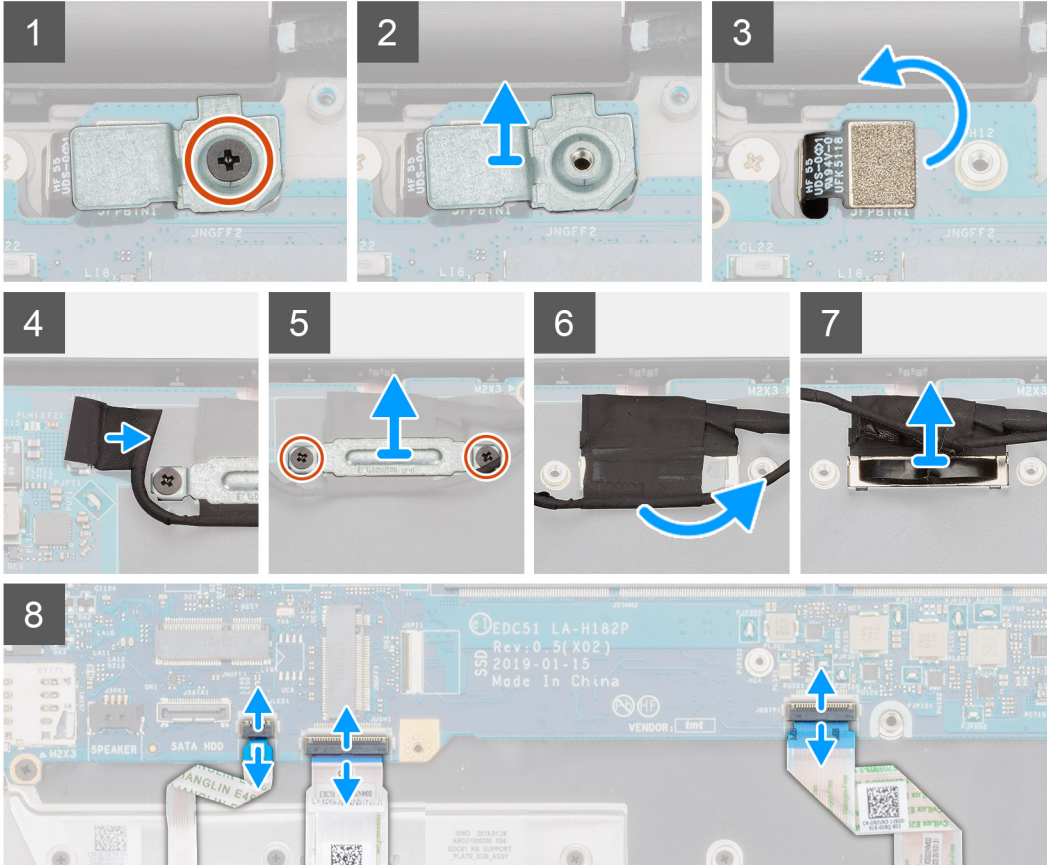
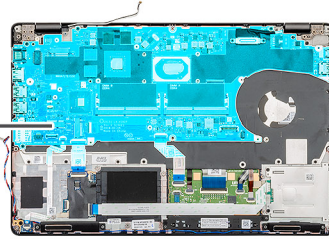

4x
M2x4

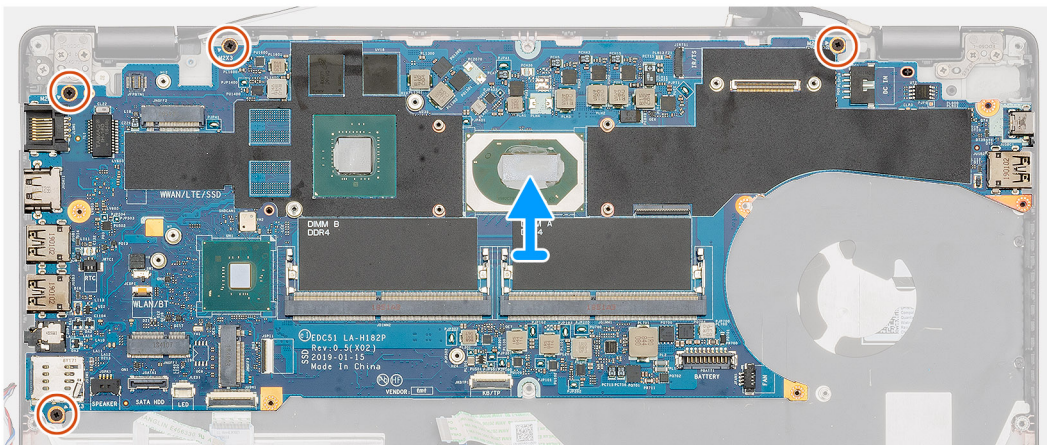
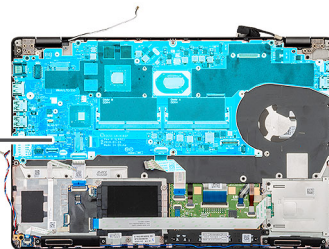



3x
M2x3

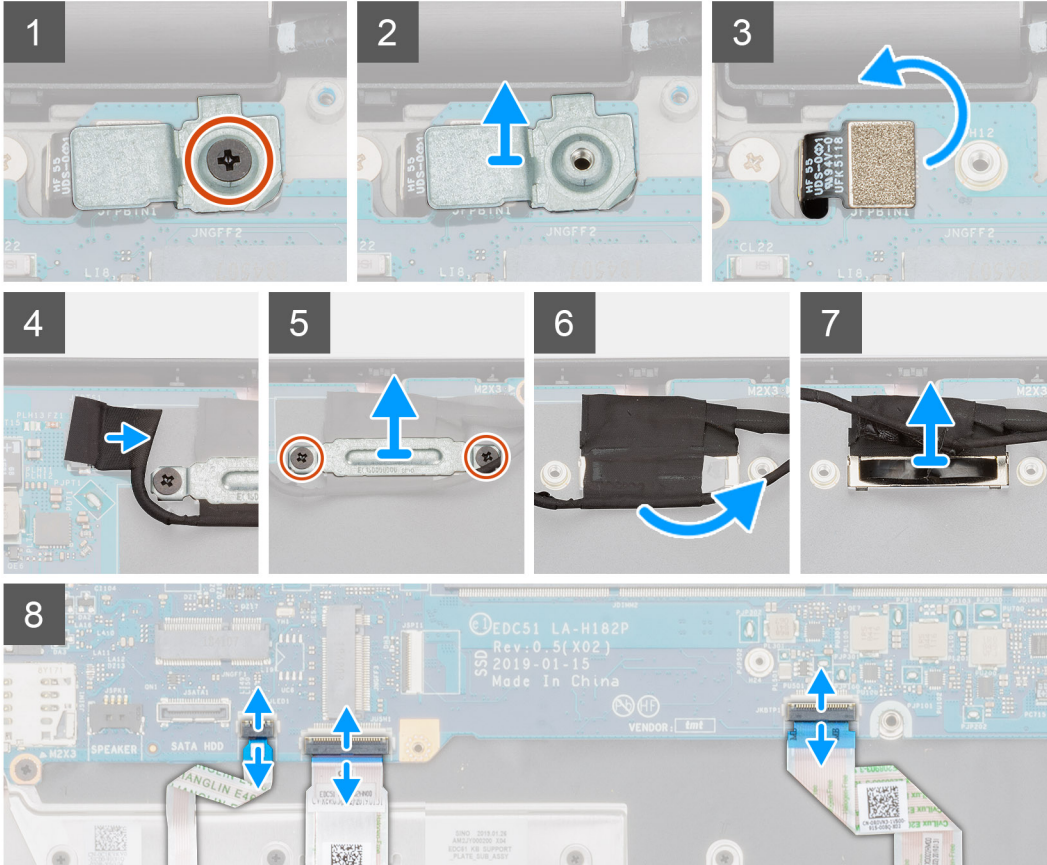
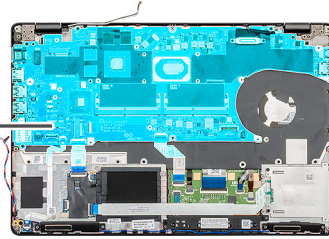

4x
M2x3

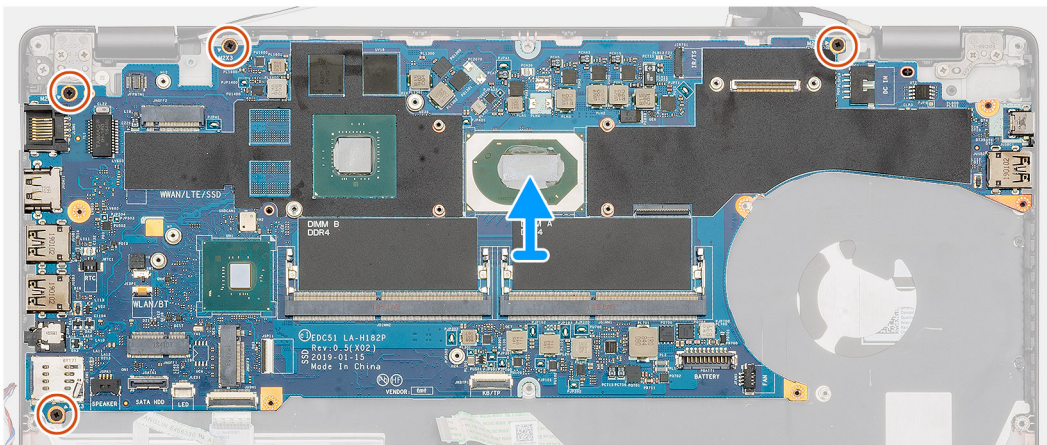
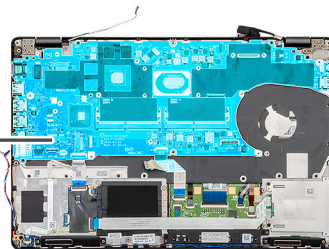

Steps

1. Locate the system board on your computer.
2. Remove the single (M2x3) screw that secures the fingerprint reader metal bracket.
3. Remove the fingerprint metal bracket from the computer and flip the fingerprint sensor over.
4. Disconnect the camera cable from the system board.
5. Remove the two screws that secure the EDP metal bracket.
6. Lift the EDP metal bracket from the computer.
7. Peel the tape that secures the display cable to the system board.
8. Open the latch and disconnect the display cable from the system board.
9. Disconnect the LED board cable, touchpad cable and the keyboard cable from the system board connector.
10. Remove the four (M2x3) screws that secure the system board to the palm-rest and keyboard assembly.
11. Lift the system board off the palm-rest and keyboard assembly.

Installing the system board

Prerequisites

If you are replacing a component, remove the existing component before performing the installation procedure.

About this task

The figure indicates the location of the system board and provides a visual representation of the installation procedure.



4x
M2x4

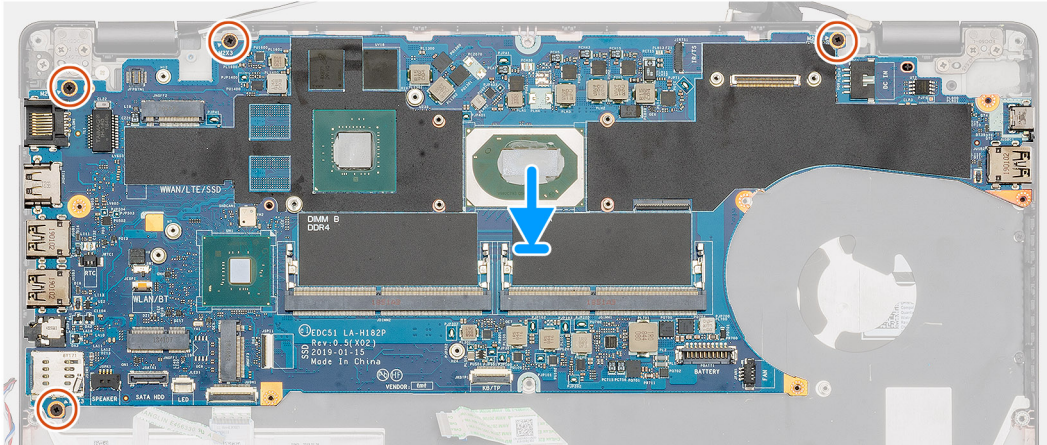
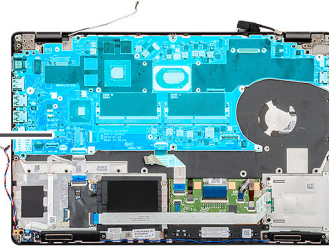

3x
M2x3

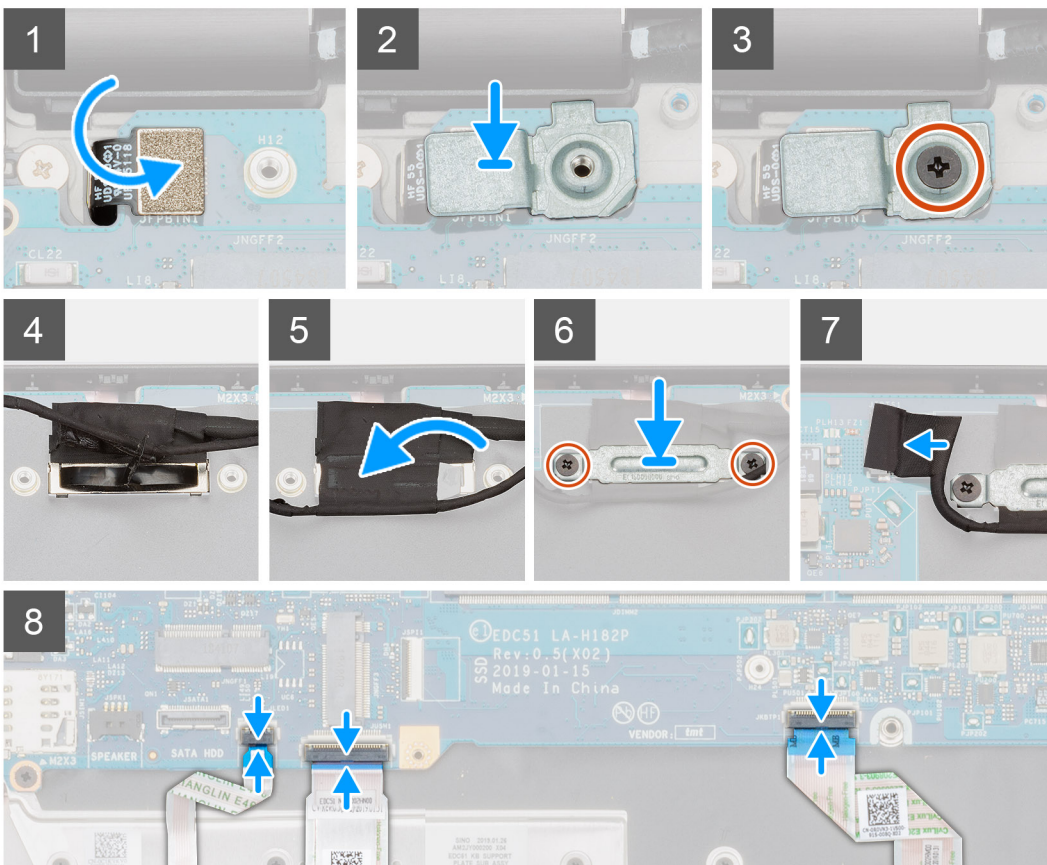
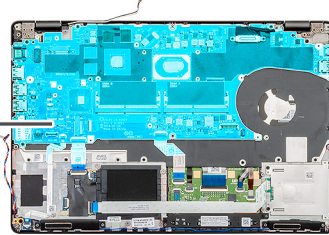



4x
M2x3

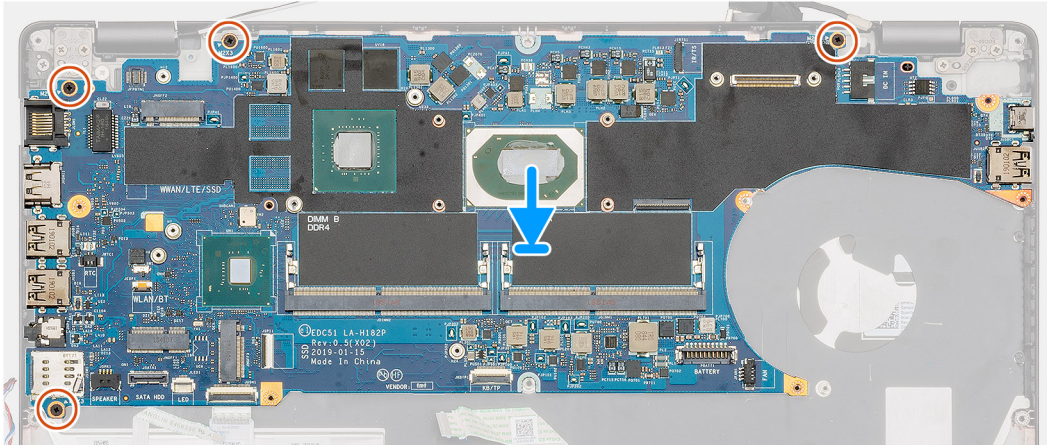
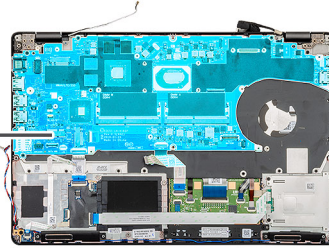

3x
M2x3

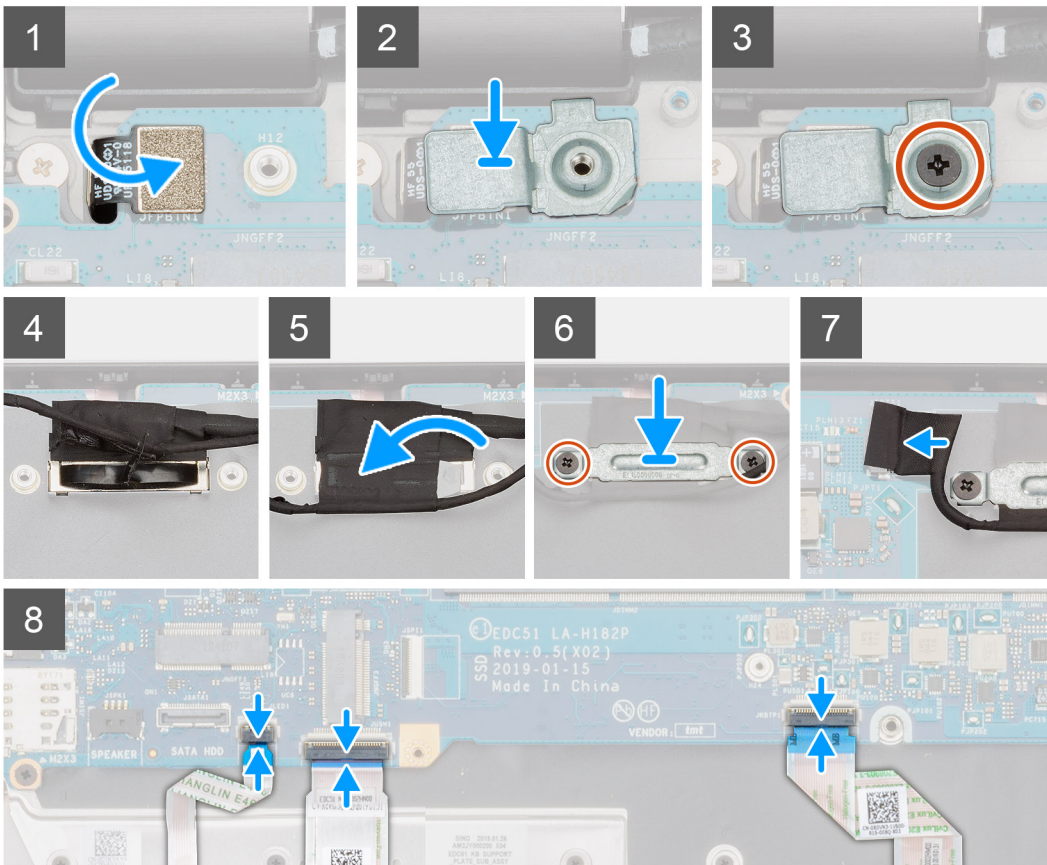
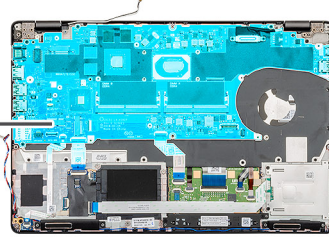

Steps

1. Locate the system board slot on your computer.
2. Slide the ports on the system board into the slots on the palm-rest and keyboard assembly and align the screw holes on the system board with the screw holes on the palm-rest and keyboard assembly.
3. Install the four (M2x3) screws that secure the system board to the palm-rest and keyboard assembly.
4. Align and place the fingerprint reader sensor on to the slot on the computer.
5. Place the finger print reader metal bracket over the finger print sensor.
6. Replace the single (M2x3) screw to secure the metal bracket to the computer.
7. Connect the display cable on to the connector on the system board.
8. Adhere the tape that secures the display board to the system board.
9. Install the two screws (M2x3) that secure the EDP metal bracket to the system board.
10. Connect the keyboard cable to the system board and close the latch to secure the cable.
11. Connect the touchpad cable to the system board and close the latch to secure the cable.
12. Connect the LED board cable to the system board.

Next steps

1. Install the [memory module](#).
2. Install the [heat sink](#).
3. Install the [inner frame](#).
4. Install the [WWAN card](#).
5. Install the [WLAN card](#).
6. Install the [HDD](#).
7. Install the [solid state drive](#).
8. Install the [battery](#).
9. Install the [base cover](#).
10. Follow the procedure in [After working inside your computer](#).

Keyboard

Removing the Keyboard

Prerequisites

1. Follow the procedure in [Before working inside your computer](#).
2. Remove the [base cover](#).
3. Remove the [battery](#).
4. Remove the [solid state drive](#).
5. Remove the [HDD](#).
6. Remove the [WLAN card](#).
7. Remove the [WWAN card](#).
8. Remove the [inner frame](#).
9. Remove the [memory module](#).
10. Remove the [system board](#).

 **NOTE: System board can be removed with heatsink attached.**

About this task

The figure indicates the location of the keyboard and provides a visual representation of the removal procedure.



22x
M2x2

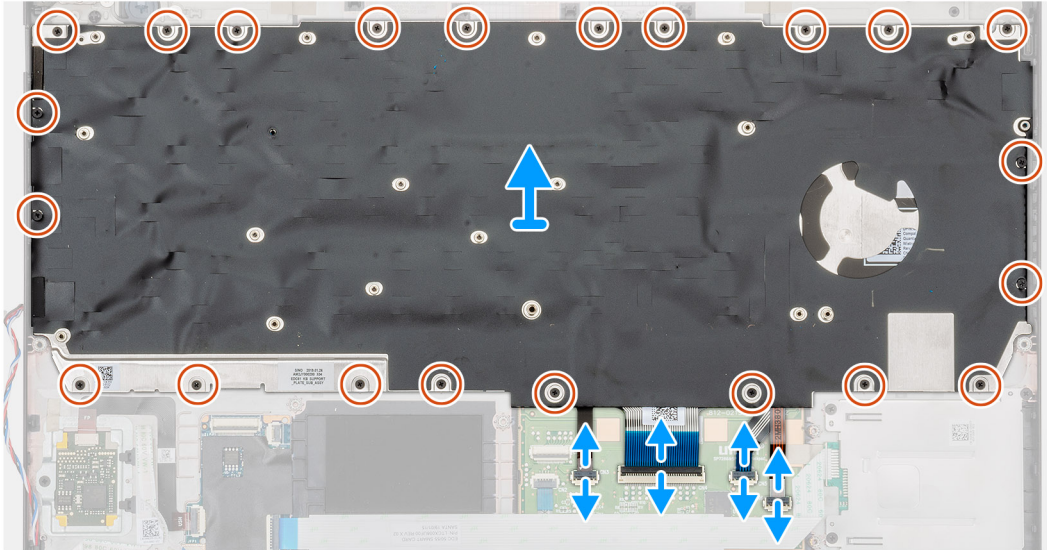
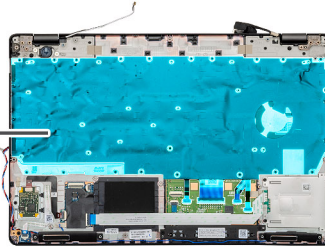

22x
M2x2

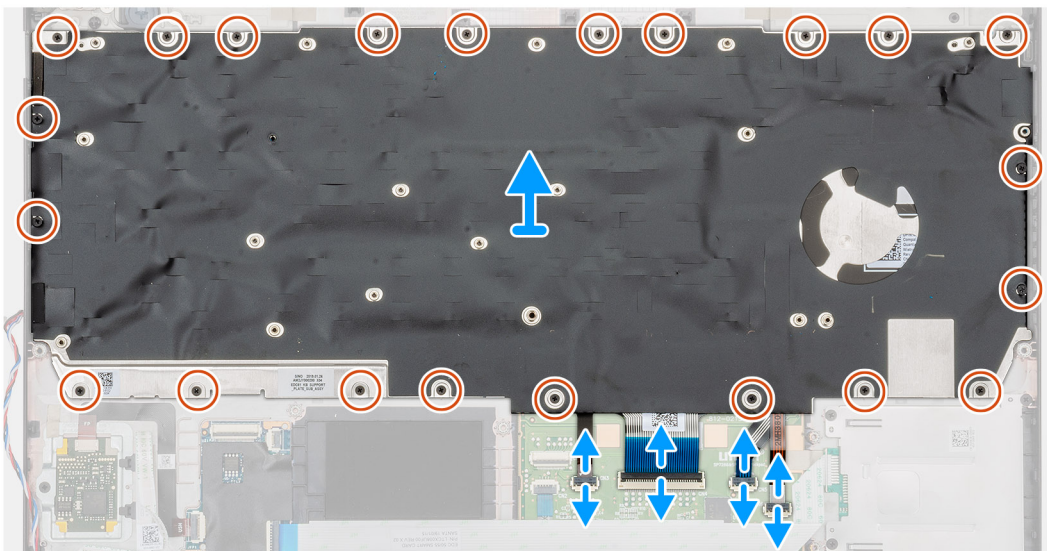
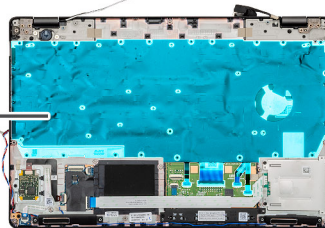

Steps

1. Locate the Keyboard on your computer.
2. Open the latch and disconnect the Keyboard, keyboard backlit cables from the palmrest.
3. Remove the 22 (M2x2) screws that secure the keyboard to the chassis of your computer.

4. Lift the keyboard out of the computer.

Installing the Keyboard

Prerequisites

If you are replacing a component, remove the existing component before performing the installation procedure.

About this task

The figure indicates the location of the keyboard and provides a visual representation of the installation procedure.



22x
M2x2

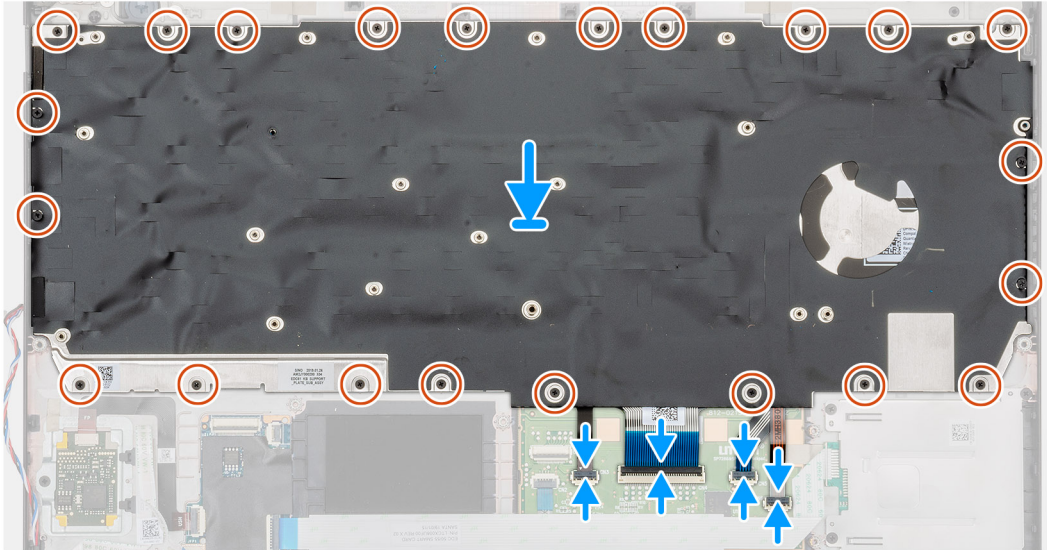
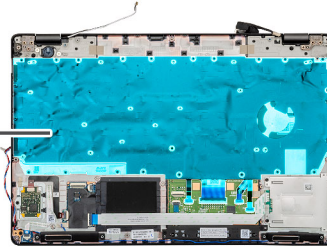

22x
M2x2

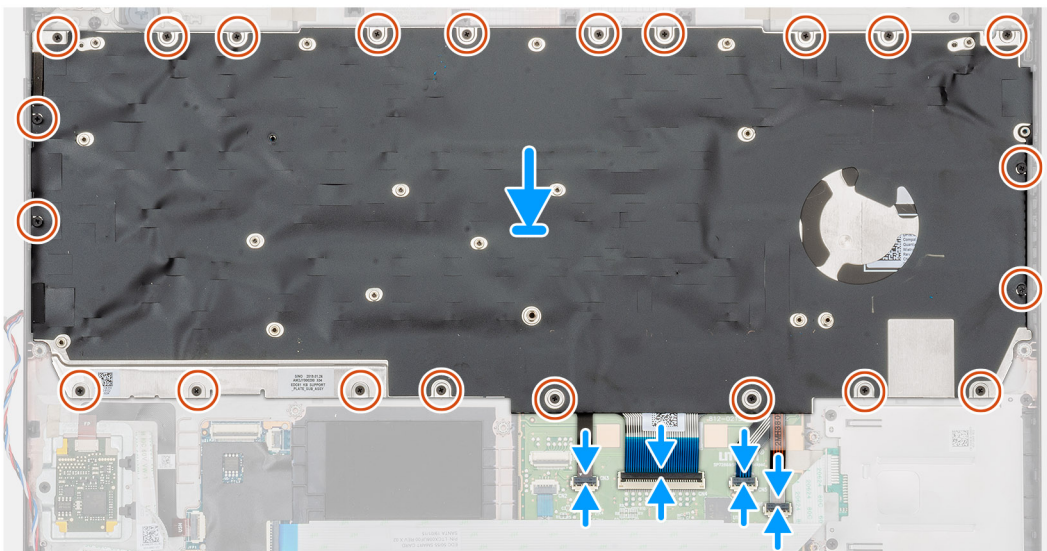
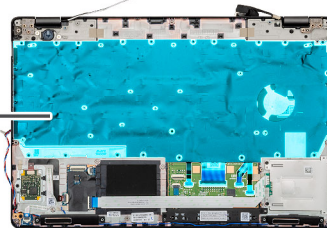

Steps

1. Locate the Keyboard slot on your computer.
2. Align and place the keyboard into the slot on your computer.
3. Install the 22 (M2x2) screws that secure the keyboard to the chassis of the computer.

4. Connect the keyboard, keyboard backlit cables on to the connector on the palmrest.

Next steps

1. Install the [system board](#).
i **NOTE: System board can be removed with heatsink attached.**
2. Install the [memory module](#)
3. Install the [inner frame](#).
4. Install the [WWAN card](#).
5. Install the [WLAN card](#).
6. Install the [HDD](#).
7. Install the [solid state drive](#).
8. Install the [battery](#).
9. Install the [base cover](#).
10. Follow the procedure in [After working inside your computer](#).

Keyboard bracket

Removing the keyboard bracket

Prerequisites

1. Follow the procedure in [Before working inside your computer](#).
2. Remove the [base cover](#).
3. Remove the [battery](#).
4. Remove the [solid-state drive](#).
5. Remove the [HDD](#).
6. Remove the [WLAN card](#).
7. Remove the [WWAN card](#).
8. Remove the [inner frame](#).
9. Remove the [memory module](#).
10. Remove the [system board](#).
i **NOTE: System board can be removed with heatsink attached.**
11. Remove the [keyboard](#).

About this task

The figure indicates the location of the keyboard bracket and provides a visual representation of the removal procedure.



11x
M2x2



11x
M2x2



Steps

1. Locate the keyboard bracket on your computer.
2. Remove the eleven (M2x2) screws that secure the keyboard bracket to the keyboard assembly.
3. Lift the keyboard away from the keyboard bracket.

Installing the keyboard bracket

Prerequisites

If you are replacing a component, remove the existing component before performing the installation procedure.

About this task

The figure indicates the location of the keyboard bracket and provides a visual representation of the installation procedure.



11x
M2x2

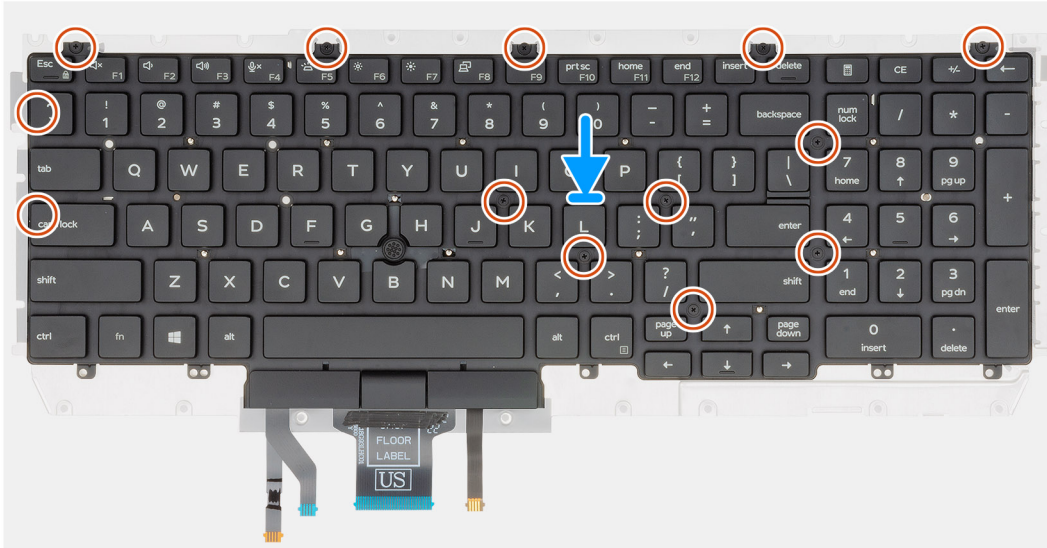

11x
M2x2



Steps

1. Locate the keyboard bracket slot on your computer.
2. Align and place the keyboard on the keyboard bracket.
3. Press down on the lattice at the snap points, in order to secure the keyboard assembly to the palmrest.

NOTE: The keyboard has multiple snap points on the lattice side which must be pushed down firmly after the keyboard is replaced.

4. Install the eleven (M2x2) screws to secure the keyboard to the keyboard bracket.

Next steps

1. Install the [keyboard](#).
2. Install the [system board](#).

NOTE: System board can be removed with heatsink attached.

3. Install the [memory module](#).
4. Install the [inner frame](#).
5. Install the [WWAN card](#).
6. Install the [WLAN card](#).
7. Install the [HDD](#).
8. Install the [solid state drive](#).
9. Install the [battery](#).
10. Install the [base cover](#).
11. Follow the procedure in [After working inside your computer](#).

Power button

Removing the power button with fingerprint reader

Prerequisites

1. Follow the procedure in [Before working inside your computer](#).
2. Remove the [base cover](#).
3. Remove the [battery](#).
4. Remove the [solid state drive](#).
5. Remove the [HDD](#).
6. Remove the [WLAN card](#).
7. Remove the [WWAN card](#).
8. Remove the [inner frame](#).
9. Remove the [memory module](#).
10. Remove the [system board](#).

NOTE: The system board can be removed along with the heat sink.

About this task

The figure indicates the location of the power button with fingerprint reader and provides a visual representation of the removal procedure.



2x
M2x2

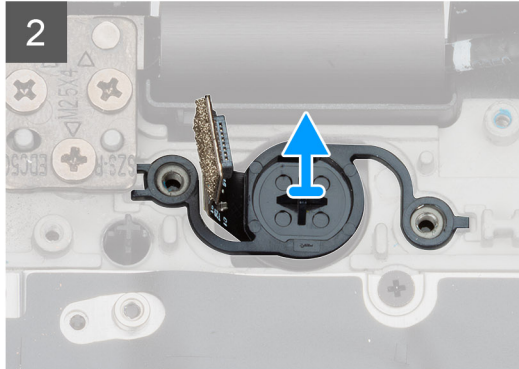
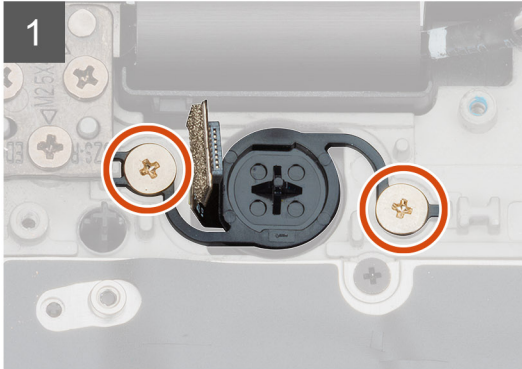
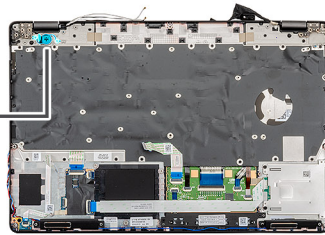

2x
M2x2

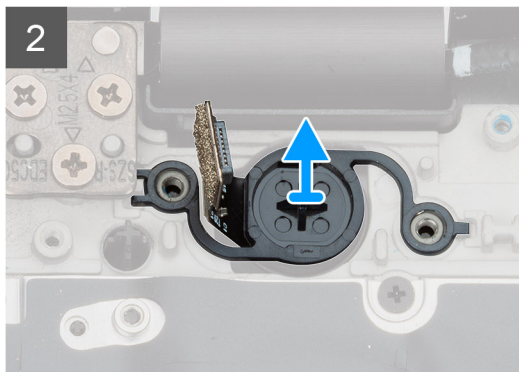
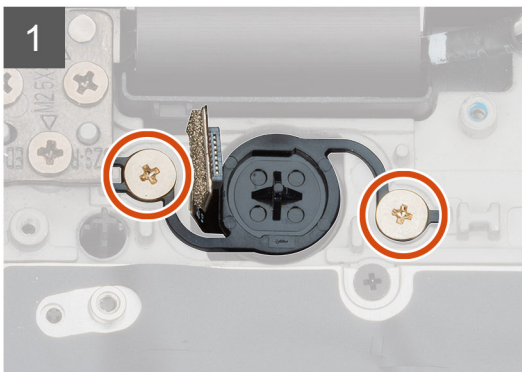
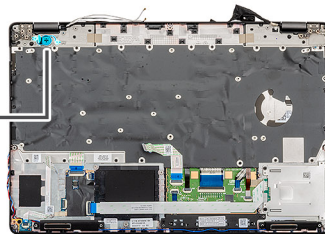

Steps

1. Locate the power button with fingerprint reader on your computer.
2. Remove the two (M2x2) screws that secure the power button to chassis of your computer.
3. Lift the power button with fingerprint out of the computer.

Installing the power button with fingerprint

Prerequisites

If you are replacing a component, remove the existing component before performing the installation procedure.

About this task

The figure indicates the location of the power button with fingerprint and provides a visual representation of the installation procedure.



2x
M2x2

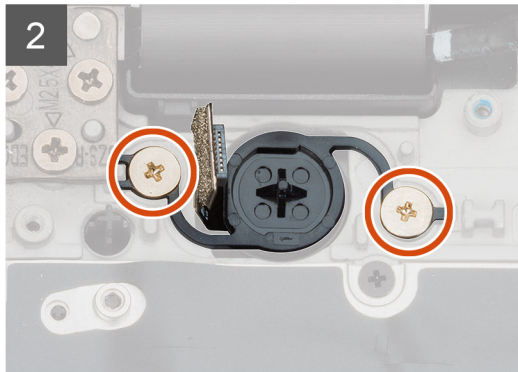
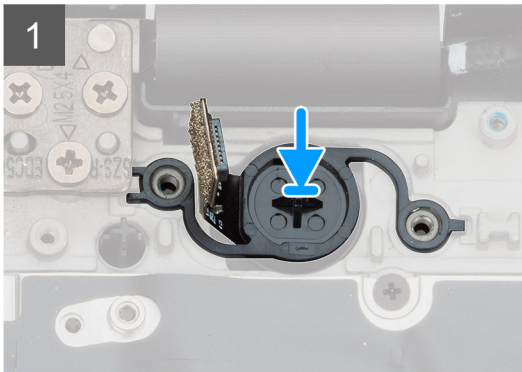
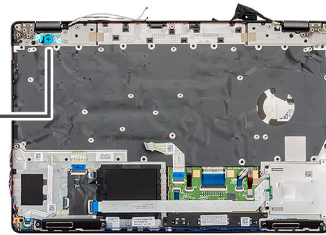

2x
M2x2

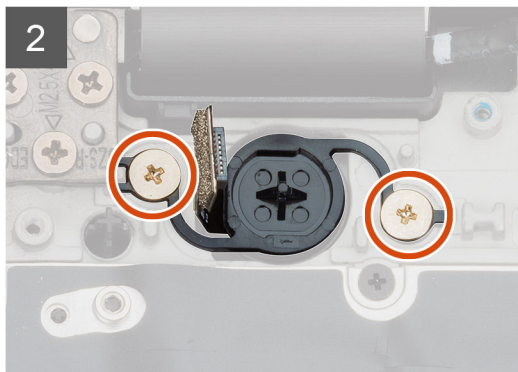
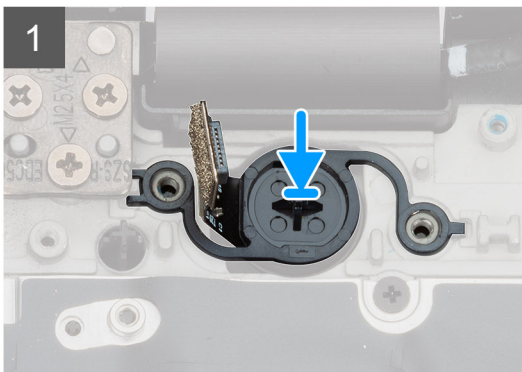
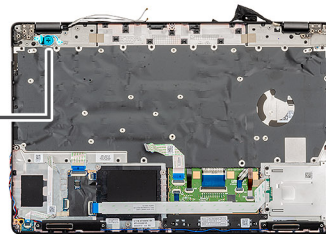

Steps

1. Locate the power button with fingerprint slot on your computer.
2. Align and place the power button with fingerprint into the slot on your computer.
3. Install the two (M2x2) screws that secure the power button to chassis of your computer.

Next steps

1. Install the [system board](#).
2. Install the [memory module](#).
3. Install the [inner frame](#).
4. Install the [WWAN card](#).
5. Install the [WLAN card](#).
6. Install the [HDD](#).
7. Install the [solid state drive](#).
8. Install the [battery](#).
9. Install the [base cover](#).

10. Follow the procedure in [After working inside your computer](#).

Display assembly

Removing the display assembly

Prerequisites

1. Follow the procedure in [Before working inside your computer](#).
2. Remove the [base cover](#).
3. Remove the [battery](#).
4. Remove the [WLAN card](#).
5. Remove the [WWAN card](#).

About this task

The figure indicates the location of the display assembly and provides a visual representation of the removal procedure.



2x
M2x3



6x
M2.5x4

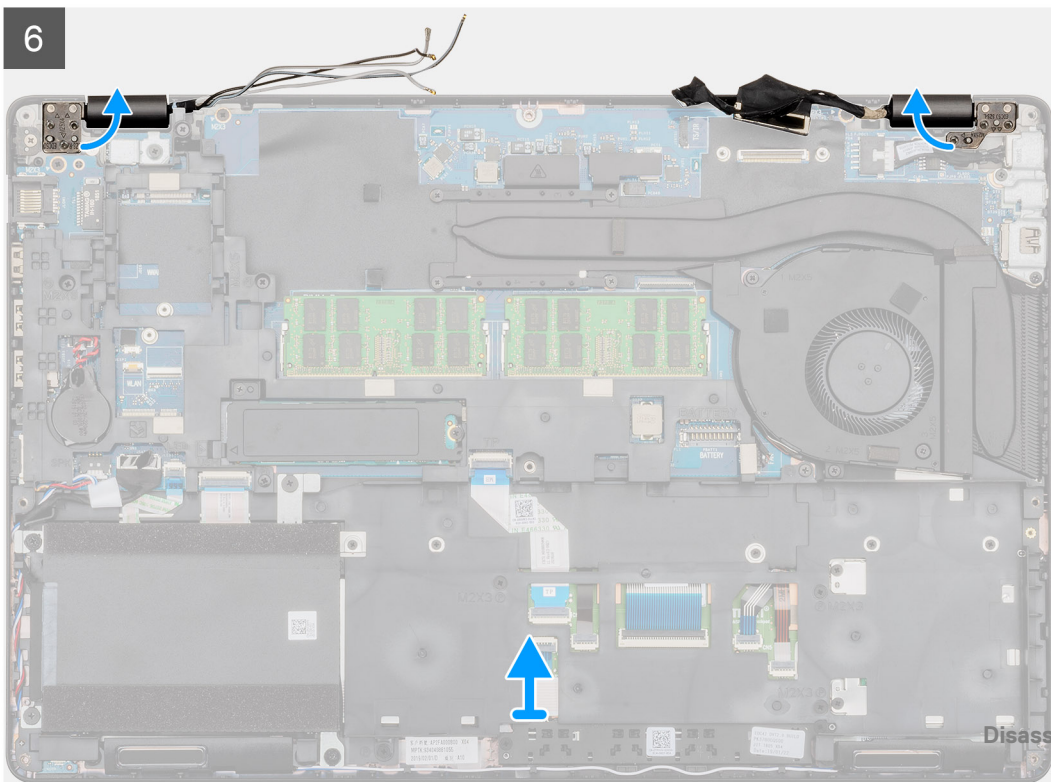
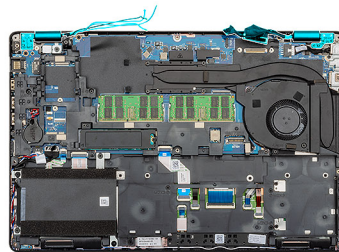
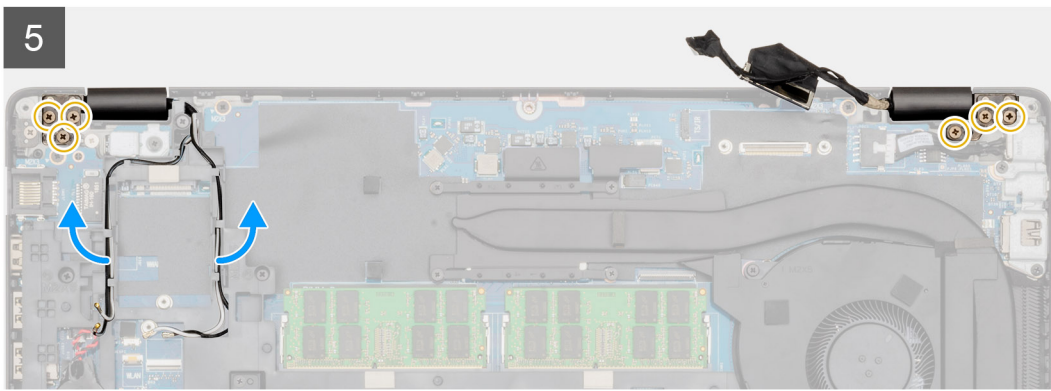
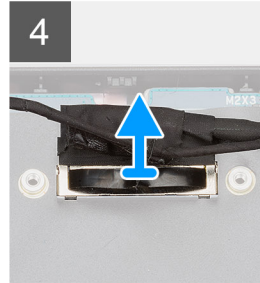
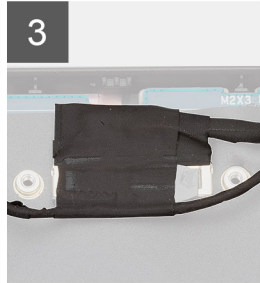
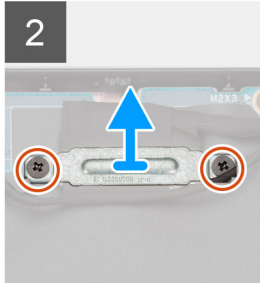
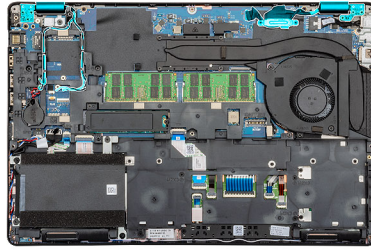

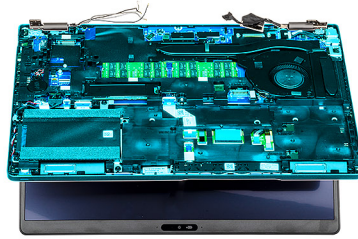

7

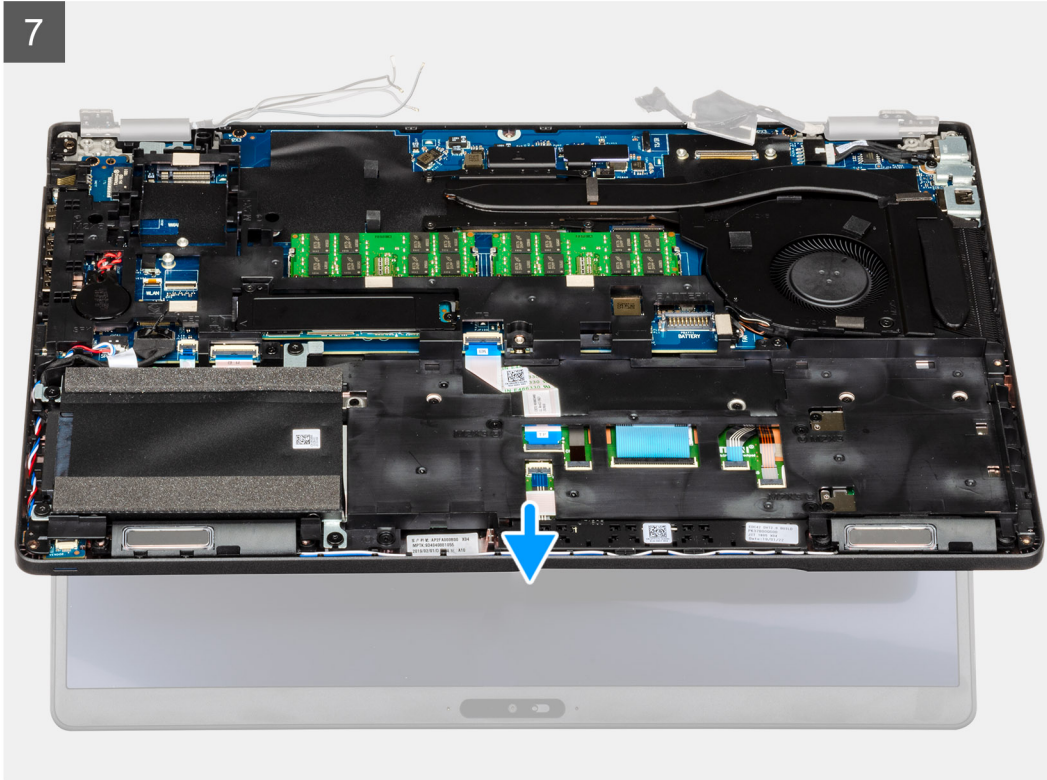

8





2x
M2x3



6x
M2.5x4

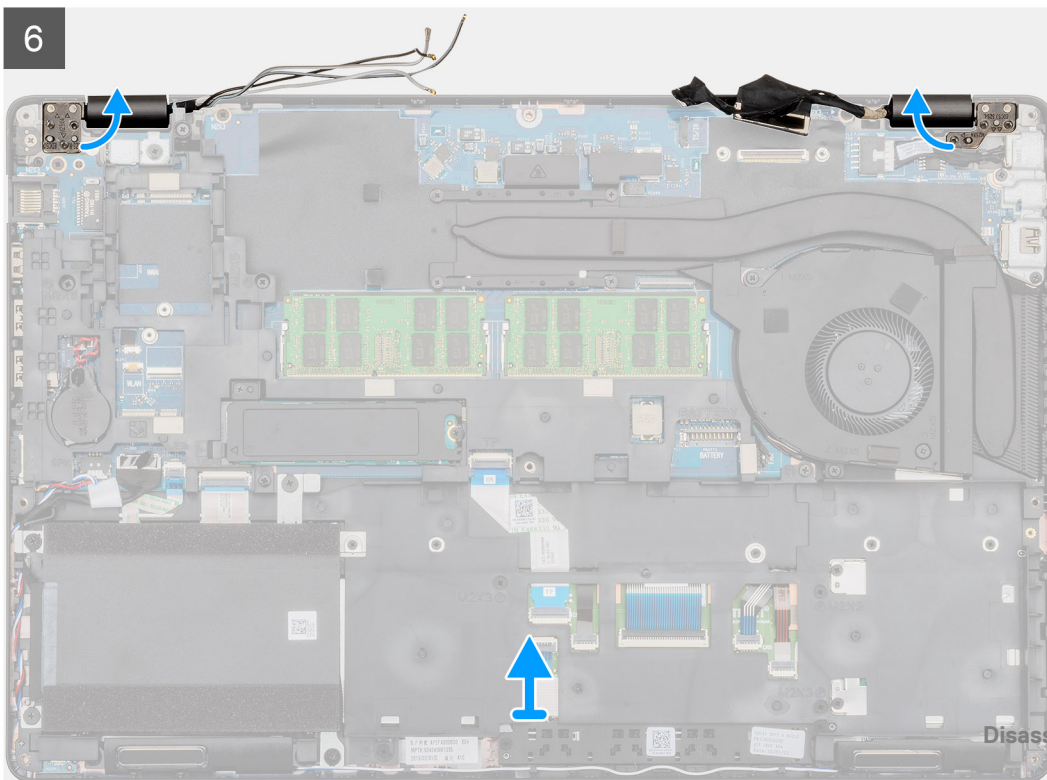
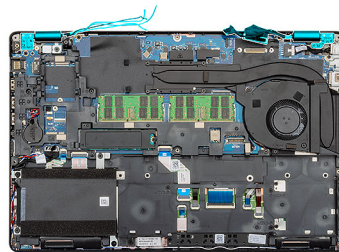
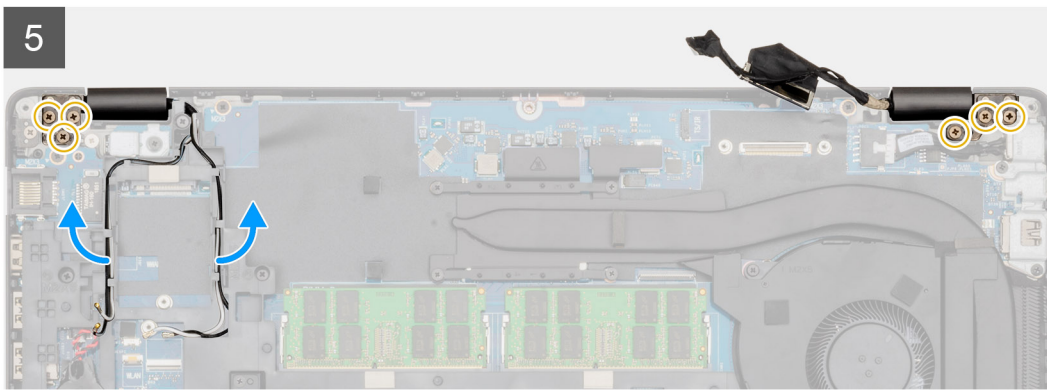
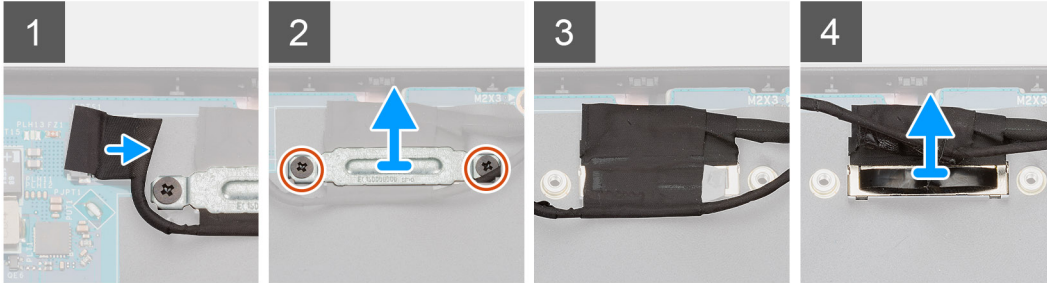
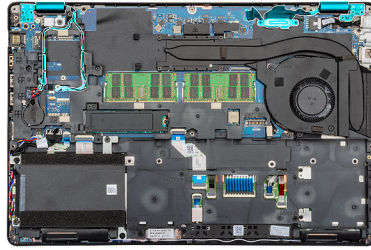

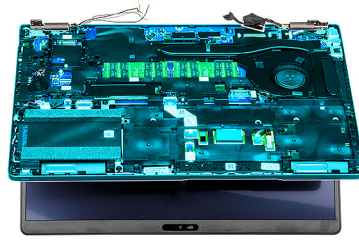

7

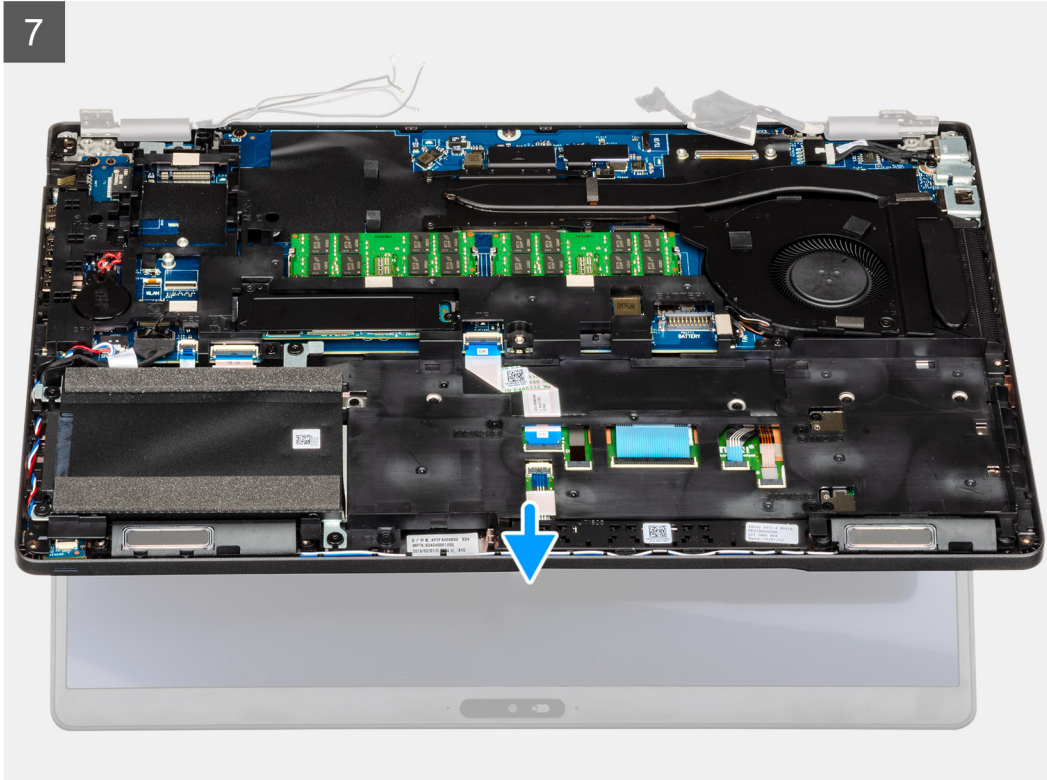

8



Steps

1. Locate the display cable, touchscreen cable and display hinges on your computer.
2. Peel back the tape and disconnect the touchscreen cable.
3. Remove the two (M2x3) screws that secure the EDP metal bracket to the computer.
4. Peel the tape that secures the display cable to the system board.
5. Open the latch and disconnect the display cable from the system board.
6. Unroute the WLAN and WWAN cables from the retention clips.
7. Remove the six (M2.5x4) screws that secure the display hinges to the chassis of your computer.
8. Open the display hinges at an angle of 90 degrees and slightly open the display.
9. Remove the palm-rest and keyboard assembly off the display assembly.

Installing the display assembly

Prerequisites

If you are replacing a component, remove the existing component before performing the installation procedure.

About this task

The figure indicates the location of the component and provides a visual representation of the installation procedure.

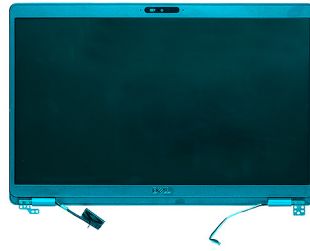

1

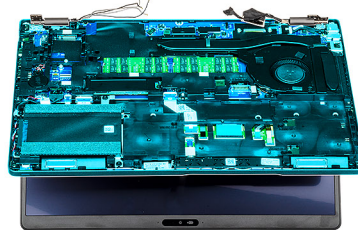

2

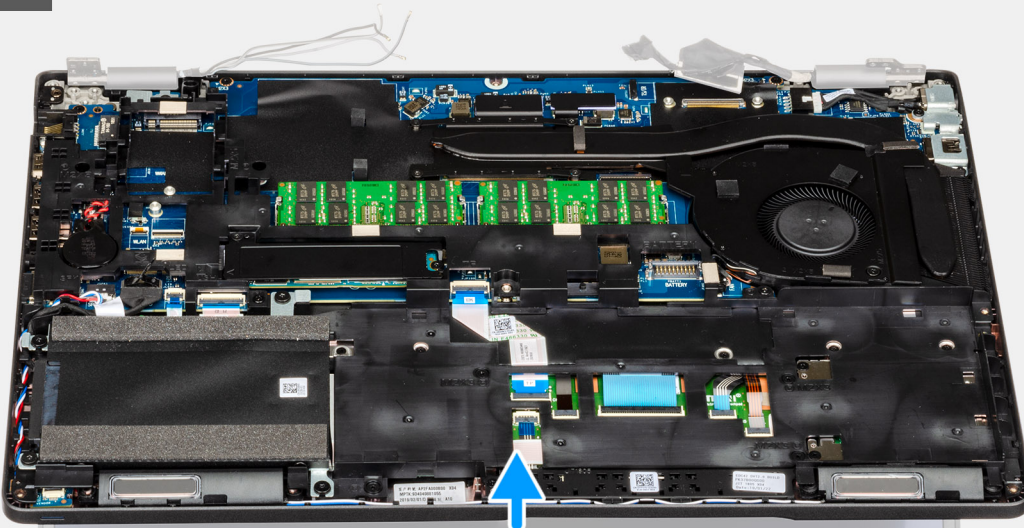

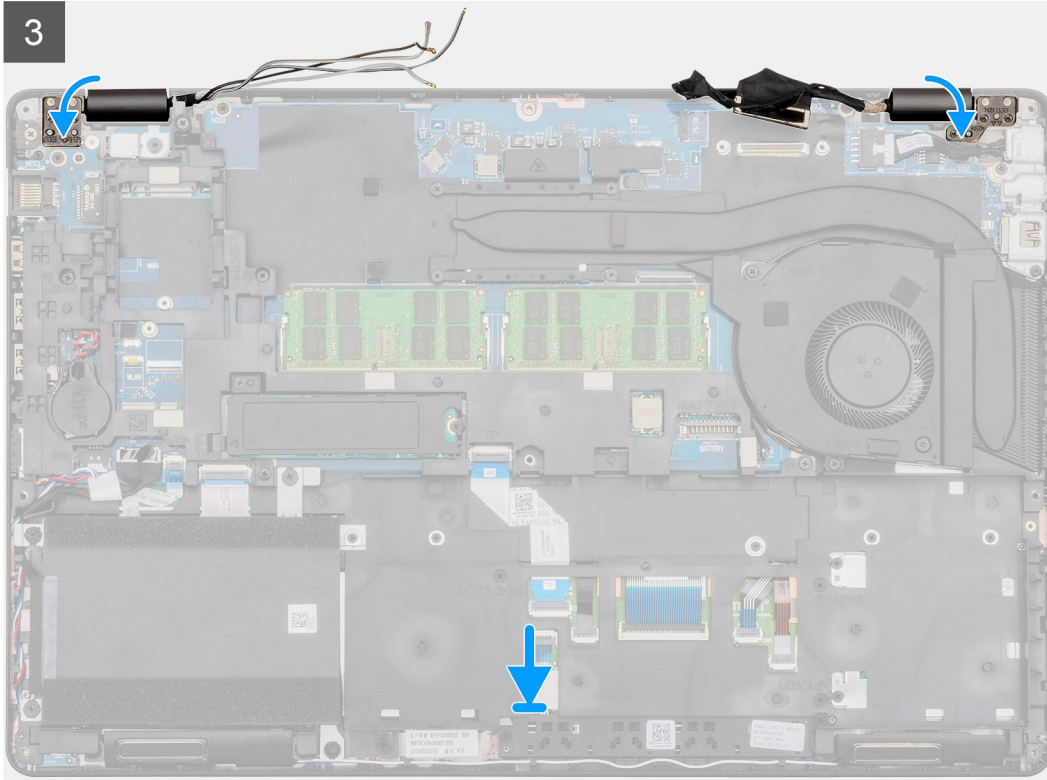
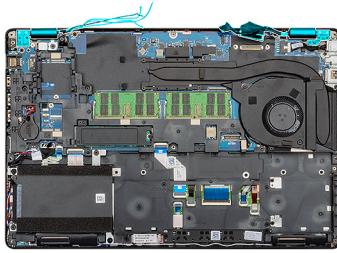

2x
M2x3



6x
M2.5x4

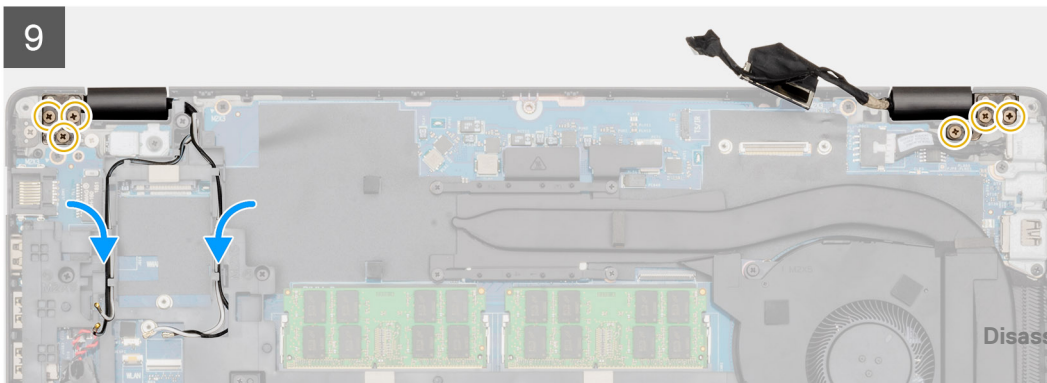
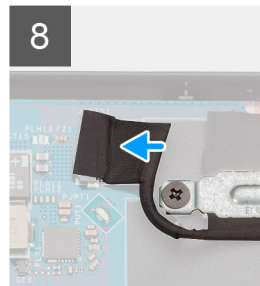
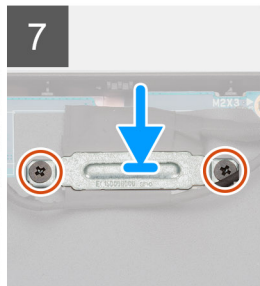
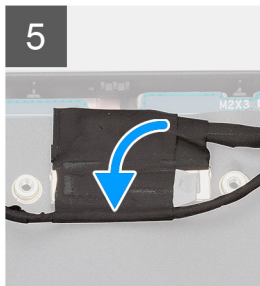
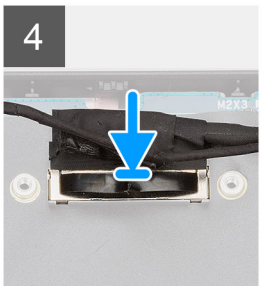
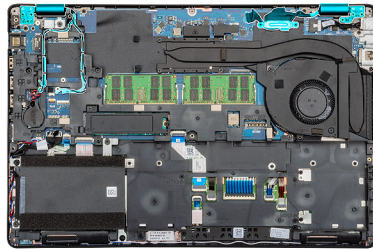

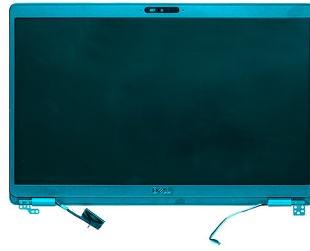

1

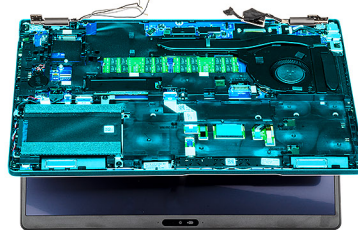

2

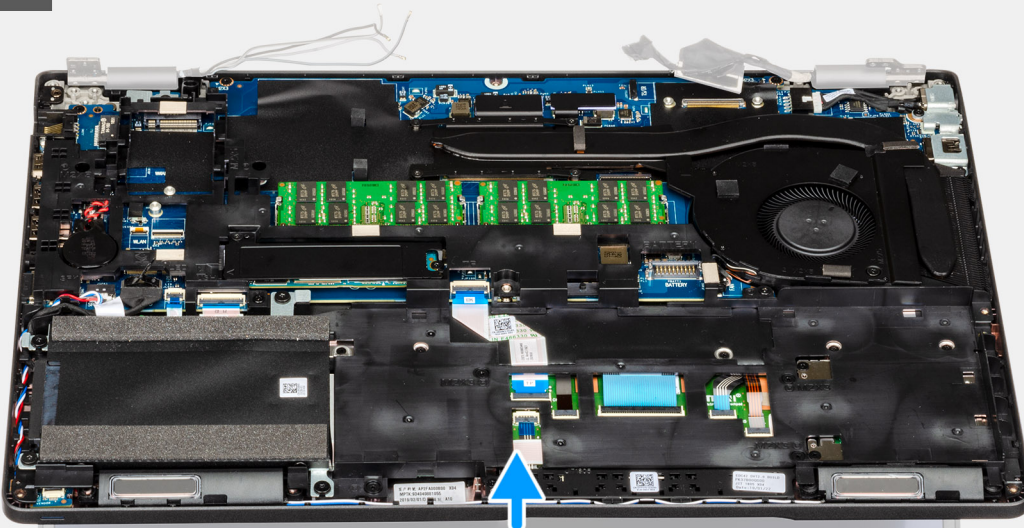

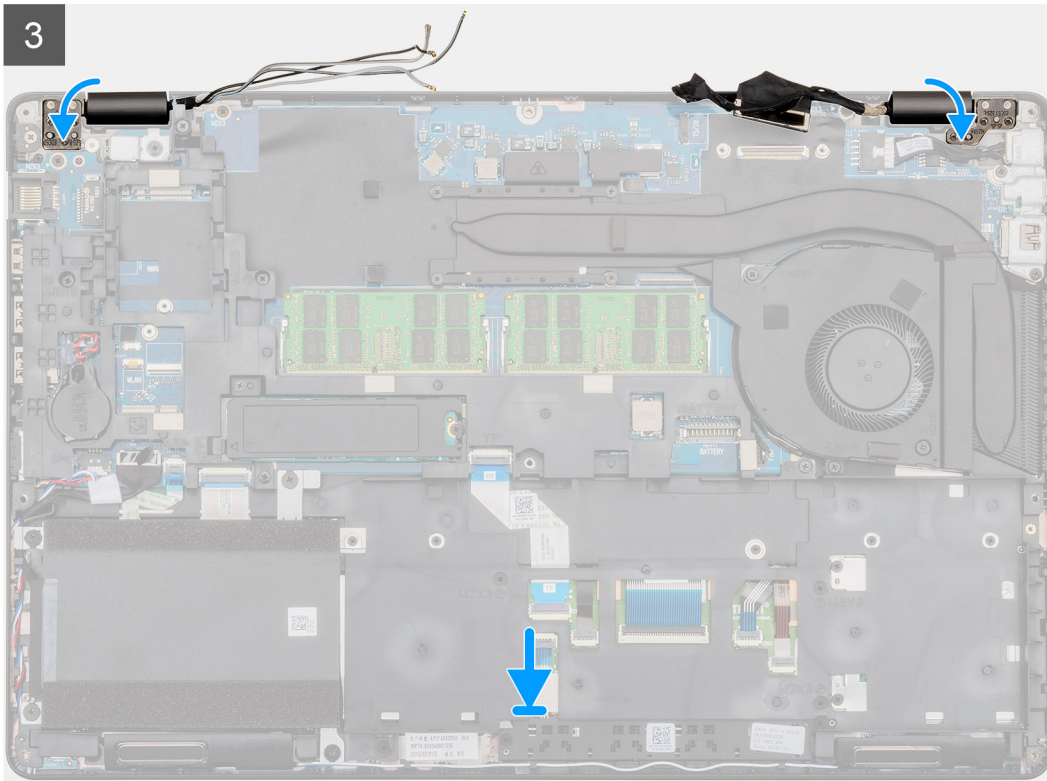
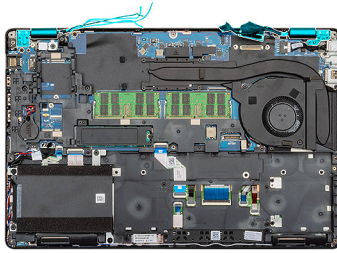

2x
M2x3



6x
M2.5x4

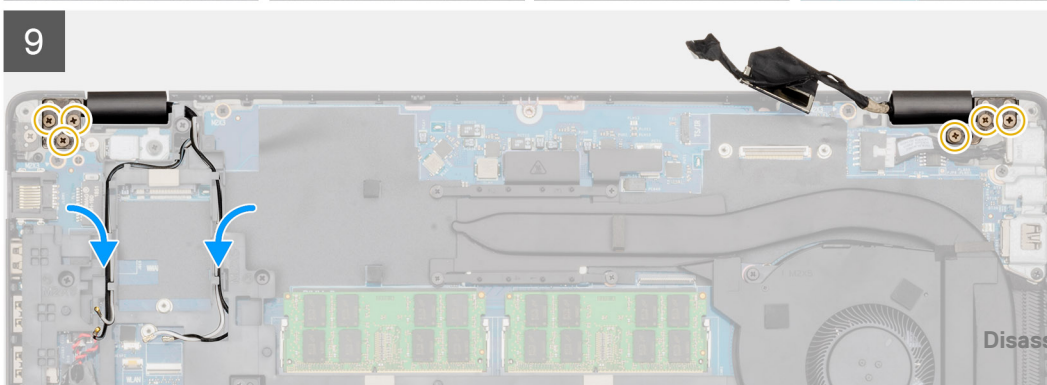
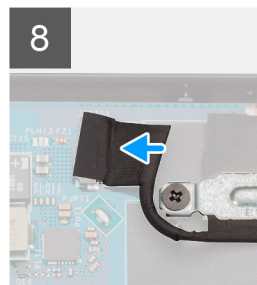
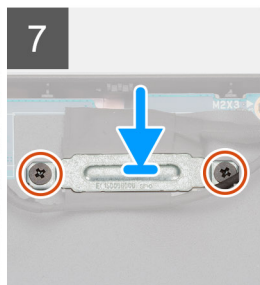
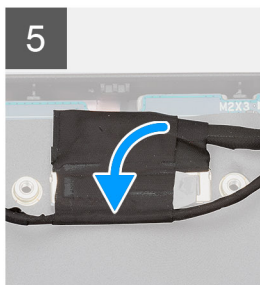
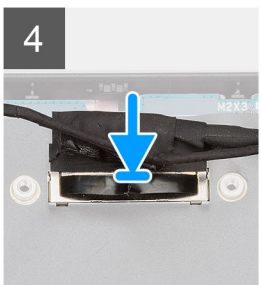
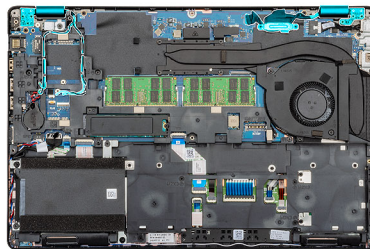

Steps

1. Place the display assembly on a clean and flat surface.
2. Align and place the palm-rest and keyboard assembly on the display assembly.
3. Using the alignment posts, close the display hinges.
4. Connect the display cable to the system board and adhere the tape to secure the display cable.
5. Place the EDP metal bracket on the display cable connector.
6. Replace the two (M2x3) screw to secure the EDP metal bracket to the system board.
7. Connect the touchscreen cable to the connector on the system board.
8. Replace the six (M2.5x4) screws that secure the display hinge to the chassis of the computer.
9. Route the WWAN cable and the WLAN cable through the retention clips provided.

Next steps

1. Install the [WWAN card](#).
2. Install the [WLAN card](#).
3. Install the [battery](#).
4. Install the [base cover](#).
5. Follow the procedure in [After working inside your computer](#).

Display bezel

Removing the display bezel

Prerequisites

1. Follow the procedure in [Before working inside your computer](#).
2. Remove the [base cover](#).
3. Remove the [battery](#).
4. Remove the [WLAN card](#).
5. Remove the [WWAN card](#).
6. Remove the [display assembly](#).

About this task

The figure indicates the location of the display bezel and provides a visual representation of the removal procedure.

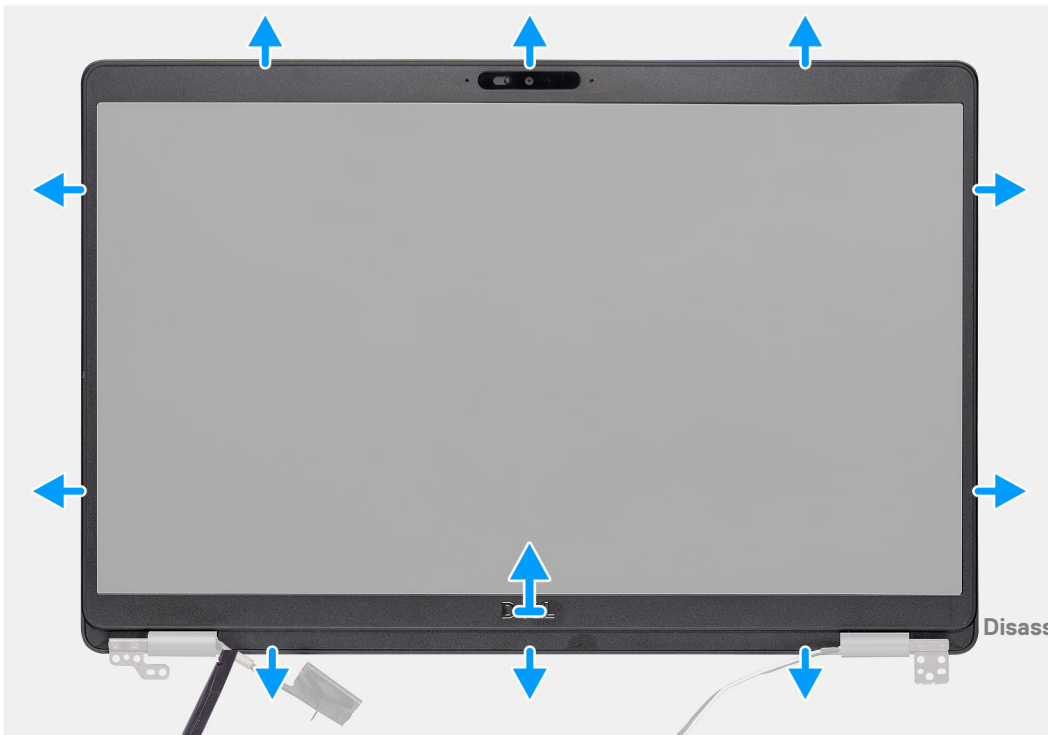
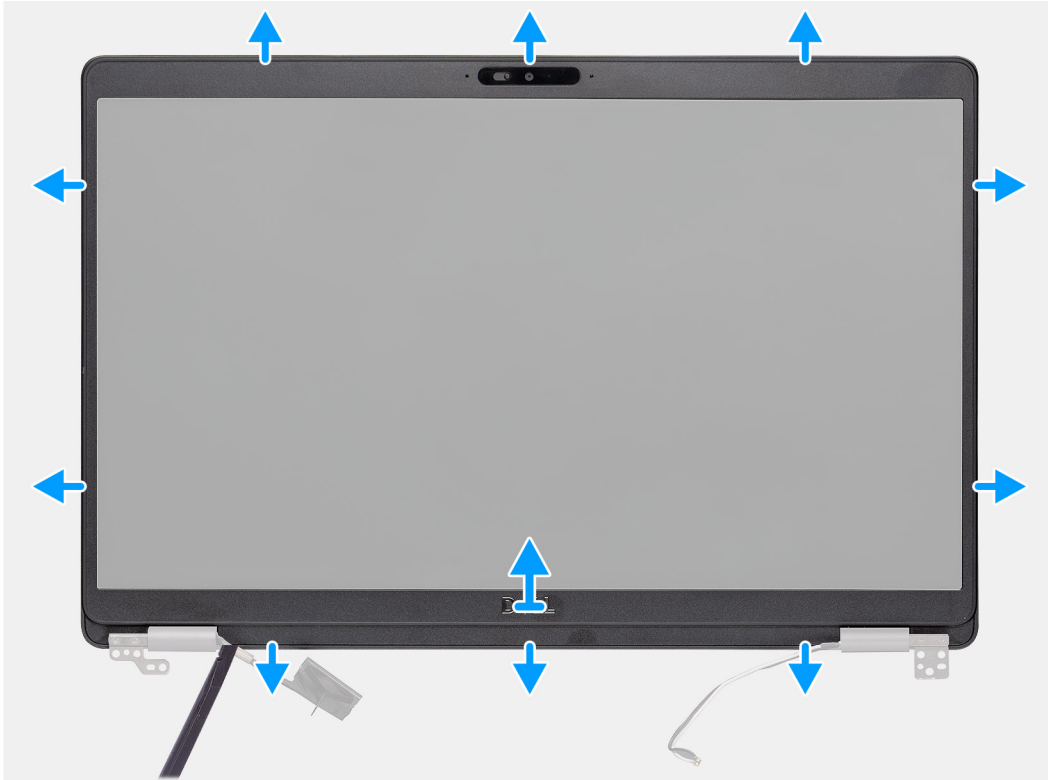

Steps

1. Use a plastic scribe to pry open the bottom edge of the display bezel beginning from the recesses near the hinges.
2. Work your way around the edges of the display bezel to release it from the display back cover and antenna assembly.
3. Remove the display bezel off the display back-cover and antenna assembly.

Installing the display bezel

Prerequisites

If you are replacing a component, remove the existing component before performing the installation procedure.

About this task

The figure indicates the location of the display bezel and provides a visual representation of the installation procedure.

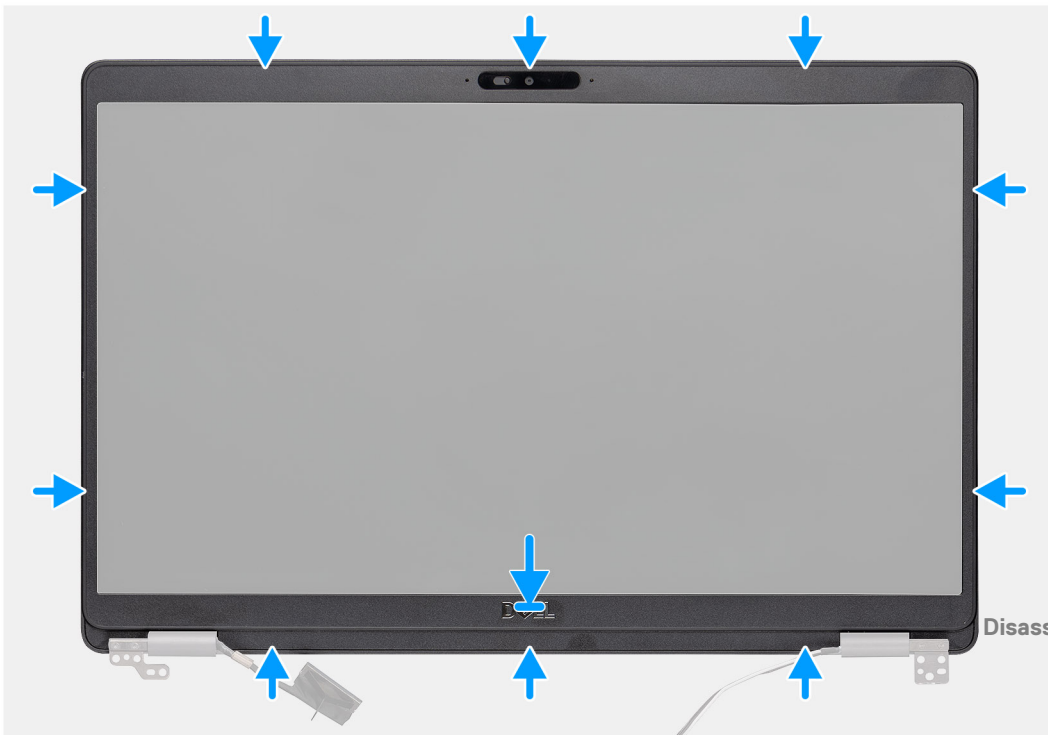
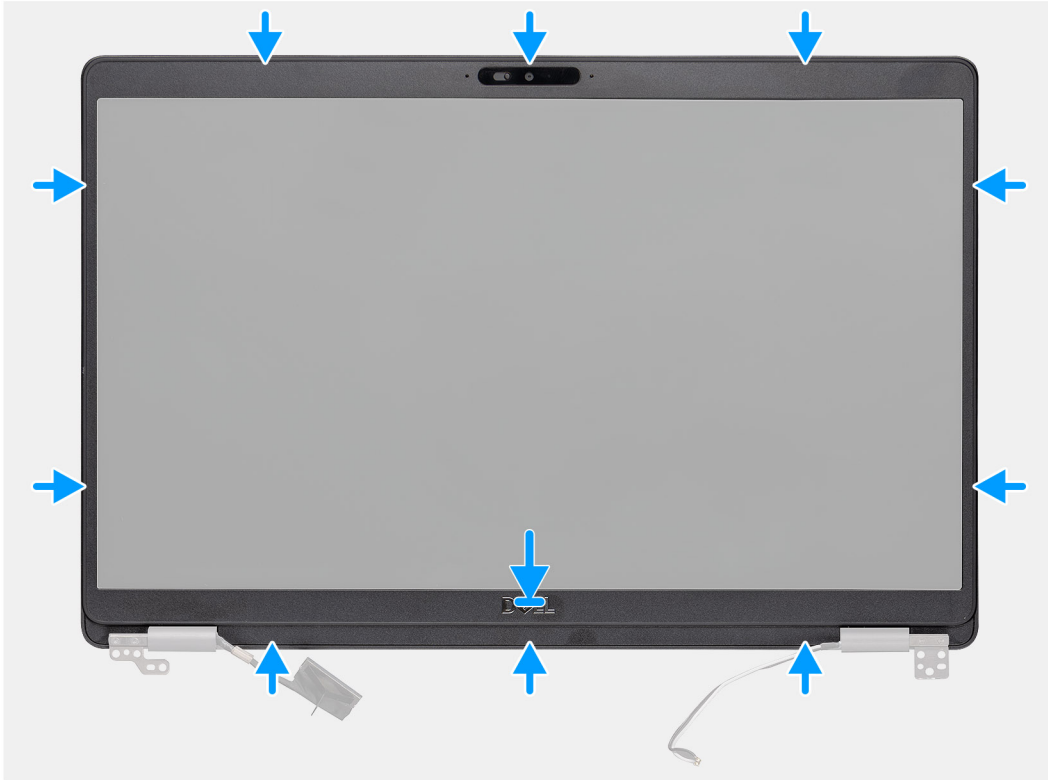

Steps

Align the display bezel with the display back-cover and antenna assembly, and gently snap the display bezel into place.

Next steps

1. Install the [display assembly](#).
2. Install the [WWAN card](#).
3. Install the [WLAN card](#).
4. Install the [battery](#).
5. Install the [base cover](#).
6. Follow the procedure in [After working inside your computer](#).

Hinge caps

Removing the hinge caps

Prerequisites

1. Follow the procedure in [Before working inside your computer](#).
2. Remove the [base cover](#).
3. Remove the [battery](#).
4. Remove the [display assembly](#).
5. Remove the [display bezel](#).

About this task

The figure indicates the location of the hinge caps and provides a visual representation of the removal procedure.



2x
M2x2.5

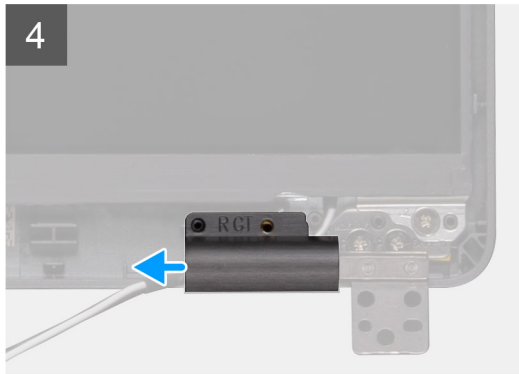
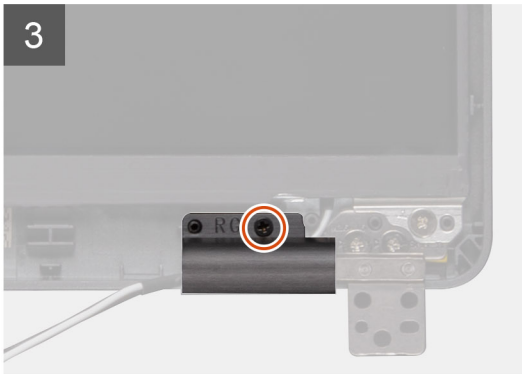
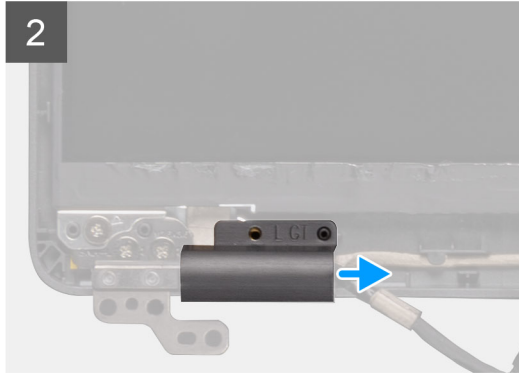
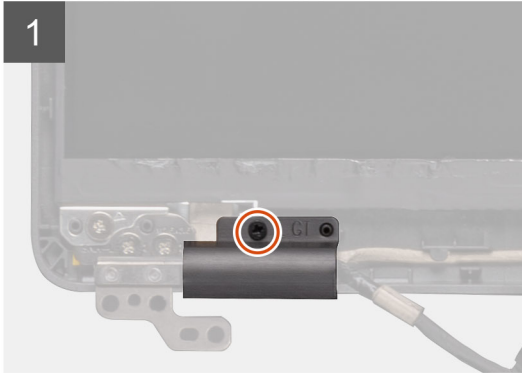

2x
M2x2.5

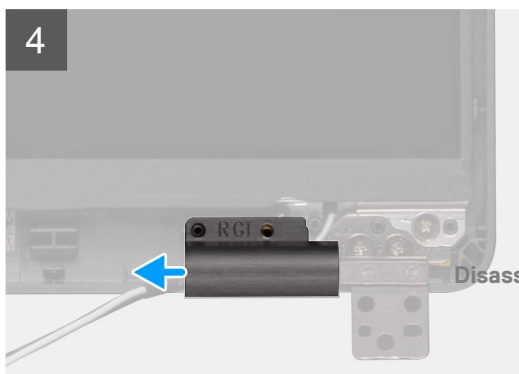
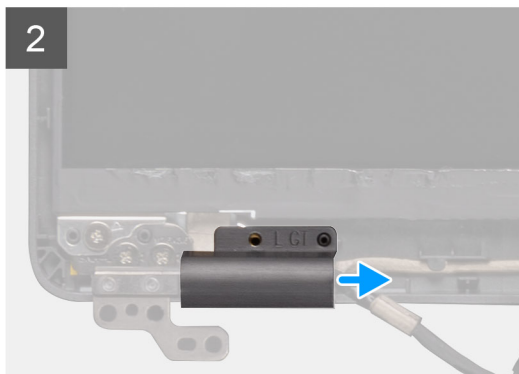
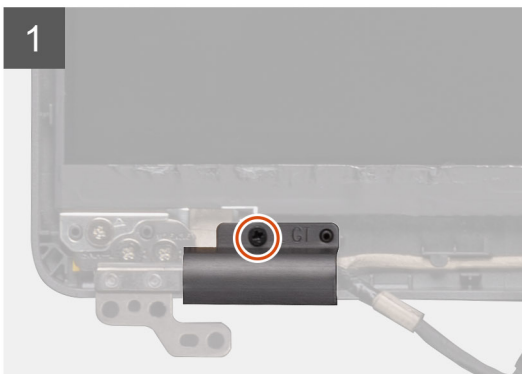

Steps

1. Locate the hinge cap on the display back cover.
2. Remove the two (M2x2.5) screws that secure the hinge caps to the chassis.
3. Pinch the hinge caps to release the hinge caps from the ribs on the display back cover and then slide inwards to remove the hinge caps from the display hinge.

Installing the hinge caps

Prerequisites

If you are replacing a component, remove the existing component before performing the installation procedure.

About this task

The figure indicates the location of the hinge caps and provides a visual representation of the installation procedure.



2x
M2x2.5

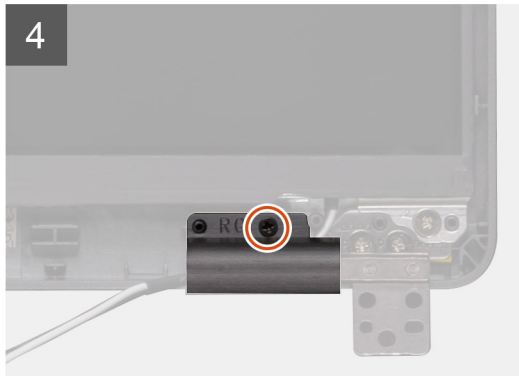
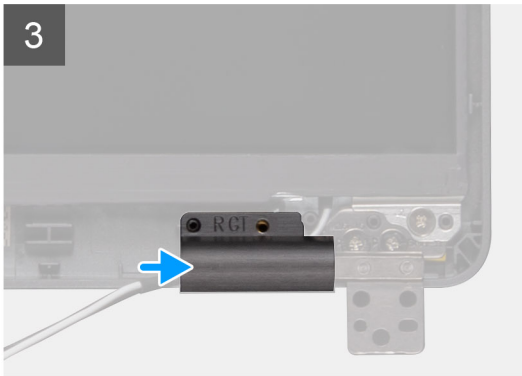
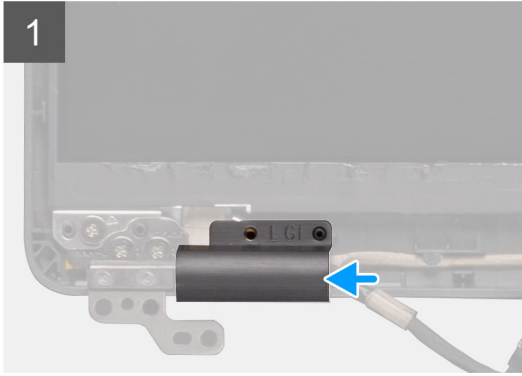

2x
M2x2.5

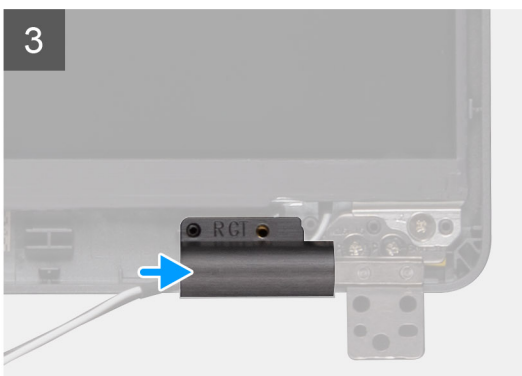
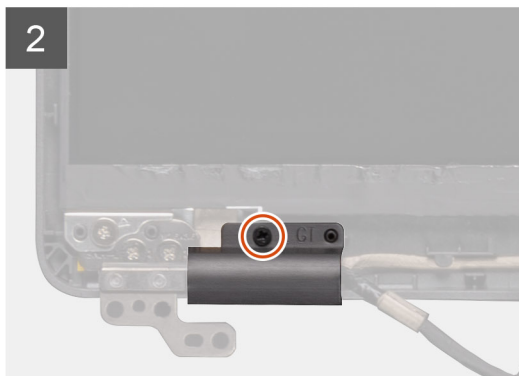
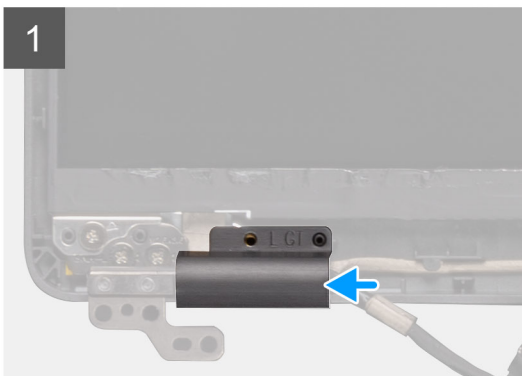

Steps

1. Place the hinge caps and slide outward on the display hinges.
2. Replace the two (M2x2.5) screws to secure the hinge caps to the display hinge.

Next steps

1. Install the [display bezel](#).
2. Install the [display assembly](#).
3. Install the [WWAN card](#).
4. Install the [WLAN card](#).
5. Install the [battery](#).
6. Install the [base cover](#).
7. Follow the procedure in [After working inside your computer](#).

Display panel

Removing the display panel

Prerequisites

1. Follow the procedure in [Before working inside your computer](#).
2. Remove the [base cover](#).
3. Remove the [battery](#).
4. Remove the [WLAN card](#).
5. Remove the [WWAN card](#).
6. Remove the [display assembly](#).
7. Remove the [display bezel](#).
8. Remove the [hinge caps](#).

About this task

The figure indicates the location of the display panel and provides a visual representation of the removal procedure.



4x
M2.5x3.5



1



2

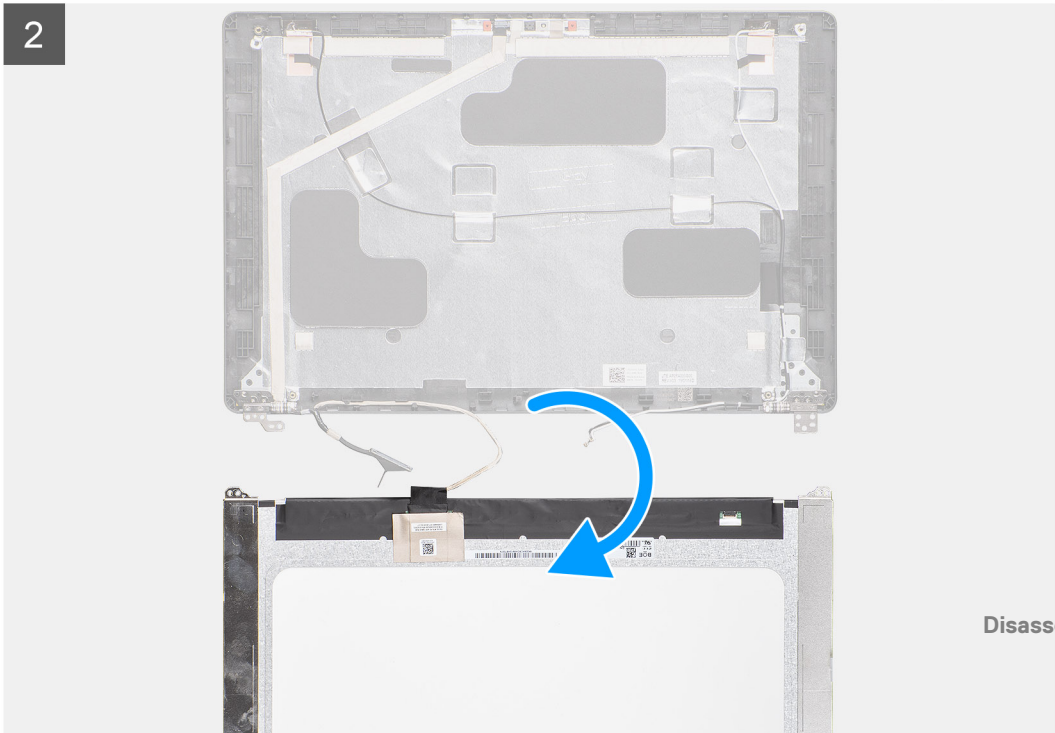

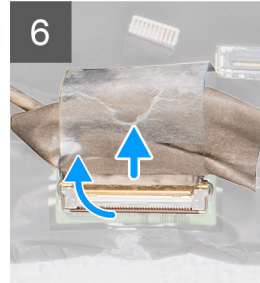
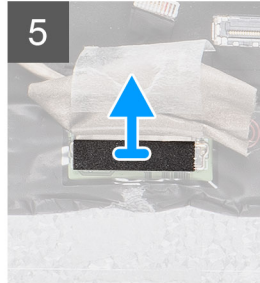
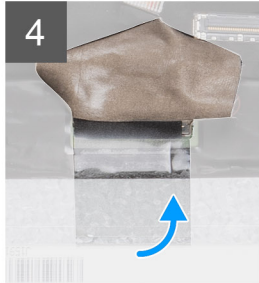



4x
M2.5x3.5



1



2

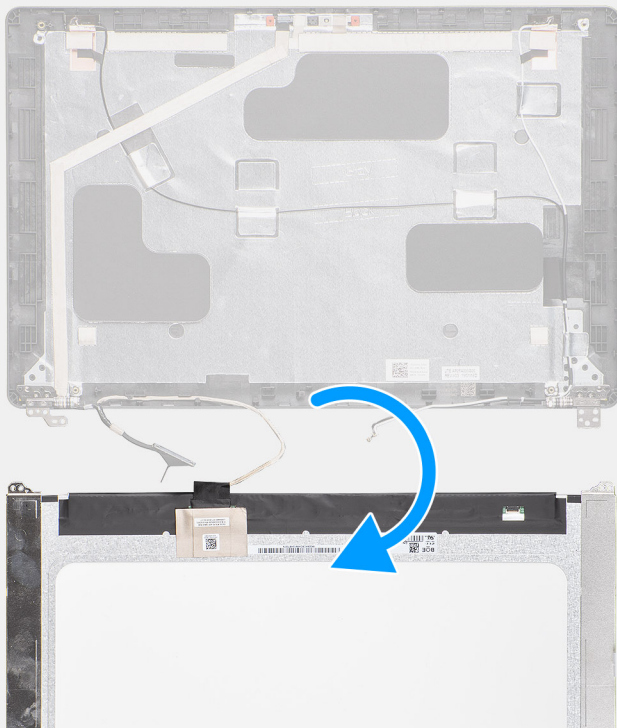

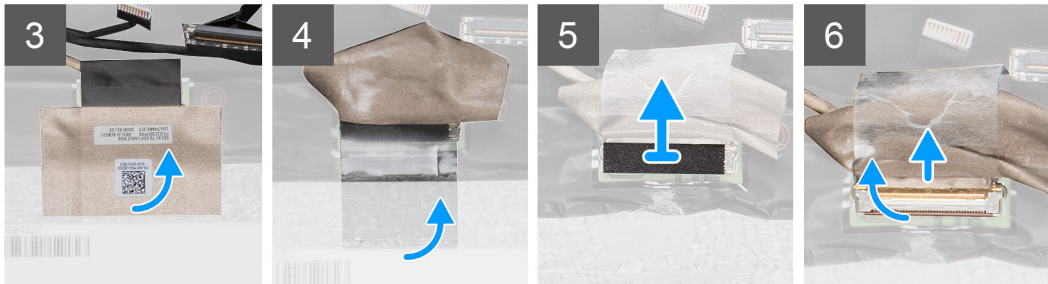

Steps

1. Locate the display panel on the display back cover assembly.
2. Remove the four (M2.5x3.5) screws that secure the display panel to the display assembly.
3. Lift to turn over the display panel to access the display cable.
4. Peel the conductive tape on the display cable connector.
5. Lift the latch and disconnect the display cable from the connector on the display panel.

NOTE: Do not pull and release the Stretch (SR) Tapes from the display panel. There is no need to separate the brackets from the display panel.

Installing the display panel

Prerequisites

If you are replacing a component, remove the existing component before performing the installation procedure.

About this task

The figure indicates the location of the display panel and provides a visual representation of the installation procedure.

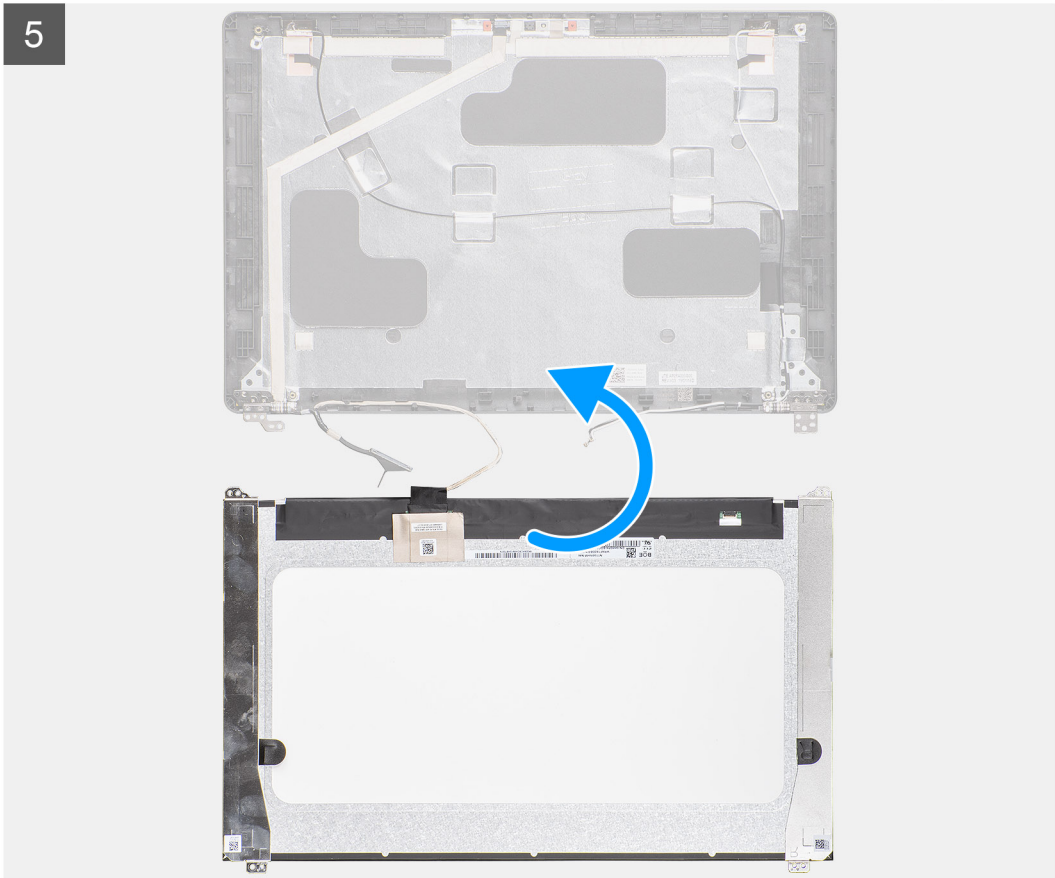
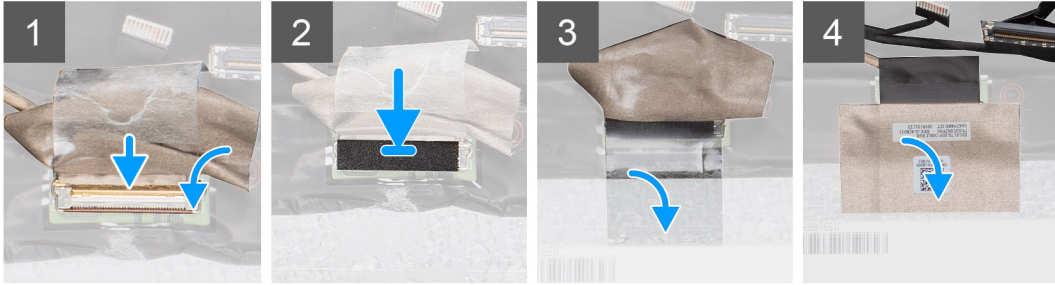

4x
M2.5x3.5



Disassembly and reassembly



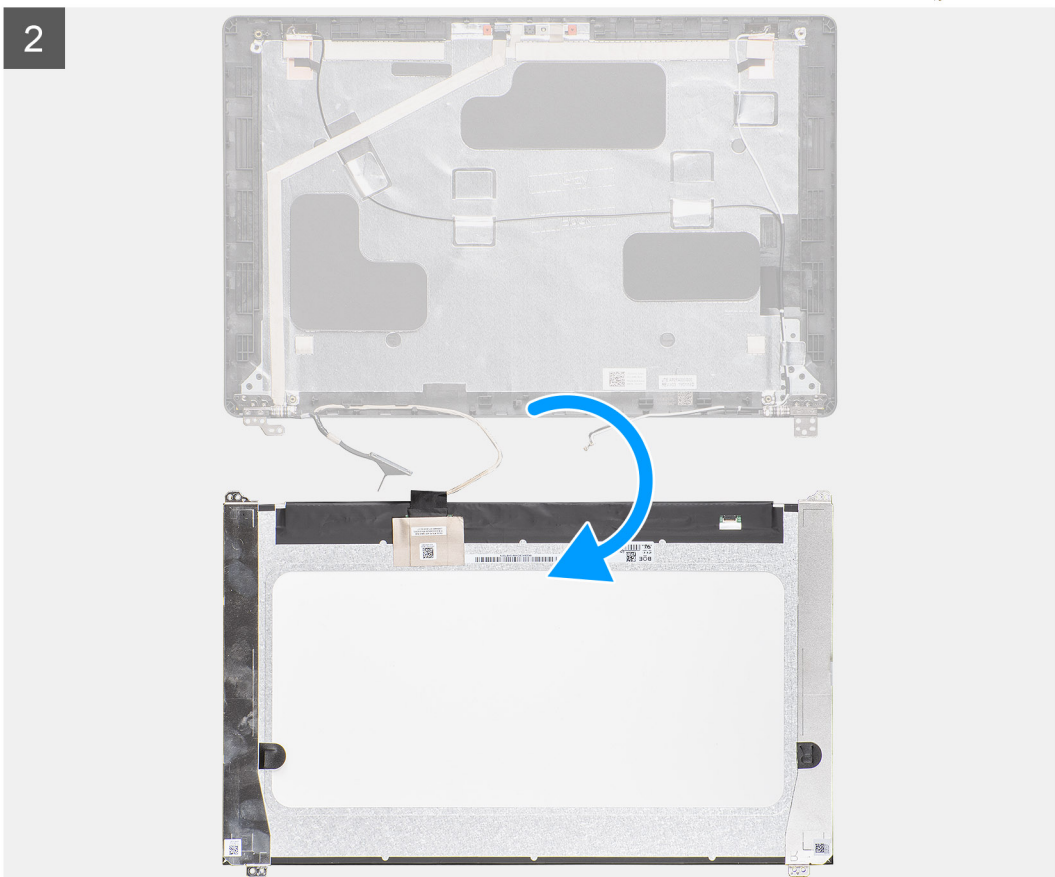
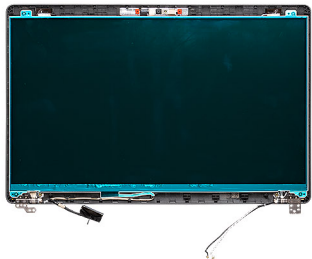
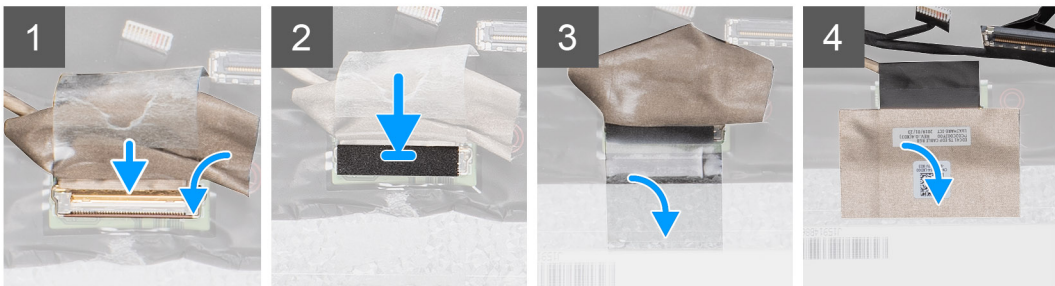

4x
12x1/2.5x0.5
Disassembly and reassembly



Steps

1. Connect the display cable to the connector and close the latch.
2. Adhere the adhesive strip to secure the display cable connector.
3. Adhere the conductive tape to secure the display cable connector.
4. Replace the four (M2.5x3.5) screws that secure the display panel to the display assembly.

Next steps

1. Install the [hinge caps](#).
2. Install the [display bezel](#).
3. Install the [display assembly](#).
4. Install the [WWAN card](#).
5. Install the [WLAN card](#).
6. Install the [battery](#).
7. Install the [base cover](#).
8. Follow the procedure in [After working inside your computer](#).

Palmrest assembly

Removing the palm-rest and keyboard assembly

Prerequisites

1. Follow the procedure in [Before working inside your computer](#).
2. Remove the [base cover](#).
3. Remove the [battery](#).
4. Remove the [solid state drive](#).
5. Remove the [HDD](#).
6. Remove the [WLAN card](#).
7. Remove the [WWAN card](#).
8. Remove the [inner frame](#).
9. Remove the [memory module](#).
10. Remove the [LED board](#).
11. Remove the [speakers](#).
12. Remove the [display assembly](#).
13. Remove the [power button with fingerprint reader](#).
14. Remove the [DC-in port](#).
15. Remove the [touchpad](#).
16. Remove the [system board](#).

 **NOTE:** The system board can be removed along with the heat sink.

About this task

The figure indicates the location of the palm-rest and keyboard assembly and provides a visual representation of the removal procedure.

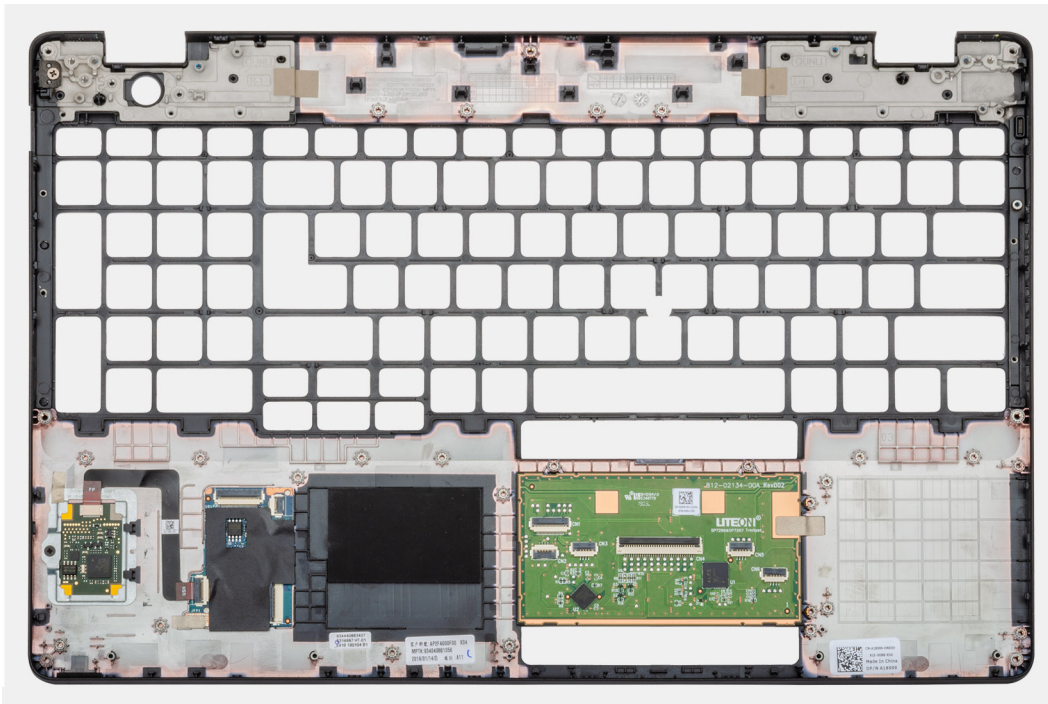
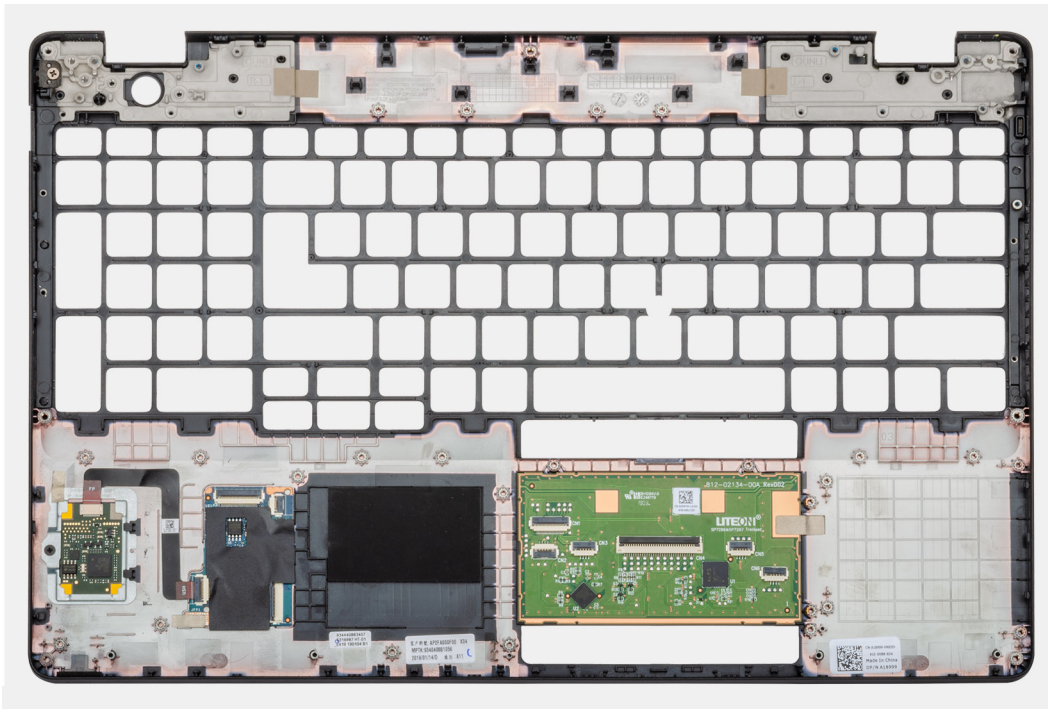

Steps

After performing the steps in the pre-requisites, we are left with the palm-rest and keyboard assembly.

Installing the palm-rest and keyboard assembly

Prerequisites

If you are replacing a component, remove the existing component before performing the installation procedure.

About this task

The figure indicates the location of the palm-rest and keyboard assembly and provides a visual representation of the installation procedure.

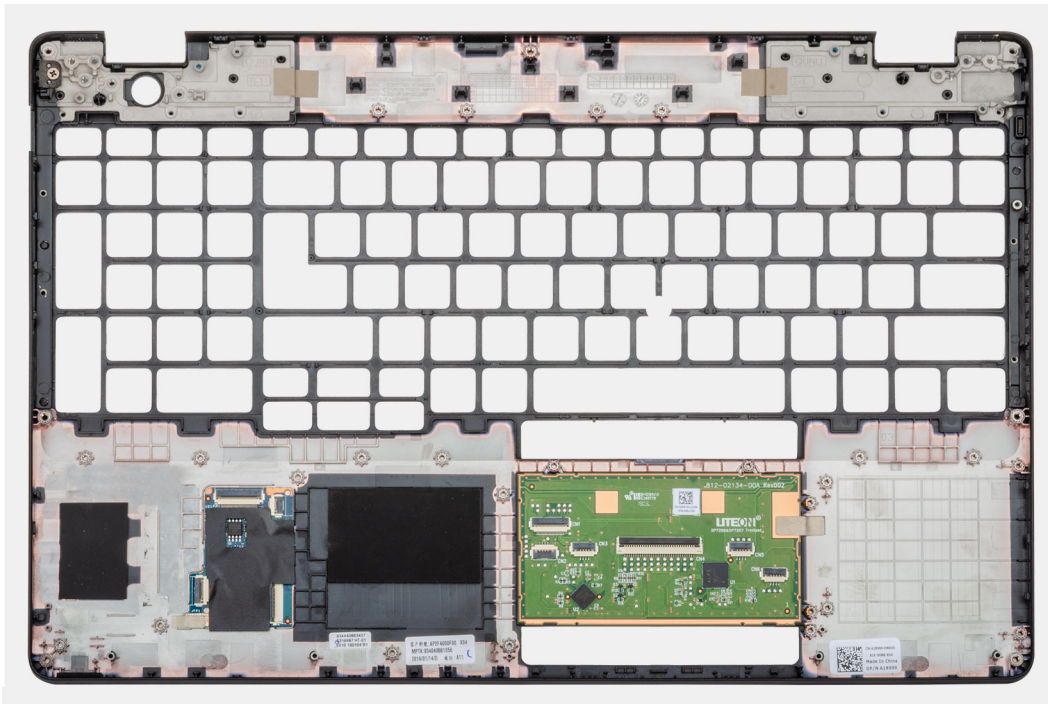
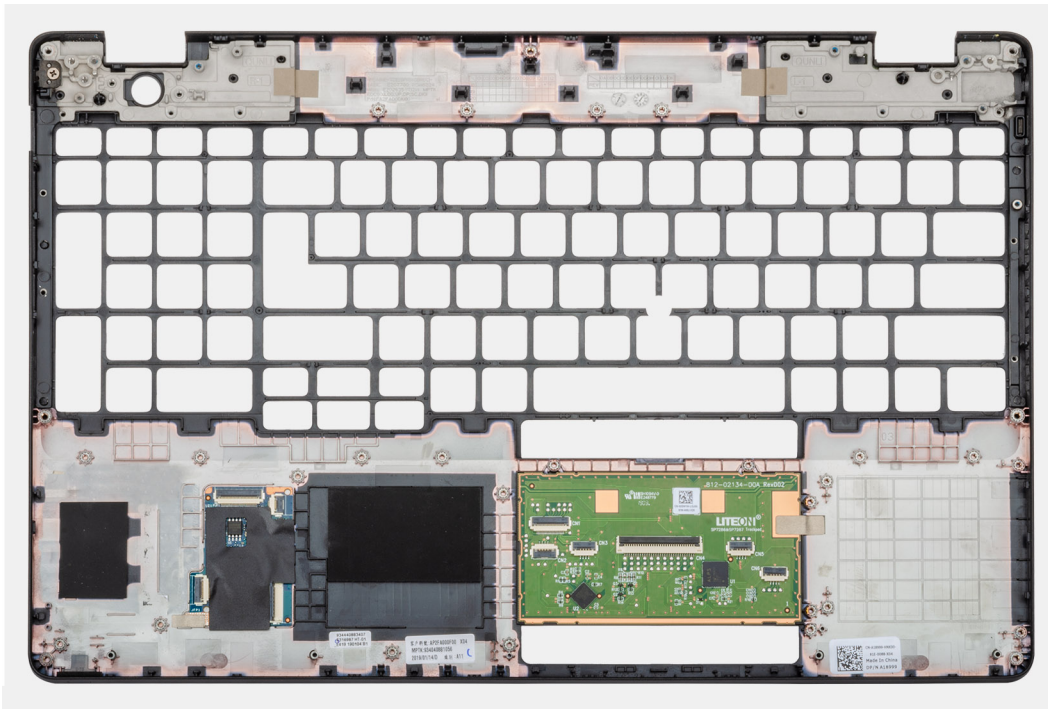

Steps

Place the palm-rest and keyboard assembly on a flat surface.

Next steps

1. Install the [system board](#).
2. Install the [touchpad](#).
3. Install the [DC-in port](#).
4. Install the [power button with fingerprint reader](#).
5. Install the [display assembly](#).
6. Install the [speakers](#).
7. Install the [LED board](#).

8. Install the [memory module](#).
9. Install the [inner frame](#).
10. Install the [WWAN card](#).
11. Install the [WLAN card](#).
12. Install the [HDD](#).
13. Install the [solid state drive](#).
14. Install the [battery](#).
15. Install the [base cover](#).
16. Follow the procedure in [After working inside your computer](#).

Troubleshooting

Enhanced Pre-Boot System Assessment (ePSA) diagnostics

About this task

The ePSA diagnostics (also known as system diagnostics) performs a complete check of your hardware. The ePSA is embedded with the BIOS and is launched by the BIOS internally. The embedded system diagnostics provides a set of options for particular devices or device groups allowing you to:

- Run tests automatically or in an interactive mode
- Repeat tests
- Display or save test results
- Run thorough tests to introduce additional test options to provide extra information about the failed device(s)
- View status messages that inform you if tests are completed successfully
- View error messages that inform you of problems encountered during testing

NOTE: Some tests for specific devices require user interaction. Always ensure that you are present at the computer terminal when the diagnostic tests are performed.

For more information, see [Dell EPSA Diagnostic 3.0](#).

Running the ePSA diagnostics

Steps

1. Turn on your computer.
2. As the computer boots, press the F12 key as the Dell logo appears.
3. On the boot menu screen, select the **Diagnostics** option.
4. Click the arrow at the bottom left corner.
Diagnostics front page is displayed.
5. Click the arrow in the lower-right corner to go to the page listing.
The items detected are listed.
6. To run a diagnostic test on a specific device, press Esc and click **Yes** to stop the diagnostic test.
7. Select the device from the left pane and click **Run Tests**.
8. If there are any issues, error codes are displayed.
Note the error code and validation number and contact Dell.

System diagnostic lights

Battery-status light

Indicates the power and battery-charge status.

Solid white — Power adapter is connected and the battery has more than 5 percent charge.

Amber — Computer is running on battery and the battery has less than 5 percent charge.

Off

- Power adapter is connected and the battery is fully charged.
- Computer is running on battery and the battery has more than 5 percent charge.
- Computer is in sleep state, hibernation, or turned off.

The power and battery-status light blinks amber along with beep codes indicating failures.

For example, the power and battery-status light blinks amber two times followed by a pause, and then blinks white three times followed by a pause. This 2,3 pattern continues until the computer is turned off indicating no memory or RAM is detected.

The following table shows different power and battery-status light patterns and associated problems.

Table 2. LED codes

Diagnostic light codes	Problem description
2,1	Processor failure
2,2	System board: BIOS or ROM (Read-Only Memory) failure
2,3	No memory or RAM (Random-Access Memory) detected
2,4	Memory or RAM (Random-Access Memory) failure
2,5	Invalid memory installed
2,6	System-board or chipset error
2,7	Display failure
2,8	LCD power rail failure. Replace system board
3,1	Coin-cell battery failure
3,2	PCI, video card/chip failure
3,3	Recovery image not found
3,4	Recovery image found but invalid
3,5	Power-rail failure
3,6	System BIOS Flash incomplete
3,7	Management Engine (ME) error

Camera status light: Indicates whether the camera is in use.

- Solid white — Camera is in use.
- Off — Camera is not in use.

Caps Lock status light: Indicates whether Caps Lock is enabled or disabled.

- Solid white — Caps Lock enabled.
- Off — Caps Lock disabled.

WiFi power cycle

About this task

If your computer is unable to access the internet due to WiFi connectivity issues a WiFi power cycle procedure may be performed. The following procedure provides the instructions on how to conduct a WiFi power cycle:

 **NOTE: Some ISPs (Internet Service Providers) provide a modem/router combo device.**

Steps

1. Turn off your computer.
2. Turn off the modem.
3. Turn off the wireless router.
4. Wait for 30 seconds.
5. Turn on the wireless router.
6. Turn on the modem.
7. Turn on your computer.

Getting help

Topics:

- [Contacting Dell](#)

Contacting Dell

Prerequisites

 **NOTE:** If you do not have an active Internet connection, you can find contact information on your purchase invoice, packing slip, bill, or Dell product catalog.

About this task

Dell provides several online and telephone-based support and service options. Availability varies by country and product, and some services may not be available in your area. To contact Dell for sales, technical support, or customer service issues:

Steps

1. Go to **Dell.com/support**.
2. Select your support category.
3. Verify your country or region in the **Choose a Country/Region** drop-down list at the bottom of the page.
4. Select the appropriate service or support link based on your need.